

Audio Distribution Network



System instruction manual

Contents

- Important safety instructions 4**
- The Sennheiser ADN conference system 7**
- Available system components – package contents 8**
- Overview of the components 10**
 - ADN D1 delegate unit 12
 - ADN C1 chairperson unit 13
 - ADN-W D1 wireless delegate unit 14
 - ADN-W C1 wireless chairperson unit 15
 - ADN-W BA Lithium-Ion battery pack 16
 - ADN-W MIC 15/ADN-W MIC 36 gooseneck microphones for wireless conference units 17
 - ADN-W AM antenna module 18
 - NT 12-50C power supply 19
 - ADN CU1 central unit 20
 - “Conference Manager” software 22
 - ADN PS power supply 23
 - SDC CBL RJ-45 system cables 24
 - ADN-W L 10 charger 24
 - ADN-W CASE transport and charging case 26
- Structuring and controlling the conference system 28**
 - Number of chairperson and delegate units 28
 - Calculating the voltage supply of the wired conference units and system components 28
 - Setting up a wired conference system 29
 - Setting up a wireless conference system 32
 - Combining wired and wireless conference units (hybrid operation) 33
 - Configuring and controlling the conference system 34
 - Input and output of audio signals 34
 - Integration into a media control system 34
- Using the ADN Cable Calculator software 35**
 - System requirements 35
 - Installing the ADN Cable Calculator 35
 - Using the ADN Cable Calculator 37
 - Uninstalling the ADN Cable Calculator 37
- Putting the conference system into operation 38**
 - Preparing the ADN CU1 central unit for operation 38
 - Preparing the ADN PS power supply for operation 40
 - Preparing the ADN-W AM antenna module for operation 42
 - Preparing the ADN C1/ADN D1 wired conference units for operation 44
 - Preparing the ADN-W C1/D1 wireless conference units for operation 46
 - Preparing the ADN-W L 10 charger for operation 48
 - Preparing the ADN-W CASE UNITS charging case for operation 49
 - Charging the ADN-W BA battery pack 51
 - Setting up the conference system 56
 - Connecting the ADN-W AM antenna module to the ADN CU1 central unit 66
 - Setting up and positioning the antenna module 69

- Setting up the ADN-W C1 or ADN-W D1 wireless conference units 74
- Connecting external audio devices to the central unit 75
- Connecting a USB mass storage device for audio recordings to the central unit .. 75
- Preparing to use the "Conference Manager" software 76
- Switching the conference system on/off 77
- Using the media control system 80
- Configuring the wireless components 81**
- Using the central unit 83**
 - Deactivating the lock mode of the central unit 83
 - Functions of the keys 83
- Configuring the conference system via the central unit 84**
 - Overview of the operating menu 84
 - Working with the operating menu 88
 - Adjusting the conference settings – "Conference Menu" 90
 - Adjusting the radio settings – "Wireless Menu" 95
 - Adjusting the audio settings – "Audio Menu" 97
 - Checking the system and detecting errors – "System Menu" 102
 - Adjusting the language – "*Language" 113
 - Adjusting further settings – "Settings" 113
- Running a conference 115**
 - Operating a delegate unit 116
 - Operating a chairperson unit 118
 - Setting the volume of the conference units' built-in loudspeakers 120
 - Adding conference units to the conference system during operation 121
 - Recording a conference 122
- Using the "Conference Manager" software 125**
 - Possibilities of usage of the software and the conference system 125
 - Preparing the central unit's integrated software for use 126
 - Preparing the Windows version of the software for use 127
 - Starting/exiting the software 143
 - Getting to know and adjusting the basic features of the software 144
 - Using the conference system and the software 154
 - Configuring the settings for wireless conferencing 160
 - Preparing a conference and mapping a conference room – "Setup" operating mode 172
 - Initializing the conference units – "Setup" operating mode 189
 - Adjusting the conference settings – "Setup" operating mode 195
 - Controlling and monitoring a conference – "Live" operating mode 203
 - Adding conference units to the conference system during operation 213
 - Adjusting settings during a running conference 214
 - Exiting "Live" operating mode 216
 - Recording a conference – "Conference Recording" 217
 - Using the log and diagnosis function – "Event Log" 219
- Cleaning and maintaining the conference system 225**
- Transporting the wireless components 227**
 - Preparing the wireless components for transport 227
 - Using the ADN-W CASE transport and charging case 227

Updating the firmware of the conference system	230
If a problem occurs .../Frequently asked questions	231
Components and accessories	237
Specifications	240
Appendix	248
Mounting dimensions	248
RF channels and transmission powers for wireless conferencing	251
Factory default settings	253
Keyboard layouts	254
Microsoft Software License Terms	254
Manufacturer Declarations	257
Index – ADN conference system	259
Index – “Conference Manager” software	263

Important safety instructions

1. Read this system manual.
2. Keep this system manual. Always include the system manual when passing the apparatus on to third parties.
3. Heed all warnings.
4. Follow all instructions.
5. Do not use the apparatus near water.
6. Clean only with a dry cloth.
7. Do not block any ventilation openings. Install in accordance with the manufacturer's instructions.
8. Do not install near any heat sources such as radiators, heat registers, stoves, or other apparatus (including amplifiers) that produce heat.
9. Do not defeat the safety purpose of the polarized or grounding-type plug. A polarized plug has two blades with one wider than the other. A grounding type plug has two blades and a third grounding prong. The wide blade or the third prong are provided for your safety. If the provided plug does not fit into your outlet, consult an electrician for replacement of the obsolete outlet.
10. Protect the power cord from being walked on or pinched, particularly at plugs, convenience receptacles, and the point where it exits from the apparatus.
11. Only use attachments/accessories specified by the manufacturer.
12. Use only with the cart, stand, tripod, bracket, or table specified by the manufacturer, or sold with the apparatus. When a cart is used, use caution when moving the cart/apparatus combination to avoid injury from tip-over.
13. Unplug the apparatus during lightning storms or when unused for long periods of time.
14. Refer all servicing to qualified service personnel.
15. Servicing is required when the apparatus has been damaged in any way, such as power supply cord or plug is damaged, liquid has been spilled or objects have fallen into the apparatus, when the apparatus has been exposed to rain or moisture, does not operate normally, or has been dropped.
16. To completely disconnect the apparatus from the AC mains, disconnect the power supply cord plug from the AC receptacle.
17. **WARNING:** To reduce the risk of fire or electric shock, do not expose the apparatus to rain or moisture.
18. Do not expose the apparatus to dripping or splashing and ensure that no objects filled with liquids, such as vases, are placed on the apparatus.
19. The mains plug of the power supply cord shall remain readily accessible.





Hazard warnings on the rear of products with mains plug

The label shown on the left is attached to the rear of products with mains plug (ADN CU1 central unit, ADN PS power supplies, ADN-W L10 chargers and ADN-W CASE UNITS). The symbols on this label have the following meaning:

Presence of uninsulated dangerous voltage within the product's enclosure (ADN CU1 central unit, ADN PS power supplies, ADN-W L10 chargers and ADN-W CASE UNITS) that may be of sufficient magnitude to constitute risk of electric shock.

Never open the ADN CU1 central unit, the ADN PS power supplies, the ADN-W L10 chargers and the ADN-W CASE UNITS as there is a risk of electric shock. There are no user serviceable parts inside. Refer servicing to an authorized Sennheiser service partner.

Read and follow the safety and operating instructions contained in the instruction manual.

Risk of fire due to overloading

Do not overload wall outlets and extension cables as this may result in fire and electric shock.

Danger of hearing damage due to high volumes

These products are used for commercial purposes. Commercial use is subject to the rules and regulations of the trade association responsible. Sennheiser, as the manufacturer, is therefore obliged to expressly point out possible health risks arising from use.

When the conference participants listen to the floor channel via headphones, they can adjust the volume themselves. In doing so, sound pressure exceeding 85 dB(A) can be produced. 85 dB(A) is the sound pressure corresponding to the maximum permissible volume which is by law (in some countries) allowed to affect your hearing for the duration of a working day. It is used as a basis according to the specifications of industrial medicine. Higher volumes or longer durations can damage your hearing. At higher volumes, the duration must be shortened in order to prevent hearing damage. The following are sure signs that you have been subjected to excessive noise for too long a time:

- You can hear ringing or whistling sounds in your ears.
- You have the impression (even for a short time only) that you can no longer hear high notes.

Inform the conference participants about these facts and, if necessary, ask them to set the volume to a medium level.

Warning on the use of the wireless components

In some countries/regions and for certain radio channels, the use of wireless components is subject to special legal requirements. Only use the wireless components in accordance with these legal requirements in order to avoid interference to other radio equipment. Make sure to always set the correct country/region (via the operating menu of the ADN CU1 central unit) in which the wireless components are to be used. This ensures that the conference system uses only the radio settings (radio frequencies and transmission powers) that are approved and legal in the respective country.

In some countries/regions (e.g. Canada), the use of wireless components operating in the 5.15 to 5.25 GHz frequency band is restricted to indoor use.

Safety instructions for the Lithium-Ion battery pack

If abused or misused, the ADN-W BA battery pack may leak. In extreme cases, it may even present:



- a heat hazard,
- a fire hazard,
- an explosion hazard,
- a smoke or gas hazard.

Please understand that Sennheiser does not accept liability for damage arising from abuse or misuse.

	Keep away from children.		Do not pack charged battery packs loose.
	Observe correct polarity.		Do not short-circuit.
	Do not expose to moisture.		Do not mutilate or dismantle.
	Only charge the battery pack with the appropriate Sennheiser chargers.		When not using the battery pack for extended periods of time, charge it regularly (charge it to approx. 50% of capacity about every 3 months).
	Only charge the battery pack at ambient temperatures between 10°C/50°F and 45°C/113°F.		Do not heat above 45°C/113°F, e.g. do not expose to sunlight or throw into a fire.
	Immediately remove the battery pack from an obviously defective device.		Do not continue to use a defective battery pack.
	Switch battery pack-powered devices off after use.		When not using the device for extended periods of time, remove the battery pack from the device.
	Only use the original Sennheiser battery packs.		Dispose of the battery pack at special collection points or return it to your specialist dealer.

Intended use

Intended use of the products includes:

- using the products for professional purposes,
- having read and understood this system manual and especially the chapter “Important safety instructions” on page 4,
- using the products within the operating conditions and limitations described in this system manual.

“Improper use” means using the products other than as described in this system manual, or under operating conditions which differ from those described therein.

All instruction manuals for components of the ADN conference system are also available on the Internet at www.sennheiser.com.



The Sennheiser ADN conference system

Sennheiser ADN stands for Sennheiser Audio Distribution Network – the new generation of digital conference equipment. The ADN conference system has been designed for maximum versatility and can be easily adapted to many different requirements.

The conference system offers the following features:

- State-of-the-art conference technology for up to 400 participants
- Optimum speech intelligibility due to quality microphone and dual loudspeakers in each conference unit
- Attractive design – fits into modern or traditional style conference rooms
- High operational reliability due to state-of-the-art transmission technology
- Wired conference units and mobile wireless conference units enable quick and easy adaptation to different room sizes and participant numbers
- Fail-safe audio transmission due to redundant cabling or due to dynamic frequency management in a wireless conference system
- Intuitive configuration and control of the conference system via “Conference Manager” software or operating menu
- Audio recording of conferences on a USB mass storage device

The wireless components offer the following features:

- Dynamic frequency management for interference-free operation
- Can be used all over the world due to up to 28 license-free frequencies
- Secure data transmission with 128-bit-AES encryption
- Ease of use due to automatic configuration of the system
- Wireless conference units with up to 20 hrs operating time
- Easy expansion of the conference system and hybrid operation between wired and wireless conference units

Available system components – package contents

ADN wired standard components

ADN CU1 central unit	<ul style="list-style-type: none"> 1 ADN CU1 central unit 1 mains cable (with EU, UK or US mains plug, depending on version), length 1.8 m 1 instruction manual 1 “Safety information” supplement 1 DVD-ROM (including, among other things, the “Conference Manager” software, the “ADN Cable Calculator” software and the instruction manual for the overall conference system as PDF)
ADN PS power supply	<ul style="list-style-type: none"> 1 ADN PS power supply with premounted rack mount “ears” 1 mains cable (with EU, UK or US mains plug, depending on version), length 1.8 m 1 instruction manual 1 “Safety information” supplement
ADN D1 delegate unit	<ul style="list-style-type: none"> 1 ADN D1 delegate unit 1 instruction manual
ADN C1 chairman unit	<ul style="list-style-type: none"> 1 ADN C1 chairperson unit 1 instruction manual
System cable	SDC CBL RJ45, available in different lengths (2 m to 50 m, see “Components and accessories” on page 237)

ADN wireless components

ADN-W AM antenna module	<ul style="list-style-type: none"> 1 ADN-W AM antenna module with 3 rod antennas (ADN-W AM or ADN-W AM-US version) 1 SDC CBL RJ45-5 system cable, length 5 m 1 thread insert (5/8" to 3/8") 1 instruction manual
Console of the ADN-W D1 wireless delegate unit	<ul style="list-style-type: none"> 1 console of the ADN-W D1 wireless delegate unit (<i>without</i> battery pack and gooseneck microphone) 1 instruction manual
Console of the ADN-W C1 wireless chairperson unit	<ul style="list-style-type: none"> 1 console of the ADN-W C1 wireless chairperson unit (<i>without</i> battery pack and gooseneck microphone) 1 instruction manual
ADN-W BA battery pack for wireless conference units	<ul style="list-style-type: none"> 1 ADN-W BA Lithium-Ion battery pack 1 instruction manual
Gooseneck microphones for wireless conference units	<ul style="list-style-type: none"> 1 ADN-W MIC 15-39 (length 39 cm, KE 10 microphone capsule) or ADN-W MIC 36-29 (length 29 cm, ME 36 microphone capsule) or ADN-W MIC 15-50 (length 50 cm, KE 10 microphone capsule) or ADN-W MIC 36-50 (length 50 cm, ME 36 microphone capsule) 1 instruction manual
Wireless conference unit kit for delegate unit	<ul style="list-style-type: none"> 1 console of the ADN-W D1 wireless delegate unit 1 ADN-W BA battery pack 1 gooseneck microphone (ADN-W MIC 15-39 or 36-29, depending on version) 3 instruction manuals (one for the wireless conference unit, one for the battery pack and one for the gooseneck microphone)

NT 12-50C power supply	<p>Power supply for charging one ADN-W BA or for optionally powering the ADN-W AM antenna module</p> <ul style="list-style-type: none"> 1 NT 12-50C power supply 1 mains cable (with EU, UK or US mains plug, depending on version), length 2.5 m 1 instruction manual
ADN-W L 10 charger for charging up to 10 ADN-W BA battery packs	<ul style="list-style-type: none"> 1 ADN-W L 10 charger 1 mains cable (with EU, UK or US mains plug, depending on version), length 1.8 m 1 instruction manual 1 "Safety information" supplement

Transport components

The following transport components are available:

- ADN-W CASE BASE case bottom with wheels and case lid
- ADN-W CASE CENTRAL transport case for e.g. central unit, antenna module and accessories
- ADN-W CASE UNITS charging case with charging compartments for 10 wireless conference units



The modules can be used separately or be combined arbitrarily (see page 227).

ADN-W CASE UNITS charging case	<ul style="list-style-type: none"> 1 ADN-W CASE UNITS charging case with charging compartments for 10 wireless conference units 1 mains cable (with EU, UK or US mains plug, depending on version), length 1.8 m (also available without mains cable) 1 instruction manual 1 "Safety information" supplement
ADN-W CASE CENTRAL transport case	<ul style="list-style-type: none"> 1 ADN-W CASE CENTRAL transport case for e.g. central unit, antenna module and accessories
ADN-W CASE BASE case bottom and lid	<ul style="list-style-type: none"> 1 ADN-W CASE BASE including <ul style="list-style-type: none"> – case bottom with wheels – case lid
ADN-W CASE KIT 20 transport and charging case kit for 20 wireless conference units	<ul style="list-style-type: none"> 1 ADN-W CASE BASE case bottom with wheels and case lid 2 ADN-W CASE UNITS charging cases, each with charging compartments for 10 wireless conference units 2 mains cables (with EU, UK or US mains plug, depending on version), length 1.8 m (also available without mains cables) 1 instruction manual 1 "Safety information" supplement

Overview of the components

Components required for setting up a **wired** conference system:

- 1 ADN CU1 central unit
- ADN D1 delegate units (a maximum of 400 delegate units can be used in a conference system)
- ADN C1 chairperson units (optional, for granting speaking privileges, a maximum of 10 chairperson units can be used in a conference system)
- SDC CBL RJ-45 system cables (available in different lengths)
- ADN PS power supplies (optional, for conferences with up to 400 conference units connected in simple strings or in redundant ring topology; a maximum of 15 ADN PS can be used in a conference system – for the exact calculation, use the ADN Cable Calculator software)
- “Conference Manager” software for configuring and controlling conferences (optional)
 - can be run on the central unit (a screen, keyboard, and mouse are required)
 - or
 - can be run on a separate Windows PC with Ethernet connection

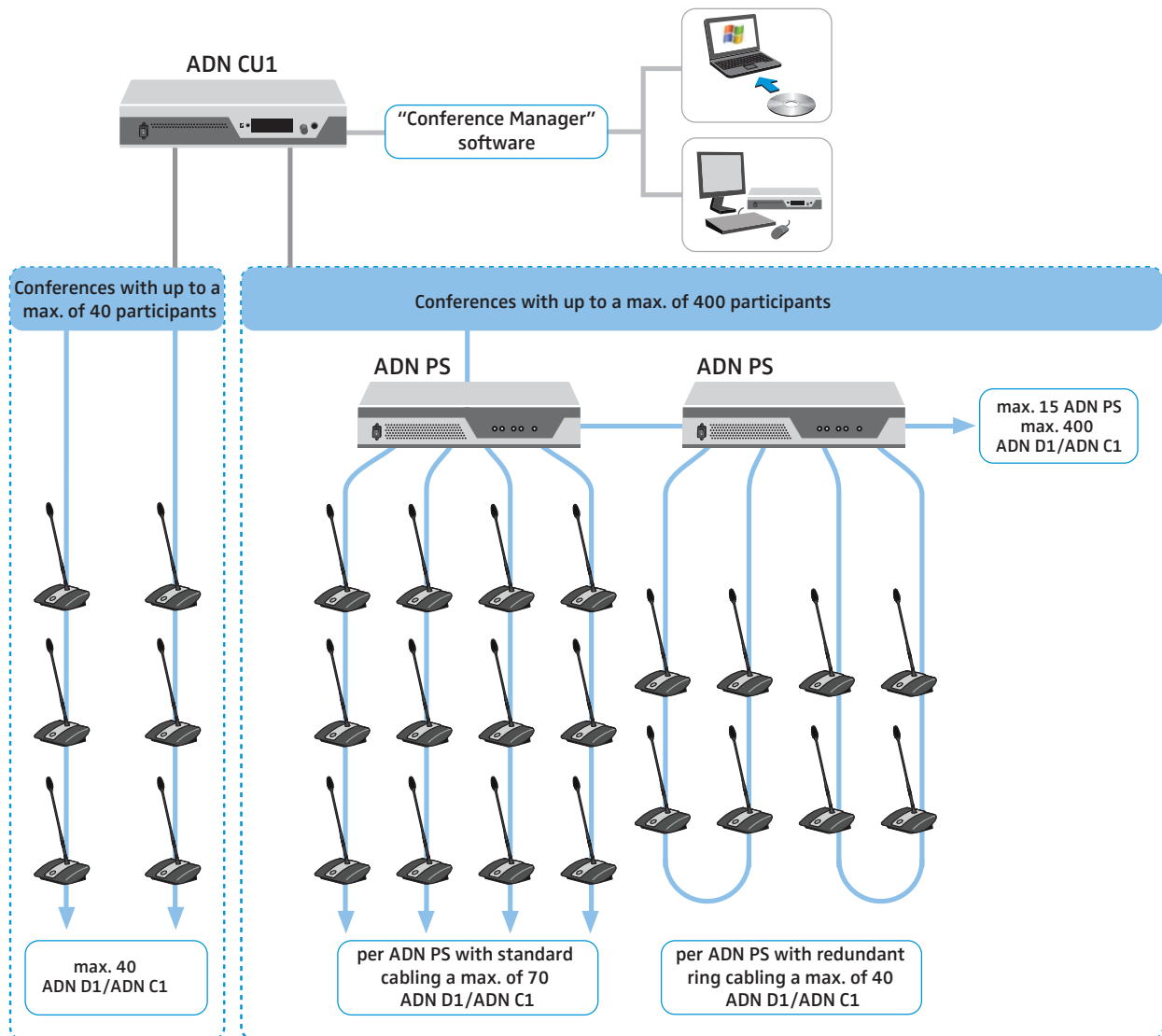

Components required for setting up a **wireless** conference system:

- 1 ADN CU1 central unit
- at least 1 ADN-W AM antenna module for operating the wireless conference units
- ADN-W D1 wireless delegate units (a maximum of 150 delegate units can be used in a conference system)
- ADN-W C1 wireless chairperson units (optional, for granting speaking privileges, a maximum of 10 chairperson units can be used in a conference system)
- "Conference Manager" software for configuring and controlling conferences (optional)
 - can be run on the central unit (a screen, keyboard, and mouse are required) or
 - can be run on a separate Windows PC with Ethernet connection

i ADN C1 and ADN D1 wired conference units and ADN-W C1 and ADN-W D1 wireless conference units can be combined arbitrarily as long as you ensure correct set-up and cabling and comply with the specifications (a conference system can comprise a total of 400 conference units of which up to 150 can be wireless, see page 56).

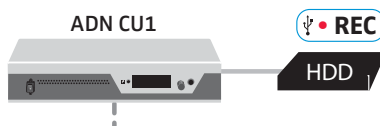
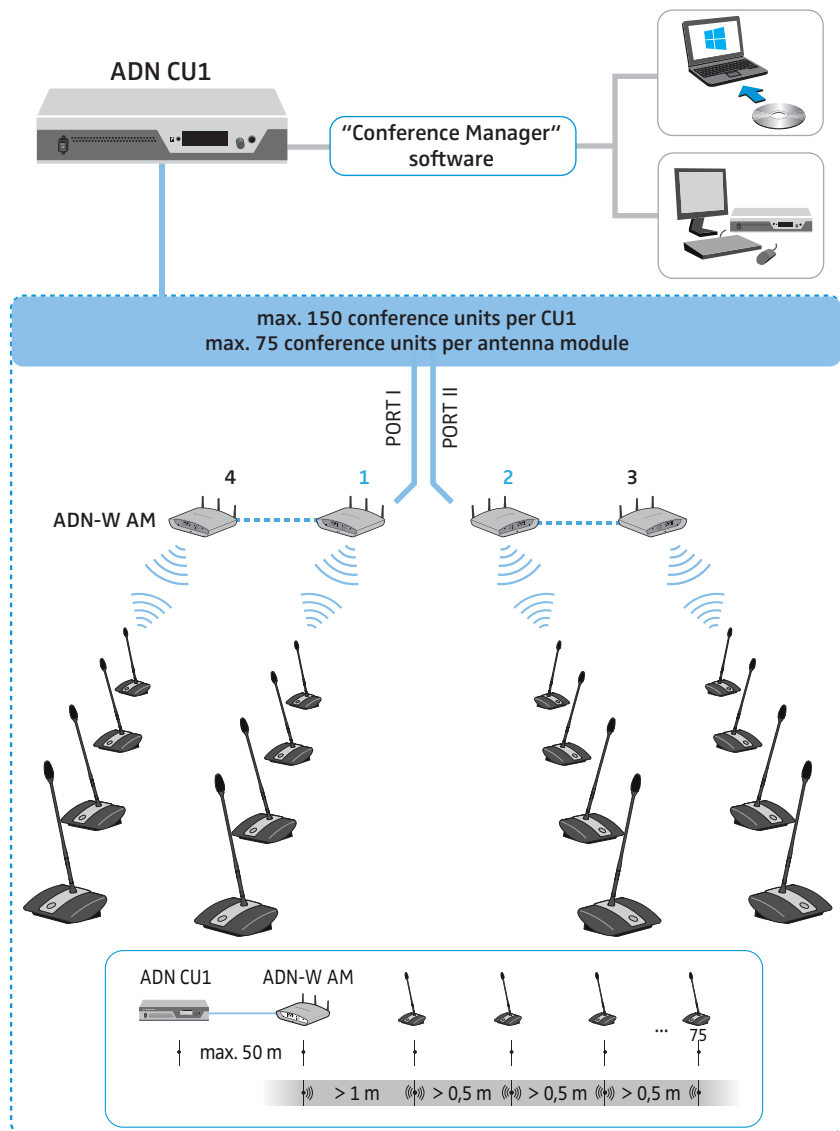

Component required for **audio recording** of conferences (optional):

- USB mass storage device (e.g. external hard disk)

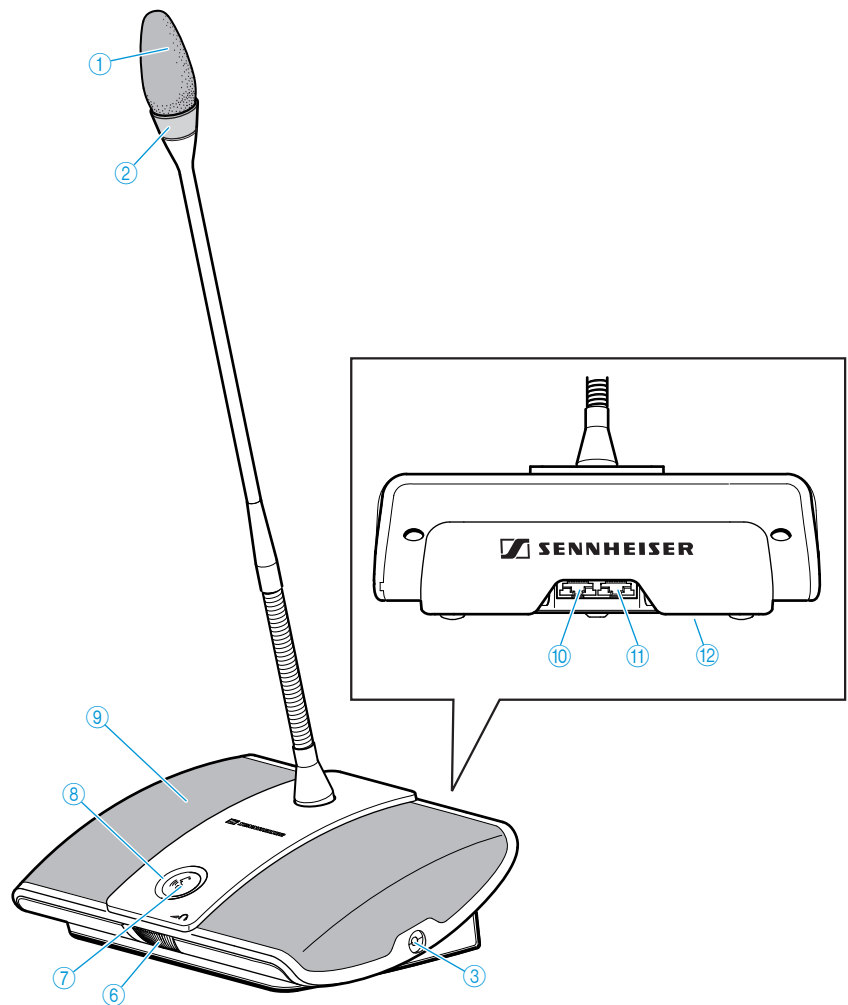

ADN D1 delegate unit

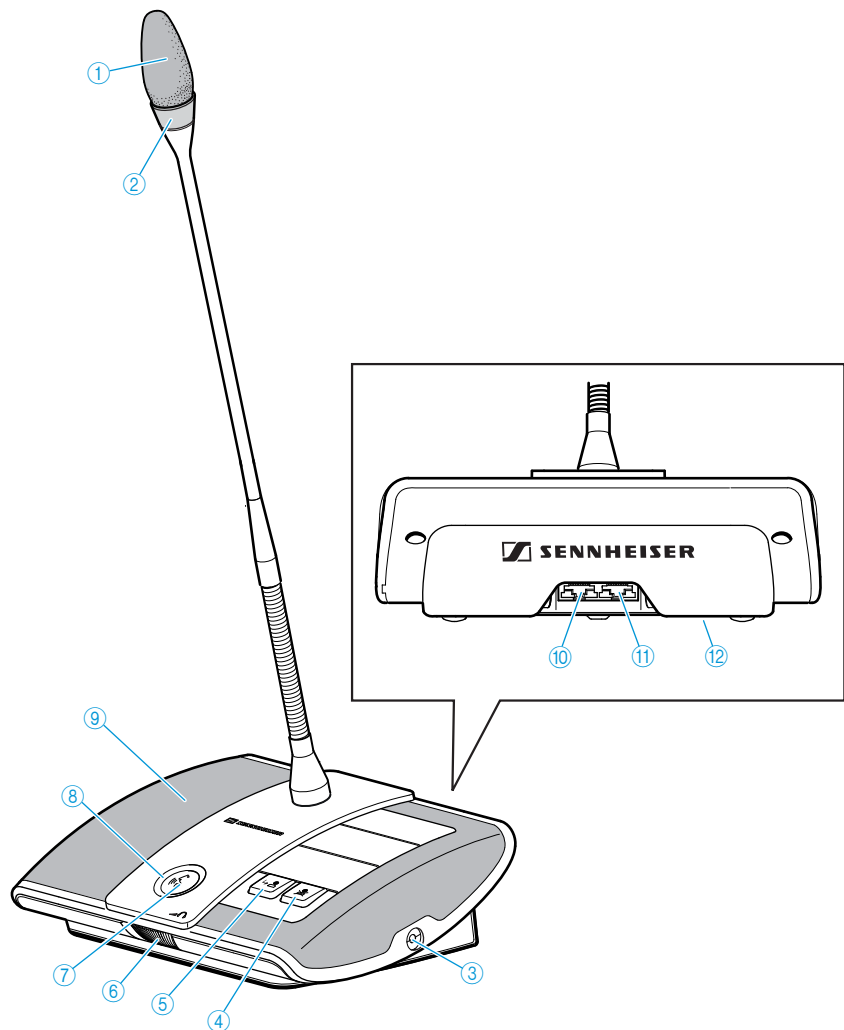

- ① Sound inlet basket with glued windshield
- ② Signal light ring
- ③ Headphone socket
- ⑥ Headphone volume control for headphone socket
- ⑦ Microphone key 
- ⑧ Microphone LED
- ⑨ Loudspeaker
- ⑩ IN socket
- ⑪ OUT socket
- ⑫ Type plate (see bottom)

ADN C1 chairperson unit



- ① Sound inlet basket with glued windshield
- ② Signal light ring
- ③ Headphone socket
- ④ Priority key 
- ⑤ Next key 
- ⑥ Headphone volume control for headphone socket
- ⑦ Microphone key 
- ⑧ Microphone LED
- ⑨ Loudspeaker
- ⑩ IN socket
- ⑪ OUT socket
- ⑫ Type plate (see bottom)

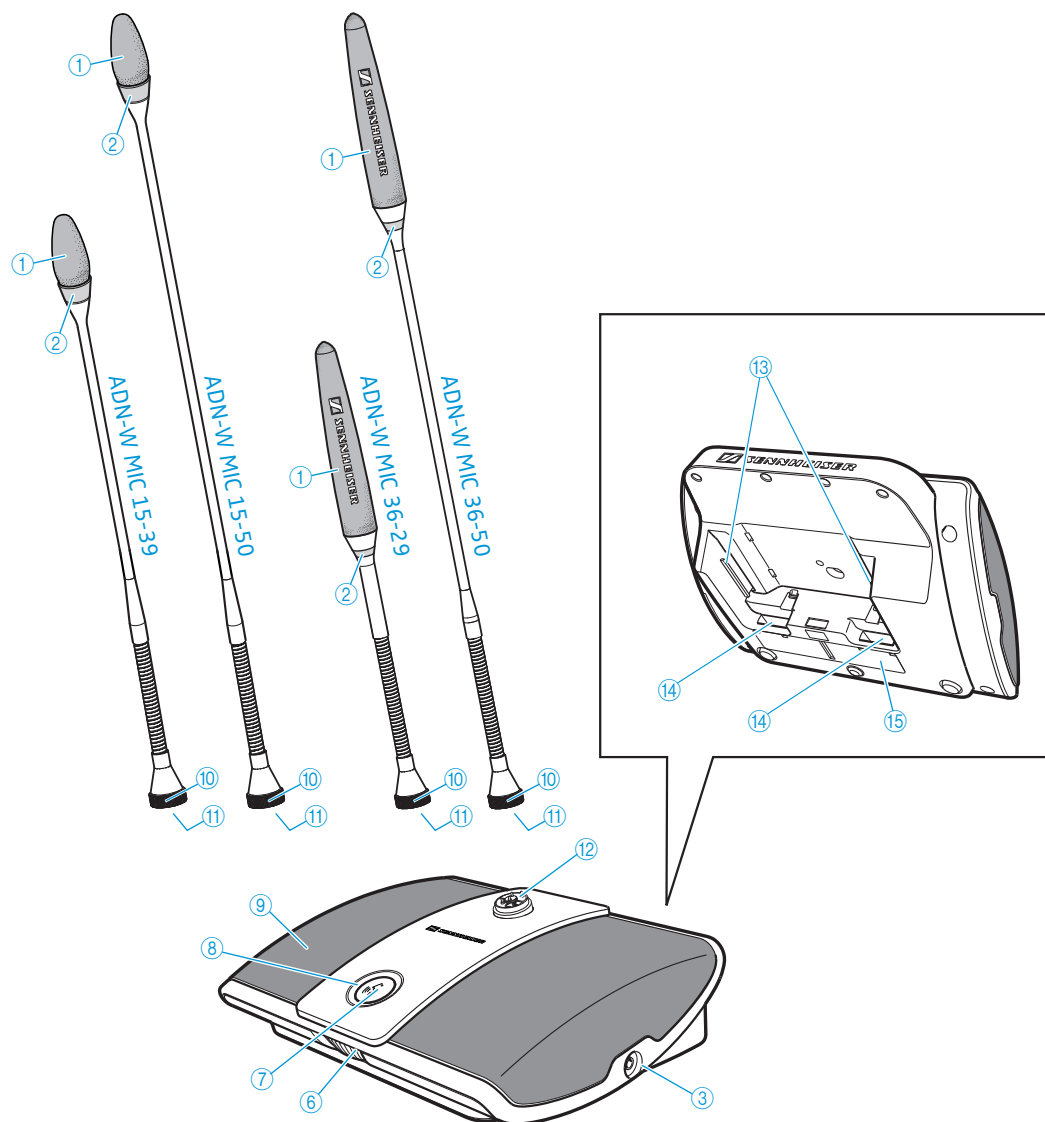

ADN-W D1 wireless delegate unit

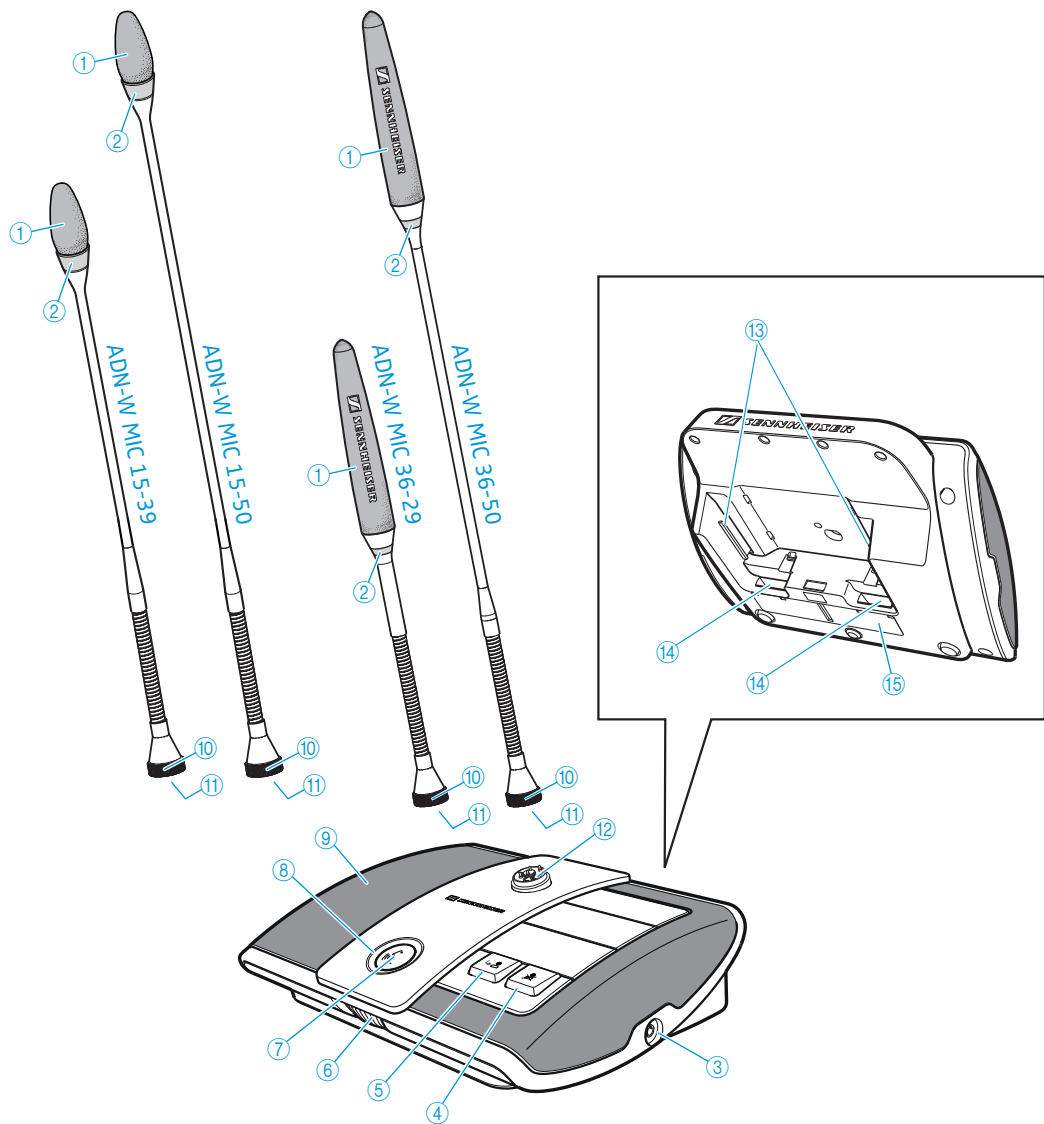

- | | |
|--|---|
| ① Sound inlet basket with glued windshield | ⑬ Guide rails for ADN-W BA battery pack |
| ② Signal light ring | ⑭ Connection for ADN-W BA battery pack |
| ③ Headphone socket | ⑮ Type plate |
| ⑥ Headphone volume control for headphone socket | |
| ⑦ Microphone key  | |
| ⑧ Microphone LED | |
| ⑨ Loudspeaker | |
| ⑩ Fastening thread | |
| ⑪ Sliding contacts | |
| ⑫ Microphone connection | |

ADN-W C1 wireless chairperson unit



- | | |
|--|---|
| ① Sound inlet basket with glued windshield | ⑬ Guide rails for ADN-W BA battery pack |
| ② Signal light ring | ⑭ Connection for ADN-W BA battery pack |
| ③ Headphone socket | ⑮ Type plate |
| ④ Priority key  | |
| ⑤ Next key  | |
| ⑥ Headphone volume control for headphone socket | |
| ⑦ Microphone key  | |
| ⑧ Microphone LED | |
| ⑨ Loudspeaker | |
| ⑩ Fastening thread | |
| ⑪ Sliding contacts | |
| ⑫ Microphone connection | |

ADN-W BA Lithium-Ion battery pack

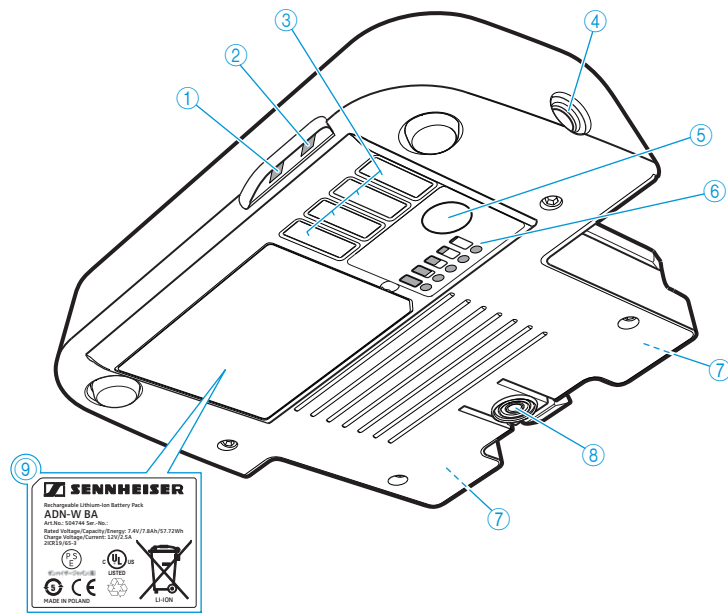

- ① Battery status indicator
- ② RF status indicator
- ③ Charging contacts for ADN-W CASE UNITS charging case
- ④ Hollow jack socket for connection of NT 12-50C power supply
- ⑤ Button for charge status indication
- ⑥ Charge status indicator
- ⑦ Contacts for connection to wireless conference unit and ADN-W L 10 charger
- ⑧ Battery release clip
- ⑨ Type plate

Over view of the status LEDs

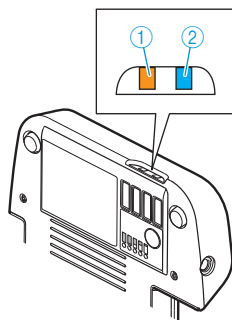

Status-LED	Color	Meaning
Battery status indicator ①	–	Battery capacity 5-100%
	orange, flashing slowly	Battery capacity < 5%, battery pack is almost flat
	orange, flashing rapidly	Battery pack is defective
	orange, lit permanently	Battery pack is being charged
RF status indicator ②	–	Good transmission quality
	blue, flashing slowly	Transmission quality is temporarily reduced
	blue, flashing rapidly	Transmission quality is permanently reduced

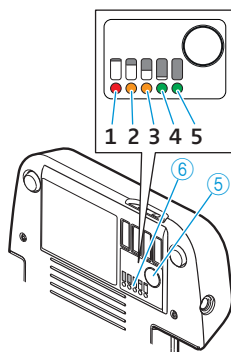

The charge status display ⑥ consists of 5 LEDs and can be called up by pressing the button ⑤. During charging, the LEDs show the obtained capacity.

LED ⑥	Color	Remaining capacity	Remaining operating time
1	red	approx. 0-19%	approx. 0-4 hours
2	orange	approx. 20-39%	approx. 4-8 hours
3	orange	approx. 40-59%	approx. 8-12 hours
4	green	approx. 60-79%	approx. 12-16 hours
5	green	approx. 80-100%	approx. 16-20 hours

ADN-W MIC 15/ADN-W MIC 36 gooseneck microphones for wireless conference units

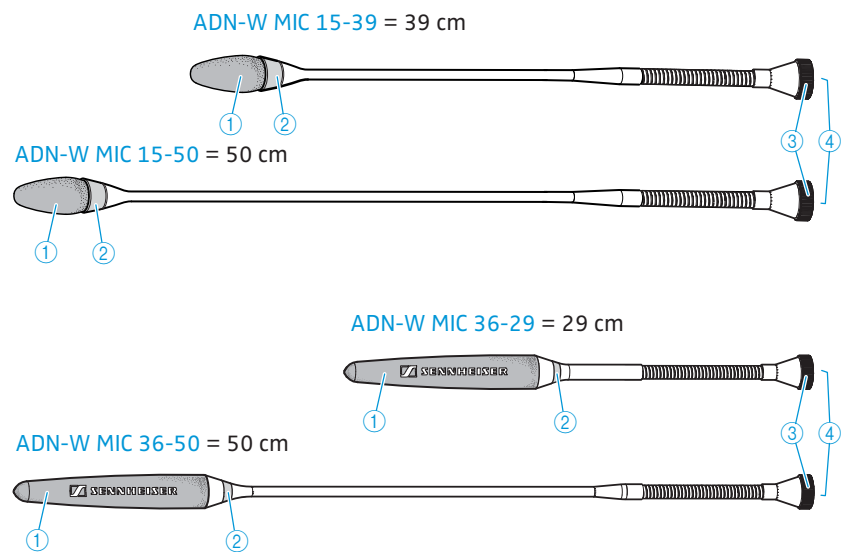

- ① Sound inlet basket with glued windshield
- ② Signal light ring

- ③ Fastening thread
- ④ Sliding contacts for connection to the console of a wireless conference unit

ADN-W AM antenna module

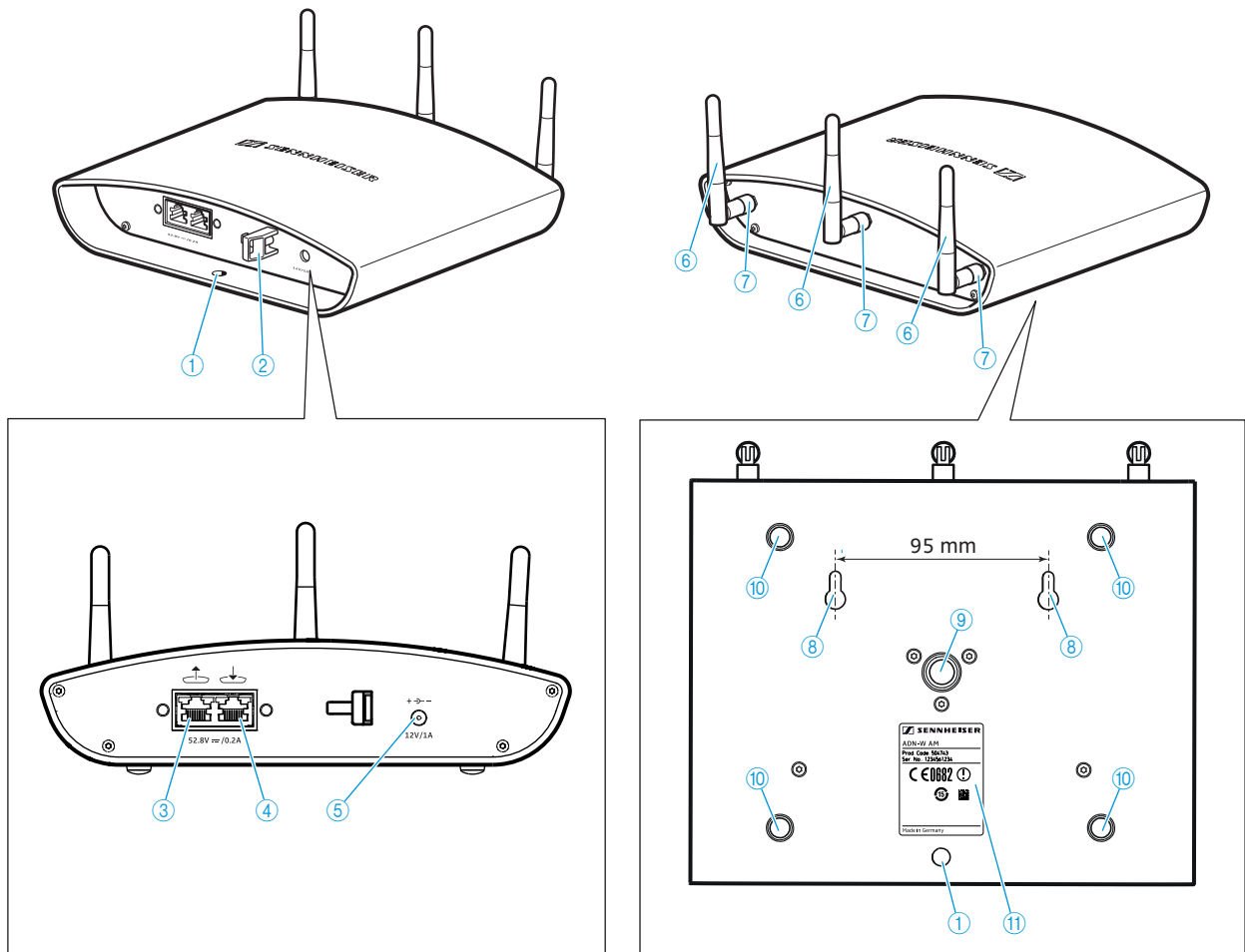

- ① Hole for safety wire
- ② Cable grip
- ③ Output socket
- ④ Input socket
- ⑤ Hollow jack socket for connection of optional NT 12-50C power supply
- ⑥ Antennas
- ⑦ Antenna coupling ring
- ⑧ Mounting holes for wall mounting
- ⑨ 5/8" mounting thread with 3/8" thread insert
- ⑩ Rubber feet
- ⑪ Type plate

NT 12-50C power supply

The power supply can charge one ADN-W BA battery pack or can optionally power the ADN-W AM antenna module.

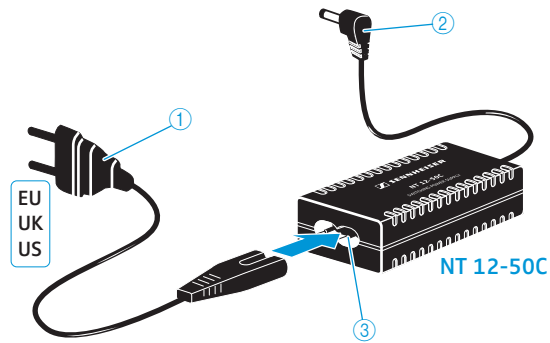

- ① Mains cable with mains plug (with EU, UK or US mains plug, depending on version)
- ② Hollow jack plug
- ③ Euro 8 socket for mains cable

ADN CU1 central unit

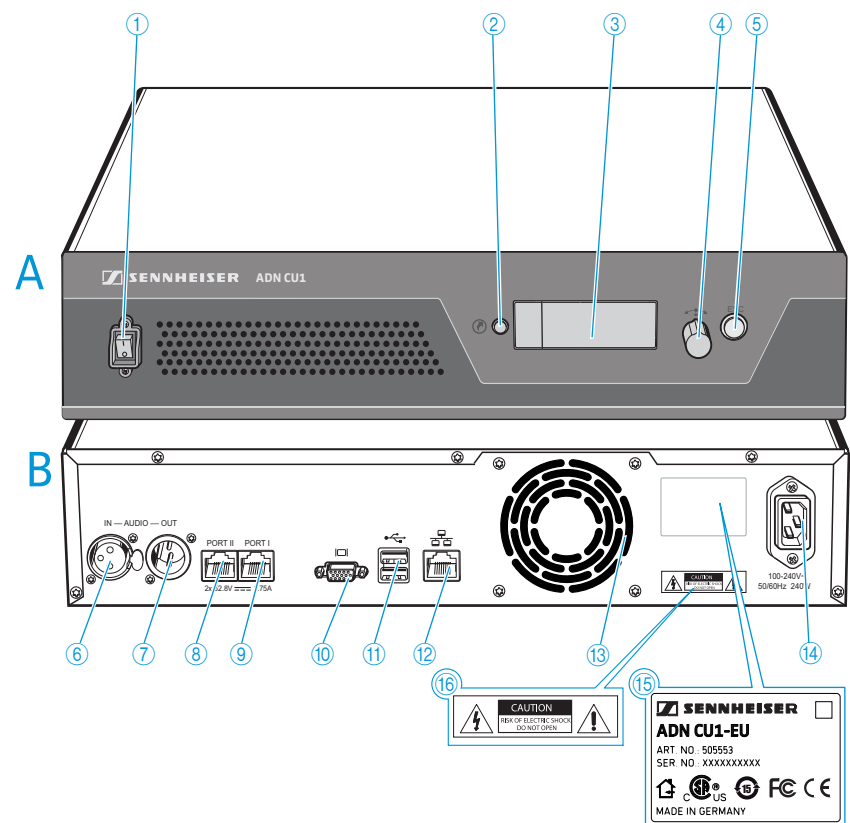

A Front view

- ① On/off switch
- ② Standard display key
- ③ Display
- ④ Jog dial
- ⑤ ESC key (Escape)

B Rear view

- ⑥ IN audio input
- ⑦ OUT audio output
- ⑧ PORT II socket (RJ45) for connection of conference units/ADN PS/ADN-W AM
- ⑨ PORT I socket (RJ45) for connection of conference units/ADN PS/ADN-W AM
- ⑩ VGA monitor output
- ⑪ USB socket (x2)
- ⑫ Network socket (RJ45)
- ⑬ Fans
- ⑭ Mains socket
- ⑮ Type plate
- ⑯ Hazard warnings

Overview of the ADN CU1 display panel

After switch-on, the central unit's display panel shows progress bars (for the booting routine "Booting..." and the self test "Self-Test...") and then the standard display:

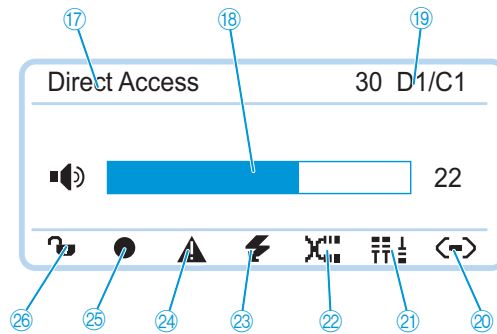

Text/icon	Possible display/function
17 Conference mode	Current conference mode: "Direct Access", "Override", "Push To Talk", "Request"
18 Floor channel volume	Current volume setting for the conference units' built-in loudspeakers
19 Number of conference units	Number of conference units (wired or wireless) connected to the conference system
20 Connection status	< > Central unit is not connected to the "Conference Manager" software and/or a media control unit.
	↔ Central unit is connected to the "Conference Manager" software and/or a media control unit.
21 Structural change icon	Icon appears when, since the last initialization, a malfunction/change has occurred in the cabling of the conference units (see page 102).
22 Cable fault icon	Icon appears when a conference unit is not correctly connected to the ADN CU1 central unit (see page 102).
23 Short-circuit icon	Icon appears when there is a short circuit in the cabling of the conference units (see page 102). The display panel lights up red.
24 Warning triangle	Icon appears when there is a malfunction/change (see page 102). In case of malfunction, the display panel lights up red.
25 Audio recording	Icon appears when audio recording of the conference is activated (see page 122).
	Icon flashes when storage space is low.
	Icon appears when, after finishing the audio recording, data is still written to the mass storage device.
	Icon appears when the audio recording failed. The display panel lights up red.
26 Lock mode icon (see page 83)	Lock mode of the central unit is deactivated.
	Lock mode of the central unit is activated.

“Conference Manager” software



The “Conference Manager” software allows you to configure and control the entire conference from a Windows PC or directly from the ADN CU1 central unit.



Information on the software can be found in the chapter “Using the “Conference Manager” software” on page 125.

ADN PS power supply

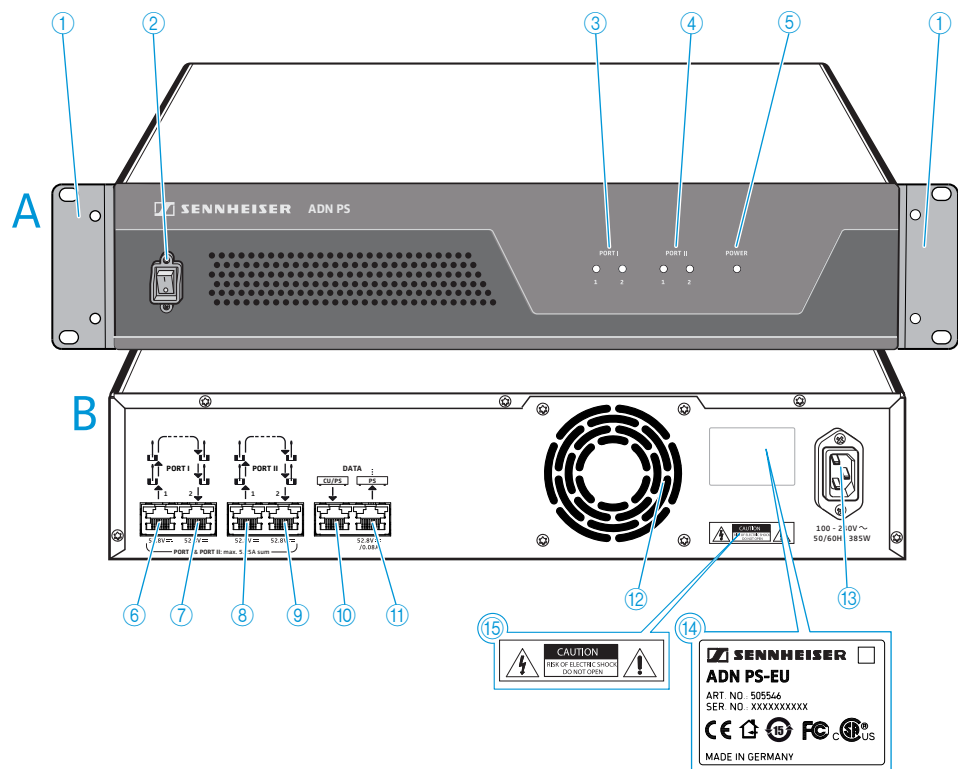

A Front view

- ① Rack mount "ears"
- ② On/off switch
- ③ PORT I status LED for outputs 1 and 2
- ④ PORT II status LED for outputs 1 and 2
- ⑤ POWER status LED

B Rear view

- ⑥ PORT I socket – output 1 (RJ 45) for connection of conference units/ADN-W AM
- ⑦ PORT I socket – output 2 (RJ 45) for connection of conference units/ADN-W AM
- ⑧ PORT II socket – output 1 (RJ 45) for connection of conference units/ADN-W AM
- ⑨ PORT II socket – output 2 (RJ 45) for connection of conference units/ADN-W AM
- ⑩ DATA CU/PS input socket (RJ45) for connection of ADN CU1 central unit or ADN PS power supply
- ⑪ DATA PS output socket (RJ45) for connection of additional ADN PS
- ⑫ Fan
- ⑬ Mains socket
- ⑭ Type plate
- ⑮ Hazard warnings

Overview of the status LEDs

Status LED	Color	Meaning
POWER ⑤	green	ADN PS is switched on
PORT I ③ /Port II ④ output 1/2	–	not used, switched off
	orange	Conference units are connected in strings
	green	Conference units are connected in redundant ring topology via outputs 1 and 2
	flashing orange	Error in a cable string; output is switched off

SDC CBL RJ-45 system cables

The system cables transmit the digital audio and status information and supply power to the conference units and to the antenna module.

Do **not** use unshielded Cat5 cable (26 AWG)!

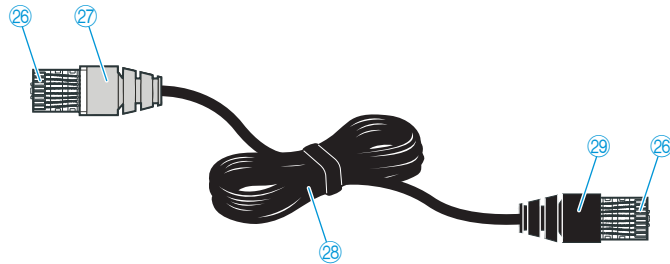

- ②⑥ Shielded RJ 45 modular plug, Cat5(e)
- ②⑦ Gray cable booth with clip protector
- ②⑧ Round STP cable, cat 5(e), 24AWG, black
- ②⑨ Black cable booth with clip protector

ADN-W L 10 charger

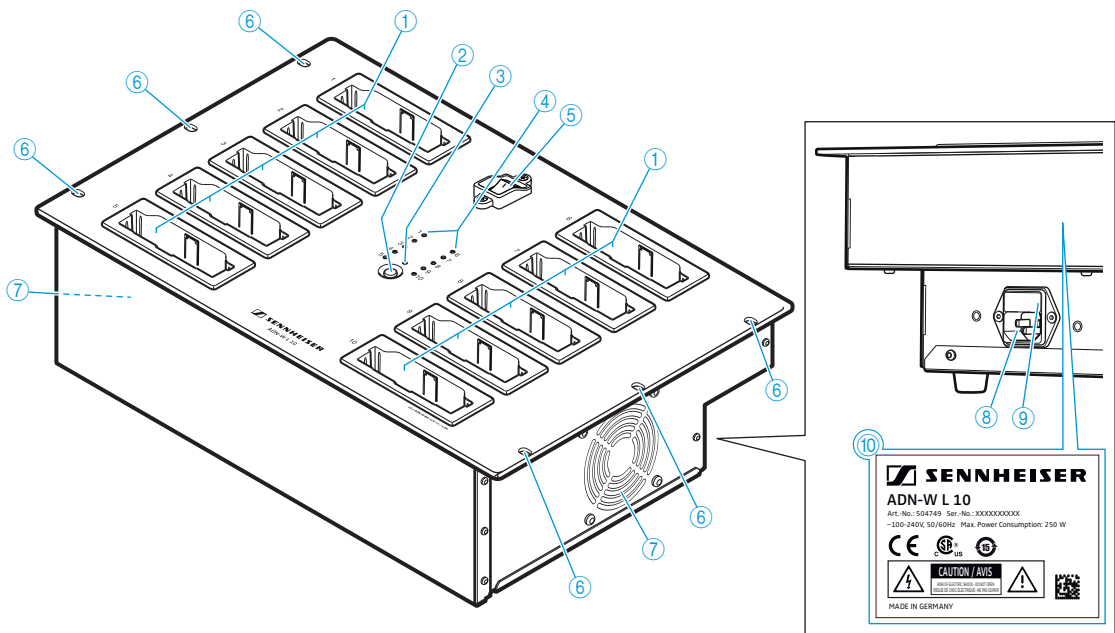

- ① Charging compartments for 10 ADN-W BA battery packs
- ② Button for charge status indication
- ③ Operation indicator, green
- ④ Status display for charging process
- ⑤ On/off switch
- ⑥ Mounting holes for mounting the charger into a 19" rack
- ⑦ Fans
- ⑧ Mains socket
- ⑨ Mains fuse
- ⑩ Type plate and hazard warnings

Overview of the status display of the ADN-W L 10 and ADN-W CASE UNITS

The status display for charging process ④ consists of 10 LEDs. The button ② allows you to switch between two charge status indications to view the obtained capacity:

1. Overall monitoring
2. Individual compartment monitoring (charging compartments 1 to 10 can be selected one after the other)

Overall monitoring

Each LED is assigned to a charging compartment.

LED ④	Color	Capacity obtained
1-10	–	Standby operation; no battery pack inserted or no connection to the mains power supply
	red	approx. 0-19%
	orange	approx. 20-94%
	green	approx. 95-100% Typical charging time is 4 hours with subsequent continuous capacity monitoring
	red, flashing rapidly	Battery pack's temperature is too high
	red, flashing slowly	Battery pack is defective

Individual compartment monitoring

To select the charging compartments 1 to 10 one after the other:

- ▶ Press the button ②.

The LED (1-10) of the selected charging compartment (1-10) lights up green (see diagram as an example for charging compartment 2 ⑪). The adjacent LED strip comprising 5 LEDs displays the charge status in detail (see diagram as an example for a fully charged battery pack ⑫).

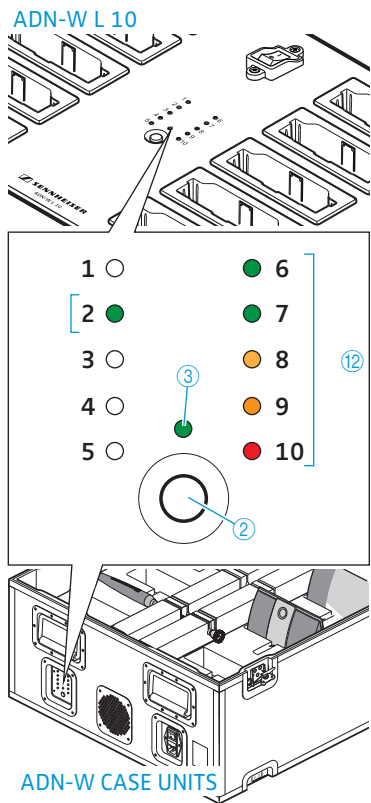

LED ④	Color	Capacity obtained
1 or 6	green	approx. 80-100% Typical charging time is 4 hours with subsequent continuous capacity monitoring
2 or 7	green	approx. 60-79%
3 or 8	orange	approx. 40-59%
4 or 9	orange	approx. 20-39%
5 or 10	red	approx. 0-19%
5 or 10	red, flashing rapidly	Battery pack's temperature is too high
5 or 10	red, flashing slowly	Battery pack is defective

5 seconds after the last button press, the status display switches back from individual compartment monitoring to overall monitoring.

i The labeling of the LEDs is only available on the ADN-W L 10 charger.

ADN-W CASE transport and charging case

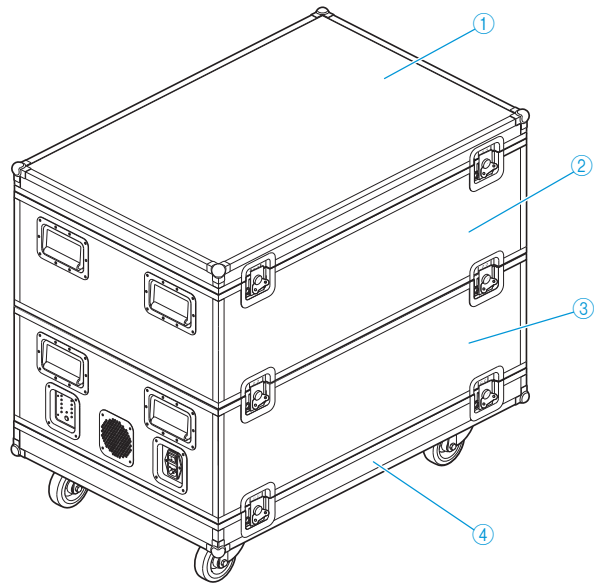

- ① ADN-W CASE BASE case lid
- ② ADN-W CASE CENTRAL transport case for central unit, antenna module, ADN-W L 10 charger, power supplies, mains cables and other accessories
- ③ ADN-W CASE UNITS charging case with charging compartments for 10 wireless conference units
- ④ ADN-W CASE BASE case bottom with wheels



The modules can be used separately or be combined arbitrarily (see page 227).

ADN-W CASE CENTRAL transport case,

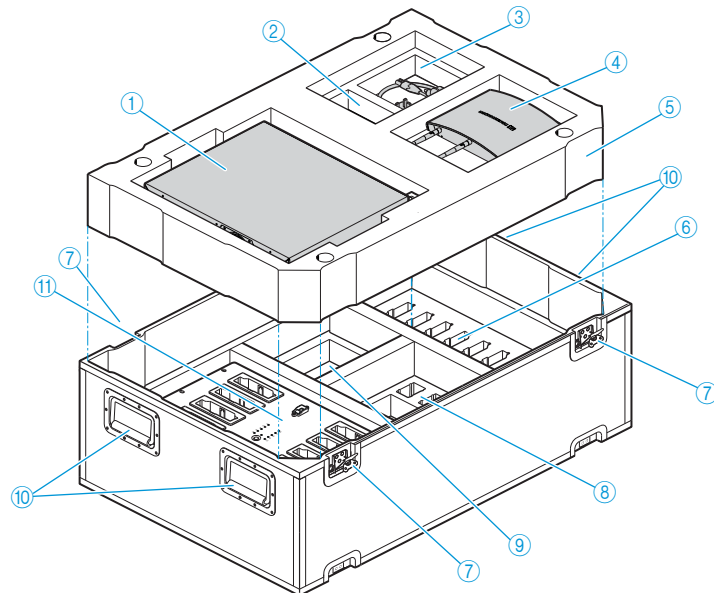

- ① Compartment for ADN CU1 central unit
- ② Compartment for one NT 12-50C power supply
- ③ Compartment for cables and accessories
- ④ Compartment for ADN-W AM antenna module
- ⑤ Intermediate bottom (foam)
- ⑥ Compartments for 10 ADN-W BA battery packs
- ⑦ Butterfly locks
- ⑧ Compartments for 10 NT 12-50C power supplies without mains cables
- ⑨ Compartment for 10 mains cables for NT 12-50C and accessories
- ⑩ Carrying handles, foldable
- ⑪ Compartment for ADN-W L 10 charger

ADN-W CASE UNITS charging case

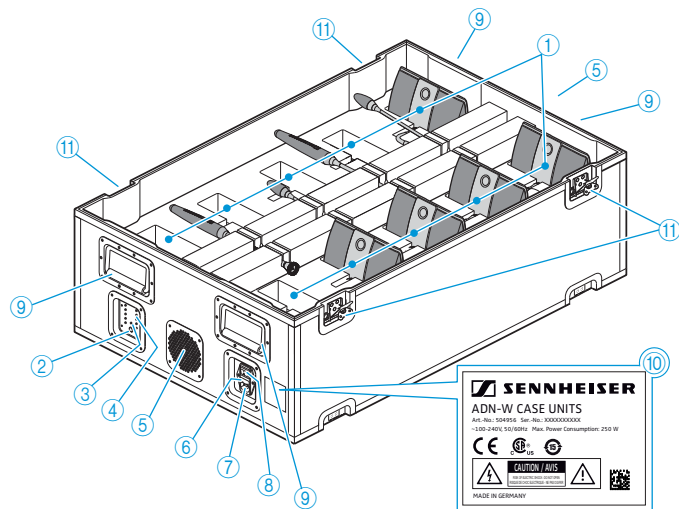

- ① Charging compartments for 10 wireless conference units with their ADN-W BA battery packs
- ② Button for charge status indication
- ③ Operation indicator, green
- ④ Status display for charging process
- ⑤ Fans
- ⑥ Mains fuse
- ⑦ Mains socket
- ⑧ On/off switch
- ⑨ Carrying handles, foldable
- ⑩ Type plate and hazard warnings
- ⑪ Butterfly locks

Overview of the status LEDs

The status display for charging process is identical with the status display of the ADN-W L 10 charger (see page 25).

ADN-W CASE BASE

Case lid

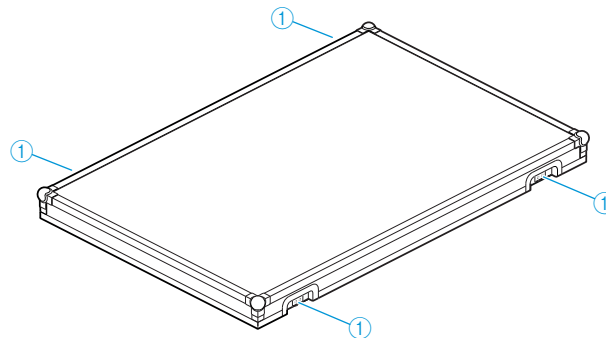

Case bottom

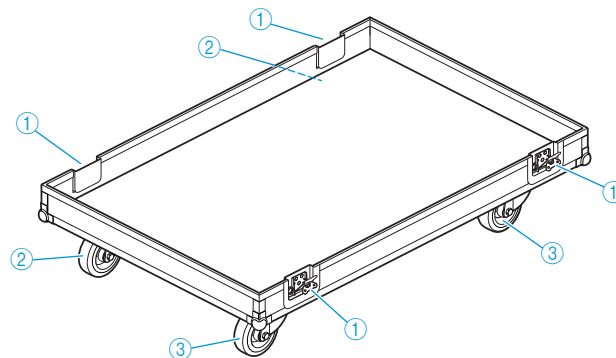

- ① Butterfly locks
- ② Wheels
- ③ Lockable casters

Structuring and controlling the conference system

The ADN conference system is suitable for conferences with up to 400 conference units (of which up to 150 can be wireless). ADN C1 and ADN D1 wired conference units and ADN-W C1 and ADN-W D1 wireless conference units can be combined arbitrarily as long as you ensure correct set-up and cabling and comply with the specifications (see “Setting up the conference system” on page 56).

Number of chairperson and delegate units

There are two types of conference units available for the ADN conference system:

- **Delegate units** for listening to the floor channel and for making contributions to the conference
- **Chairperson units** for listening to the floor channel, for making contributions to the conference and for managing the conference

The number of conference units is limited to a total of 400 (of which up to 150 can be wireless). Due to the fact that a chairperson unit allows you to take the floor at any time without having to “apply” for a comment, you can only use a maximum of 10 chairperson units in a conference system. In this case, however, the delegate units can only be used for listening to the floor channel because all 10 channels are already reserved for contributions coming from the chairperson units.

Recommendation: Use only a maximum of 9 chairperson units in a conference system in order to have one channel available for contributions coming from delegate units.

Calculating the voltage supply of the wired conference units and system components

The “[ADN Cable Calculator](#)” software allows you to calculate the voltage supply of the wired conference units on the individual sections of a cable string or cable ring and to plan the structure of the conference system. The software is included on the DVD-ROM (supplied with the ADN CU1) or is available from your Sennheiser partner or from the “Downloads” area on the product page at www.sennheiser.com.

For further information on the installation and use of the “[ADN Cable Calculator](#)” software, refer to page 35.

Setting up a wired conference system

Basic requirements for a conference system comprising wired conference units

For safe operation of the conference system, make sure that all wired conference units are supplied with a voltage of at least 35 V! The voltage supplied depends on the number of connected conference units and on the cable lengths. The standard cable length between the central unit or power supply and the first conference unit is 50 m max. and the standard cable length between the individual conference units is 2 to 5 m.

If these cable lengths are observed, safe operation of conference systems with the following number of conference units is ensured:

- small conference systems comprising only an ADN CU1 central unit
 - 30-40 conference units connected in simple strings
- large conference systems comprising an ADN CU1 central unit and a max. of 15 ADN PS power supplies
 - max. 400 conference units connected in simple strings or in ring topology per ADN PS power supply
 - 60-70 conference units connected in simple strings
 - 30-40 conference units connected in ring topology

If cable lengths are shorter, it might be that more conference units can be used.

ADN D1 delegate units and ADN C1 chairperson units can be combined in an arbitrary order. The number of chairperson units, however, is limited to 10 max. per conference system. All wired components of the conference system are interconnected using SDC CBL RJ-45 system cables.

Small conference system with simple cabling

For small conference systems with approx. 30-40 conference units, you require one ADN CU1 central unit for controlling the conference. The conference units are interconnected in two cable strings which are directly connected to the central unit (see page 57).

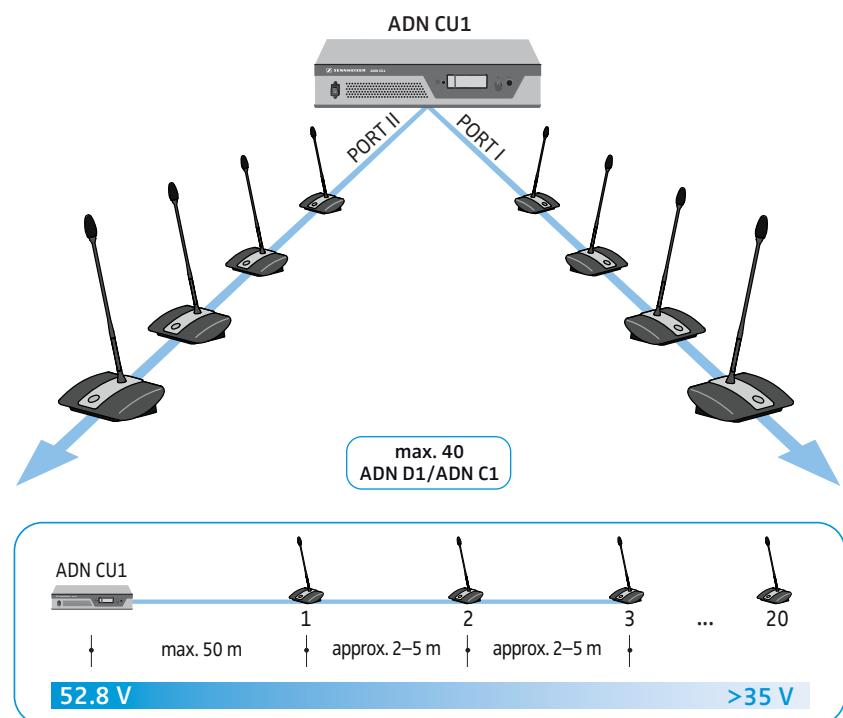

Large conference system with simple cabling

For setting up a large conference system with the maximum number of conference units (i.e. up to 400), you require one ADN CU1 central unit for controlling the conference and additional ADN PS power supplies for powering the conference units. The conference units are interconnected in cable strings and up to four cable strings can be connected to each ADN PS power supply (see page 58).

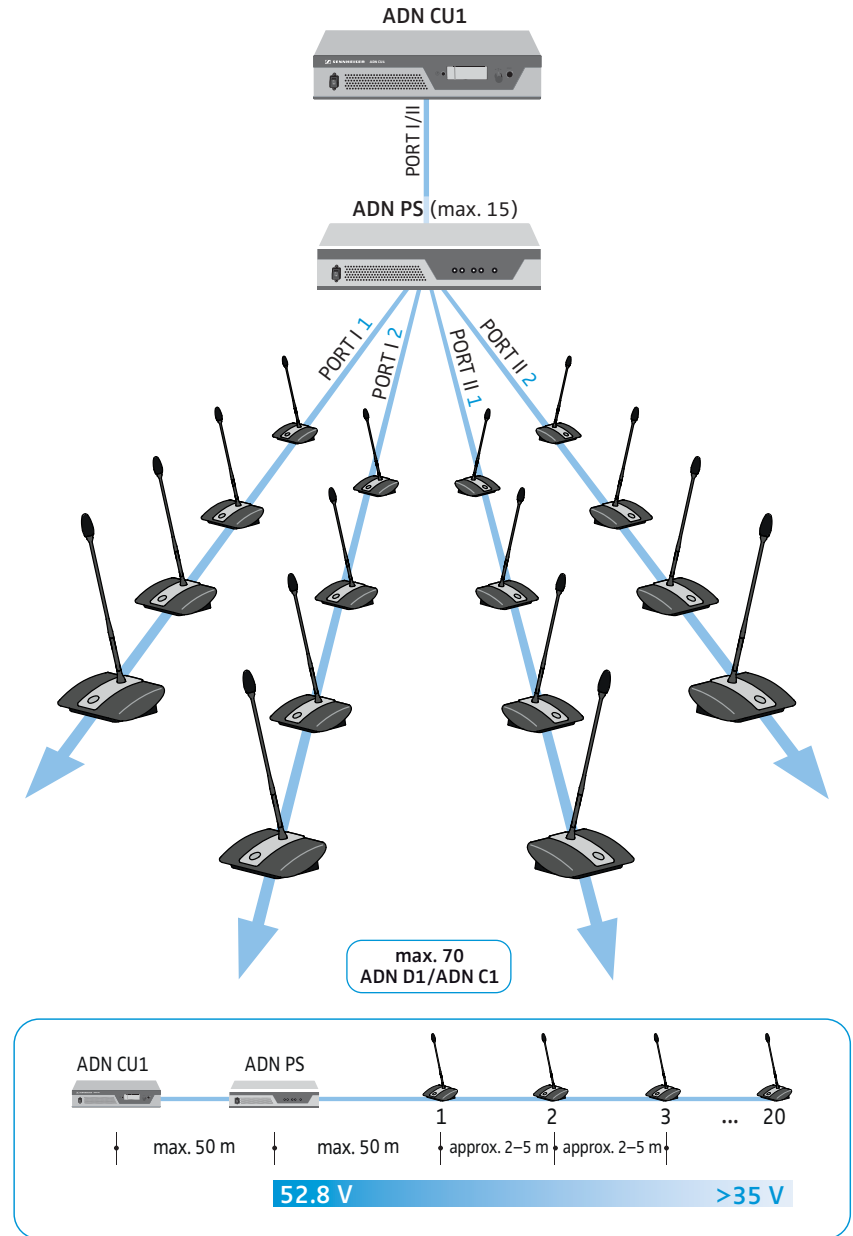

Large conference system with redundant ring topology

The redundant ring topology ensures that, should one conference unit or system cable fail or be manipulated, all other conference units of the cable ring will continue to function reliably.

For setting up a large conference system with redundant ring topology, you require one ADN CU1 central unit for controlling the conference and additional ADN PS power supplies for powering the conference units. The conference units are interconnected in rings and two rings can be connected to each ADN PS power supply (see page 60).

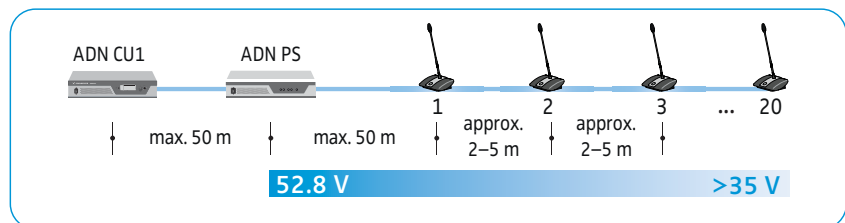
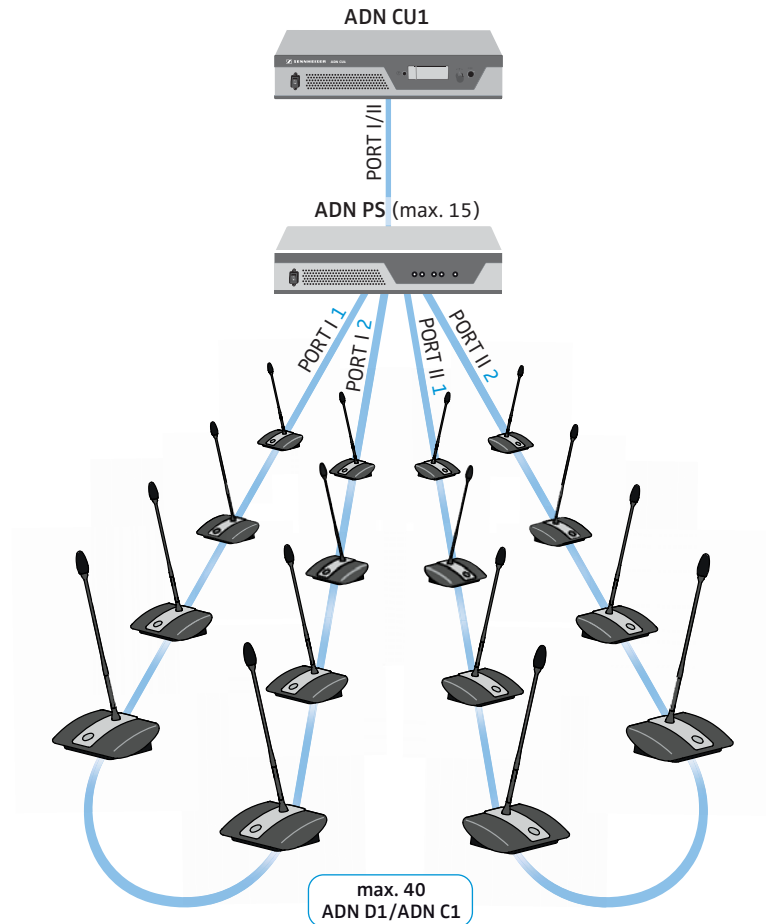

When connecting the conference units to an ADN PS power supply, you can mix different cable topologies (simple cabling with cable strings or redundant ring topology) as long as you ensure correct cabling and comply with the specifications (see page 58 and page 60).

Combining wired and wireless conference units (hybrid operation)

ADN C1 and ADN D1 wired conference units and ADN-W C1 and ADN-W D1 wireless conference units can be combined arbitrarily (hybrid operation) as long as you ensure correct set-up and cabling and comply with the specifications (see page 56).

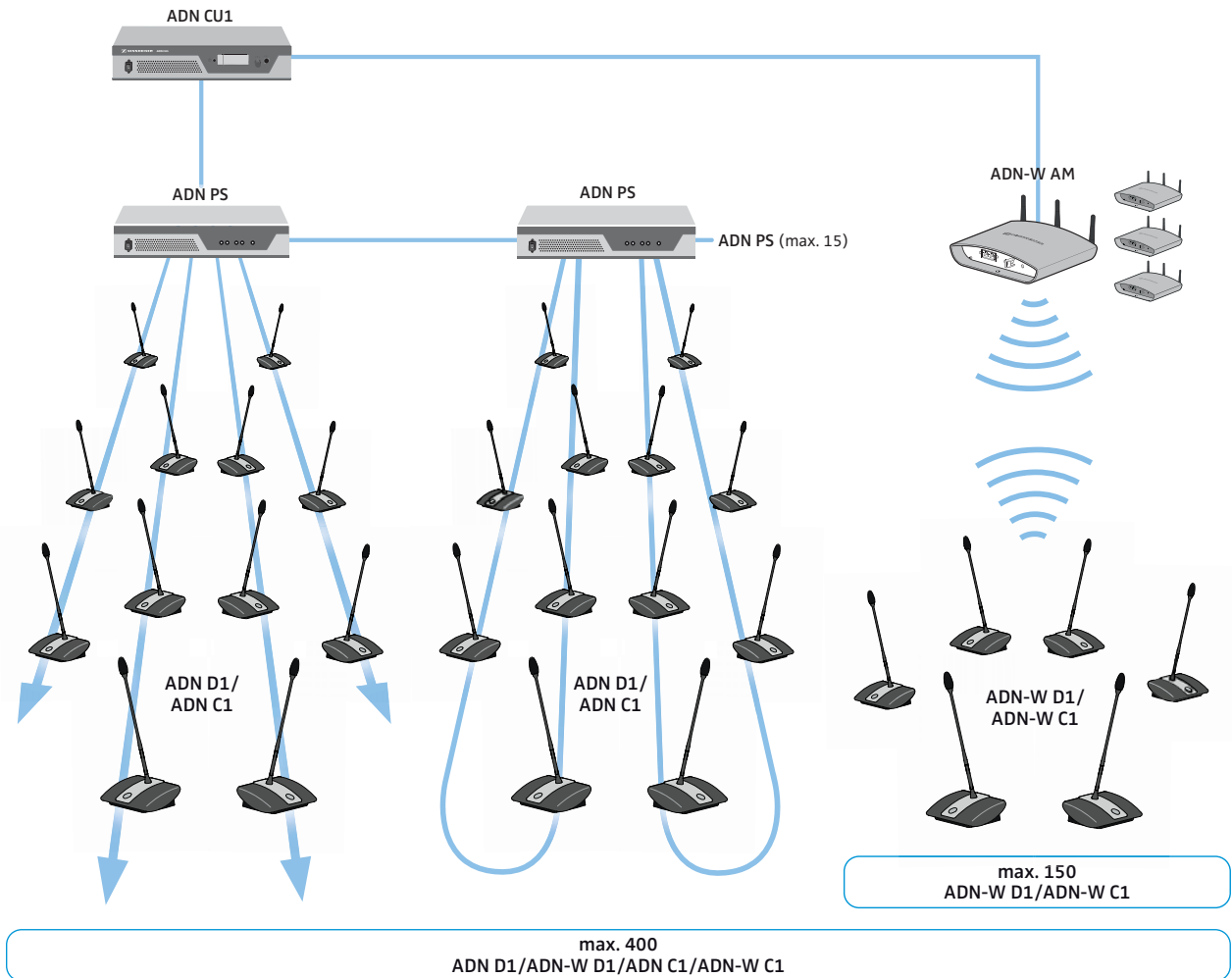

Configuring and controlling the conference system

For configuring the conference system, you can either use the operating menu of the central unit or the “Conference Manager” software. However, the full functionality of a wireless conference system can only be configured using the “Conference Manager” software. The software also allows you to control conferences via a graphical interface:

Function	Operating menu	“Conference Manager” software
Configuring the conference	✓	✓
Configuring the wireless conference components	possible with restrictions*	✓
Controlling the conference via a graphical interface	✗	✓
Monitoring the wireless conference components	✗	✓

* When using the operating menu, you can only select dynamic frequency management and the wireless conference units can only automatically connect to the antenna module (“Access Mode - Open”). Manual frequency selection and manual log-in of the conference units (“Access Mode - Closed”) are only possible using the “Conference Manager” software.

The “Conference Manager” software can be run in two different ways:

1. As a program on the central unit’s built-in PC
You have to connect a screen, keyboard, and mouse to the central unit (see page 126).
2. As a program on a Windows PC
You have to install the “Conference Manager” software on the PC and integrate the PC together with the central unit in a network (see page 127).

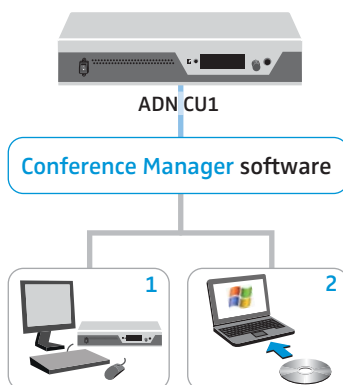

Input and output of audio signals

Via XLR sockets, you can feed audio signals to the floor channel or output the floor channel (see page 75).

For recording a conference on a USB mass storage device, you can use the recording function of the ADN CU1 central unit, which saves the floor channel and all channels of the conference units as audio files in wav format (see page 122).

Integration into a media control system

The ADN conference system can be completely integrated into a media control system. You can monitor and control all functions of the conference system via the programmable commands of your media control system (see page 80).

Using the ADN Cable Calculator software

The “ADN Cable Calculator” software allows you to calculate the voltage supply on the individual sections of a cable string or cable ring. If you want to use wireless conference units in your conference system, you also have to calculate the voltage needed to power the ADN-W AM antenna module in order to ensure that all components are supplied with sufficient voltage. If no warnings are given after the calculation and you set up your conference system as calculated with the software, your conference system will run within the specifications.

 The “ADN Cable Calculator” software is only available in English.

System requirements

Component	Requirement
PC	Standard PC with x86-CPU
Operating system	Microsoft Windows XP Microsoft Windows Vista Microsoft Windows 7 Microsoft Windows 8

Installing the ADN Cable Calculator

 The following steps describe the installation of the “ADN Cable Calculator” software on a PC running Windows 8. The installation on a PC running Windows XP, Windows Vista or Windows 7 is performed in a similar way.

To install the software, you require administrator rights.

- ▶ Close all running applications.
- ▶ Start the “ADNCableCalcSetup.exe” file in the “ADN Cable Calculator” folder on the enclosed DVD-ROM.
After you have accepted the license agreement, a confirmation prompt appears:

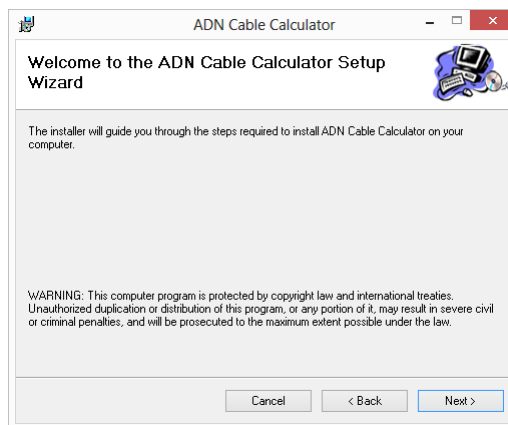

- ▶ Click the “Next” button.
A selection window for specifying the installation location appears:

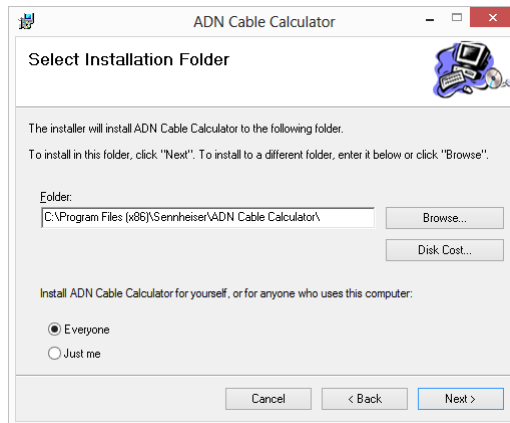

- ▶ Use the default or select an installation path.
- ▶ Click the “Next” button.
A summary of the selected installation settings is displayed:

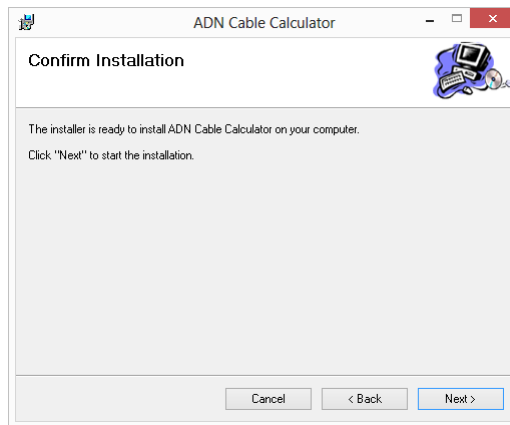

- ▶ Confirm this summary by clicking the “Next” button.
The installation is performed and a confirmation appears:

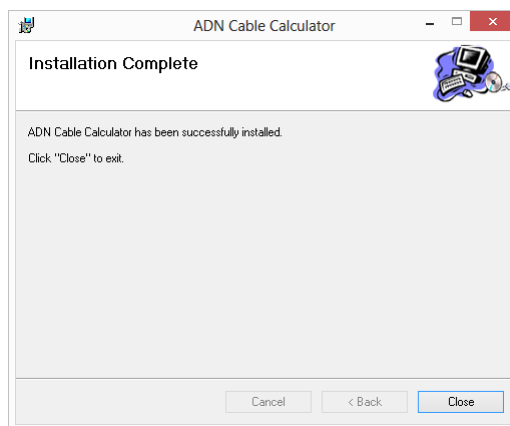

- ▶ Click the “Close” button.
The software has been successfully installed.

Using the ADN Cable Calculator

To use the “ADN Cable Calculator” software and to calculate the cable lengths and number of conference units:

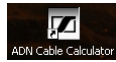

- ▶ Start the “ADN Cable Calculator” software from the Start menu or the shortcut on your desktop.

For further information and for how to calculate the voltage drops on the individual sections of a cable string, refer to the help of the “ADN Cable Calculator” software.

- ▶ In the menu bar, click “Help” > “Help ...” or press the F1 key on the keyboard.

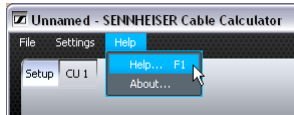

Uninstalling the ADN Cable Calculator

You can uninstall the “ADN Cable Calculator” software using the installation wizard on the DVD-ROM or using the Windows Control Panel (category “Add or Remove Programs”, entry “ADN Cable Calculator”).

If you use the installation wizard to uninstall the software, the wizard automatically starts in repair mode:

- ▶ Start the “ADNCableCalcSetup.exe” file in the “ADN Cable Calculator” folder on the enclosed DVD-ROM.
- ▶ Select “Remove ADN Cable Calculator”.

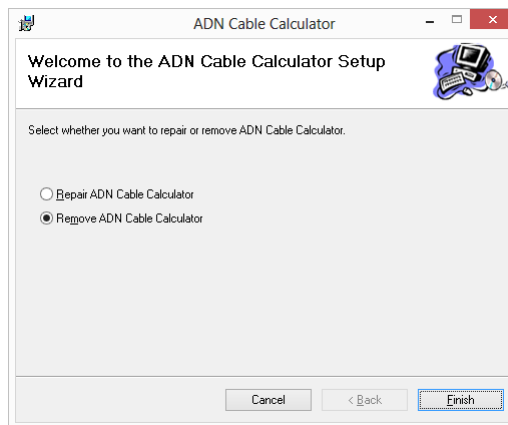

- ▶ Click the “Finish” button.
The software is uninstalled.

Putting the conference system into operation

Preparing the ADN CU1 central unit for operation

Setting up the central unit on a flat surface or mounting it into a rack

If you want to place the central unit [on a flat surface](#):

- ▶ Make sure that the air vents are not covered or blocked.
- ▶ Place the central unit on a flat surface as shown.

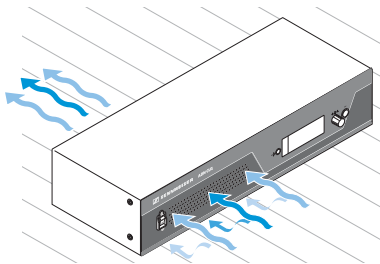

If you want to mount the central unit [into a 19" rack](#), the central unit must be supported and fixed to the rack using additional components.



CAUTION

Danger of material damage and personal injury when rack mounting the central unit!

When installing the product in a closed or multi-rack assembly, please consider that, during operation,

- the ambient temperature within the rack may drastically increase,
- high mechanical loading may be exerted on e.g. the housings or cables,
- intrinsically harmless leakage currents of the individual mains units may accumulate, thereby exceeding the allowable limit value.

This can cause material damage and electric shocks.

- ▶ **Always** mount the central unit using a suitable rack tray. Make sure that the mechanical loading of the rack is even.
- ▶ Make sure that the ambient temperature within the rack does not exceed the permissible temperature limit specified in the specifications (see page 240). Ensure sufficient ventilation; if necessary, provide additional ventilation.
- ▶ Provide for a duct or vent space of 1 U above the ADN CU1 central unit to ensure that the heated air can dissipate.
- ▶ When connecting to the mains power supply, observe the information indicated on the type plate. Avoid circuit overloading. If necessary, provide overcurrent protection.
- ▶ Ground the rack via an additional ground connection.

Fastening the optional rack mount "ears"

- ▶ Unscrew and remove the 2 torx screws (T25) on each side of the central unit (see left-hand diagram).
- ▶ Secure the optional ADN RMB-2 rack mount "ears" ③① (see "Components and accessories" on page 237) the sides of the central unit using the previously removed torx screws (see right-hand diagram).

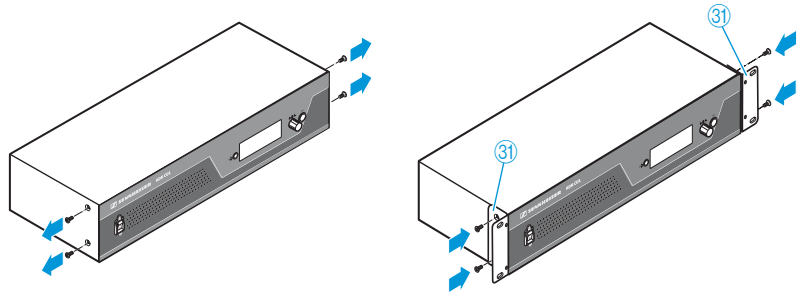

- ▶ Slide the central unit with the mounted rack mount "ears" into the 19" rack and support the weight with e.g. a rack tray.
- ▶ Secure the rack mount "ears" to the rack.

i An engineering drawing detailing the dimensions of the central unit can be found in the appendix (see page 248).

Connecting the central unit to the mains power supply

CAUTION

Product damage due to unsuitable mains cables or power outlets!

An unsuitable power supply can damage the product.

- ▶ Use the mains cable (supplied) for connecting the product to the mains power supply.
 - ▶ Only use multi-outlet power strips or extension cables with protective ground contacts.
 - ▶ Only use mains cables with a 3-pin connector.
-
- ▶ First connect the connector of the mains cable (supplied) to the mains socket ⑭.
 - ▶ Connect the mains plug of the mains cable to a wall socket.
The ADN CU1 central unit is now ready for operation.

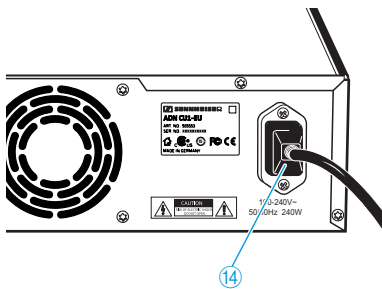

Preparing the ADN PS power supply for operation

If you want to place the ADN PS power supply on a flat surface:



CAUTION

Danger of material damage and personal injury due to stacked power supplies!

When stacking several ADN PS power supplies on top of each other,

- the stack may topple over,
- the temperature of the individual ADN PS power supplies may drastically increase,
- high mechanical loading may be exerted on e.g. the housings, cables or installation surfaces.

This can cause material damage and personal injury.

- ▶ Never stack several ADN PS power supplies on top of each other.

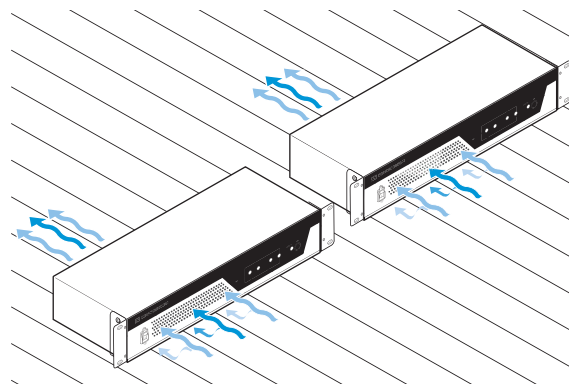

- ▶ Make sure that the air vents are not covered or blocked.
- ▶ Place the ADN PS power supply on a flat surface as shown.

If you want to mount the ADN PS power supply into a 19" rack:



CAUTION

Danger of material damage and personal injury when rack mounting the power supply!

When installing the product in a closed or multi-rack assembly, please consider that, during operation,

- the ambient temperature within the rack may drastically increase,
- high mechanical loading may be exerted on e.g. the housings or cables,
- intrinsically harmless leakage currents of the individual mains units may accumulate, thereby exceeding the allowable limit value.

This can cause material damage and electric shocks.

- ▶ Make sure that the mechanical loading of the rack is even.
- ▶ Make sure that the ambient temperature within the rack does not exceed the permissible temperature limit specified in the specifications (see page 240). Ensure sufficient ventilation; if necessary, provide additional ventilation.
- ▶ Provide for a duct or vent space of 1 U above the ADN PS power supply to ensure that the heated air can dissipate.
- ▶ When connecting to the mains power supply, observe the information indicated on the type plate. Avoid circuit overloading. If necessary, provide overcurrent protection.
- ▶ Ground the rack via an additional ground connection.

- ▶ Slide the ADN PS power supply into the 19" rack.
- ▶ Secure the rack mount "ears" to the rack.



An engineering drawing detailing the dimensions of the ADN PS power supply can be found in the appendix (see page 249).

Connecting the ADN PS power supply to the mains power supply

CAUTION

Product damage due to unsuitable mains cables or power outlets!

An unsuitable power supply can damage the product.

- ▶ Use the mains cable (supplied) for connecting the product to the mains power supply.
- ▶ Only use multi-outlet power strips or extension cables with protective ground contacts.
- ▶ Only use mains cables with a 3-pin connector.

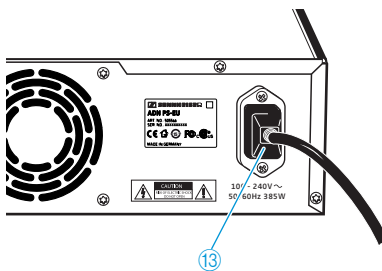

- ▶ First connect the connector of the mains cable (supplied) to the mains socket 13.
- ▶ Connect the mains plug of the mains cable to a wall socket. The ADN PS power supply is now ready for operation.

Preparing the ADN-W AM antenna module for operation

The antenna module is powered from the ADN CU1 central unit or the ADN PS power supply via the SBC CBL RJ45 system cable.

i If the power supplied via the system cable is not sufficient and if the antenna module is not listed in the central unit's operating menu under "System Menu" > "Versions" > "Hardware Version Info" or "Software Version Info":

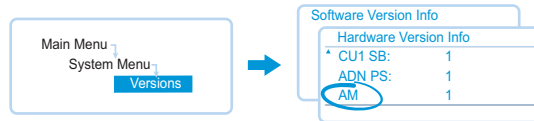

- ▶ Use the optional NT 12-50C power supply.

Connecting the antennas

Always use all 3 antennas to ensure reliable wireless operation. The 3 antennas are already connected upon delivery.

CAUTION

Radio communication outside the legal requirements!

When connecting antennas other than the supplied ones, the transmission power of the conference system may not meet the legal requirements and may cause interference to other radio equipment.

- ▶ Only connect the supplied rod antennas to the antenna module.

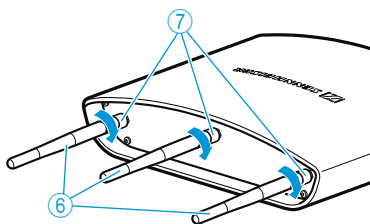

- ▶ Connect the 3 antennas ⑥ to the 3 antenna sockets.
- ▶ Screw down the 3 antenna coupling rings ⑦ as shown. The antennas are connected and secured.

Connecting the ADN-W AM antenna module to the mains power supply

Using the “ADN Cable Calculator” software, calculate if you require an additional power supply for the antenna module (see page 35). If the power supplied to the antenna module via the SBC CBL RJ45 system cable is not sufficient, you have to power the antenna module using the optional NT 12-50C power supply.

CAUTION

Product damage due to an unsuitable power supply!

If you use an unsuitable power supply, this can cause damage to the ADN-W AM antenna module.

▶ Only connect the NT 12-50C power supply to the ADN-W AM antenna mount.

▶ Connect the hollow jack plug ② the NT 12-50C power supply to the hollow jack socket ⑤.

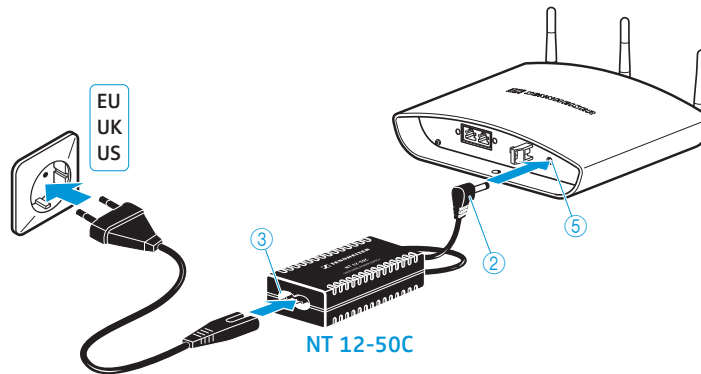

- ▶ Pass the cable through the cable grip ② as shown on the left.
- ▶ Connect the Euro 8 connector of the mains cable to the socket ③ of the NT 12-50C power supply.
- ▶ Connect the mains plug of the mains cable to a wall socket.

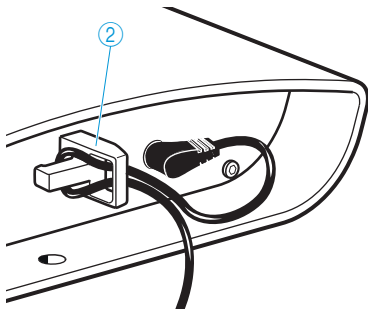

Preparing the ADN C1/ADN D1 wired conference units for operation

The conference units are ready for operation upon delivery. The conference system automatically recognizes if the connected conference units are chairperson units (ADN C1) or delegate units (ADN D1) and initializes them automatically.

i To ensure full operational reliability in a redundant ring topology, the hardware of the ADN C1 and ADN D1 has been revised. If you combine conference units with hardware revision 1 (no marking on the type plate) and conference units with hardware revision 2 ("HW: v2" is printed on the type plate), fail-safe operation is only possible to a limited extent (see also page 111).

- ▶ In a redundant ring topology, only use conference units with hardware revision 2.

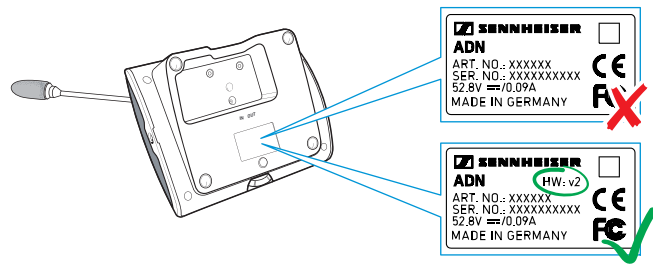

i If you connect chairperson units to the conference system during a running conference, you have to re-initialize them (see page 94 or page 191).

Installing the cable holder

If you want to permanently install your conference system in a room, use the optional cable holders (see "Components and accessories" on page 237).

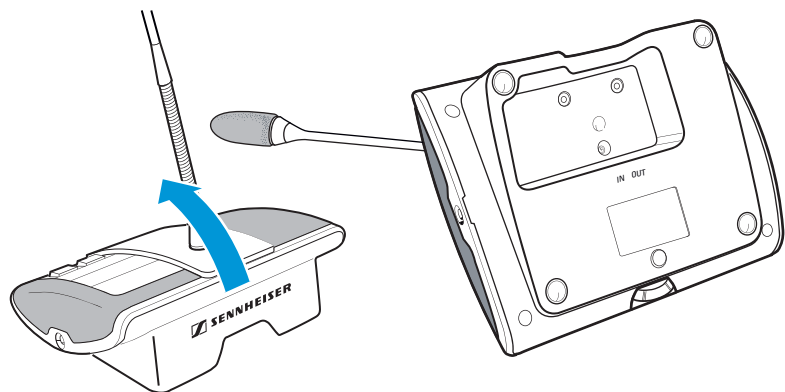

- ▶ Tilt the conference units as shown.

- ▶ Hold the conference units with one hand so that the microphone does not rest on the table.

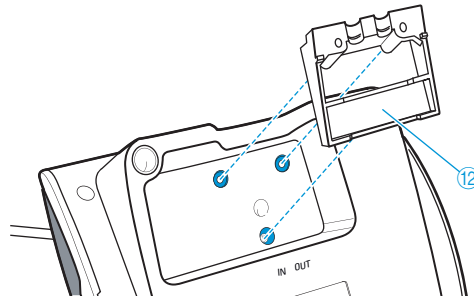

- ▶ Insert the cable holder 12 as shown. At this point, the cable holder 12 is **not yet** fixed with screws. You first have to connect the conference units as described in the chapter "Setting up the conference system" on page 56.

After you have correctly connected and installed all conference units:

- ▶ Choose a suitable cover 13 for the cable holder 12:

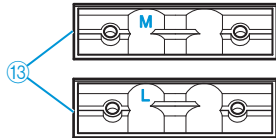

Cable	Cable holder cover
SDC CBL RJ 45 system cable	marked "M"
Highly shielded cable	marked "L"

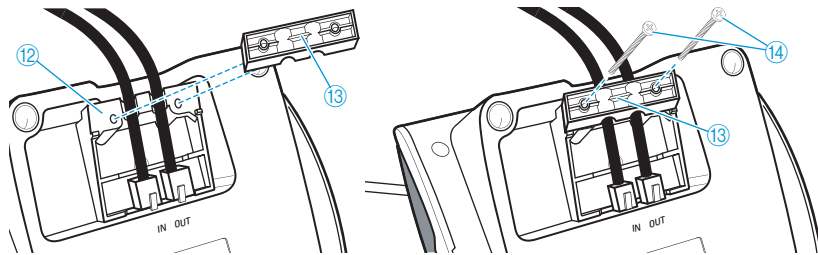

- ▶ Affix the covers 13 as shown.
- ▶ Slightly tighten the supplied screws 14 (approx. 0.05 Nm).

Preparing the ADN-W C1/D1 wireless conference units for operation

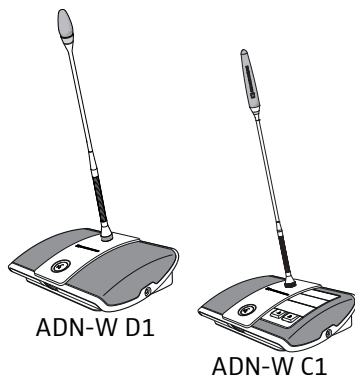

To operate the wireless conference unit, you have to connect a gooseneck microphone (ADN-W MIC 15 or ADN-W MIC 36; available in different lengths) to the console of the conference unit. The ADN-W BA battery pack supplies power to the wireless conference unit. The conference system automatically recognizes if the connected wireless conference unit is a chairperson unit (ADN-W C1) or a delegate unit (ADN-W D1) and initializes it automatically.

i If you do not connect a microphone to the wireless conference unit, you can use the console as a loudspeaker to output the floor channel.

Screwing on/unscrewing the ADN-W MIC 15/36 gooseneck microphone

To **screw on** the gooseneck microphone:

- ▶ Put the gooseneck microphone onto the microphone connection ⑫.

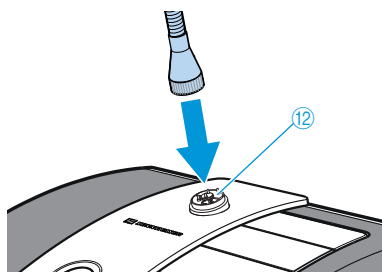

- ▶ Screw the microphone to the microphone connection by turning the fastening thread ⑩ clockwise. The microphone is securely connected to the conference unit.

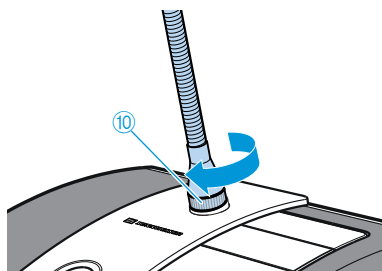

To **unscrew** the gooseneck microphone:

- ▶ Unscrew the microphone by turning the fastening thread ⑩, counterclockwise.
- ▶ Carefully remove the gooseneck microphone from the microphone connection.

Function check of the microphone

After switch-on (see page 78), the wireless conference unit checks the proper functioning of the gooseneck microphone.

If errors occur during the check of the microphone, the microphone LED ⑧ and, if the microphone is power supplied, the signal light ring ② flash red rapidly and the microphone is automatically deactivated.

- ▶ Replace the defective microphone by a new one.

If you screw the microphone to or unscrew it from the wireless conference unit during operation (wireless conference unit is switched on), proper functioning of the conference unit cannot be guaranteed, i.e. volume differences or noise may occur.

- ▶ First connect the microphone and then switch on the conference unit.

Inserting/removing the battery pack

To **insert** the ADN-W BA battery pack into the wireless conference unit:

- ▶ Check the battery pack before using it in order to ensure sufficient battery capacity and to exclude a defective battery pack (see page 51).
- ▶ Charge the battery pack if necessary (see page 51).
- ▶ Slide the battery pack into the battery guide rails ⑬ of the wireless conference unit.

The battery release clip ⑧ locks into place with an audible click and secures the battery pack.

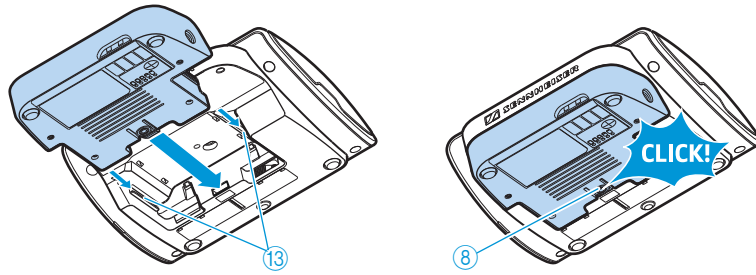

To **remove** the battery pack from the wireless conference unit:

- ▶ Press the battery release clip ⑧ and pull the battery pack out of the battery guide rails.

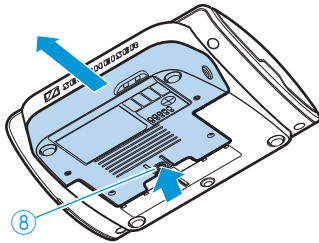

Preparing the ADN-W L 10 charger for operation

The ADN-W L 10 charger allows you to simultaneously charge up to 10 ADN-W BA Lithium-Ion battery packs. You can set up the charger on a flat surface or mount it into a 19" rack (7 U, approx. 310 mm).

Setting up the charger or mounting it into a rack

- ▶ Only operate the charger within the specified operating temperature range and air humidity range (see page 246) and make sure that no air vents ⑦ are blocked.
- ▶ Place the charger on a flat, horizontal surface as shown.

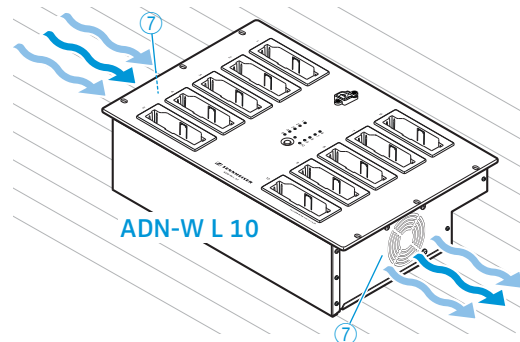

If you want to mount the ADN-W L 10 charger into a 19" rack:



CAUTION

Danger of material damage and personal injury when rack mounting the charger!

When installing the product in a closed or multi-rack assembly, please consider that, during operation,

- the ambient temperature within the rack may drastically increase,
- high mechanical loading may be exerted on e.g. the housings or cables,
- intrinsically harmless leakage currents of the individual mains units may accumulate, thereby exceeding the allowable limit value.

This can cause material damage and electric shocks.

- ▶ Make sure that the mechanical loading of the rack is even.
- ▶ Make sure that the ambient temperature within the rack does not exceed the permissible temperature limit specified in the specifications (see page 246). Ensure sufficient ventilation; if necessary, provide additional ventilation.
- ▶ When connecting to the mains power supply, observe the information indicated on the type plate. Avoid circuit overloading. If necessary, provide overcurrent protection.
- ▶ Ground the rack via an additional ground connection.

- ▶ Slide the ADN-W L 10 charger into a 19" rack.
- ▶ Fasten the charger to the rack by screwing 6 screws (cross recessed head screws M6x12, to be ordered separately) through the 6 mounting holes ⑥.



An engineering drawing detailing the dimensions of the ADN-W L 10 charger can be found in the appendix (see page 250).

Connecting the charger to and disconnecting it from the mains power supply

CAUTION

Product damage due to an unsuitable power supply!

If you connect the charger to an unsuitable power supply, this can cause damage to the device.

- ▶ Use a mains cable with a 3-pin IEC mains connector to ensure a reliable mains ground connection of the charger – especially when you are using an extension cable or a multi-outlet power strip.
 - ▶ Avoid circuit overloading. If necessary, provide overcurrent protection.
-

To connect the charger to the mains power supply:

- ▶ Connect the connector of the mains cable to the mains socket ⑧.
- ▶ Connect the mains plug (EU, UK or US plug) of the mains cable to the wall socket. Ensure a secure fit of the mains plug in the wall socket. The charger is now ready for operation.

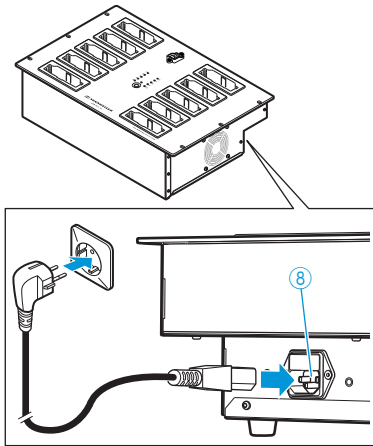

To disconnect the charger from the mains power supply:

- ▶ Pull out the mains plug from the wall socket.

Preparing the ADN-W CASE UNITS charging case for operation

The ADN-W CASE UNITS charging case allows you to simultaneously charge up to 10 ADN-W C1 or ADN-W D1 wireless conference units with their ADN-W BA battery packs installed.

Setting up the charging case

CAUTION

Danger of heat accumulation in a closed charging case!

The ADN-W CASE UNITS charging case and the ADN-W BA battery packs can get hot during charging. If the heat cannot dissipate, the charging time increases and the products can be damaged.

- ▶ Only operate the charging case in closed rooms and within the specified operating temperature range and air humidity range (see page 247) and make sure that no air vents ⑤ are blocked.
 - ▶ Do not close the lid of the charging case during charging.
 - ▶ Do not expose the charging case to heat sources and direct sunlight during charging.
-

- ▶ Place the charging case on a flat, horizontal surface as shown.

- ▶ If necessary, lock the casters ③ of the ADN-W CASE BASE case bottom in place by pushing the locking lever downwards (see page 227).

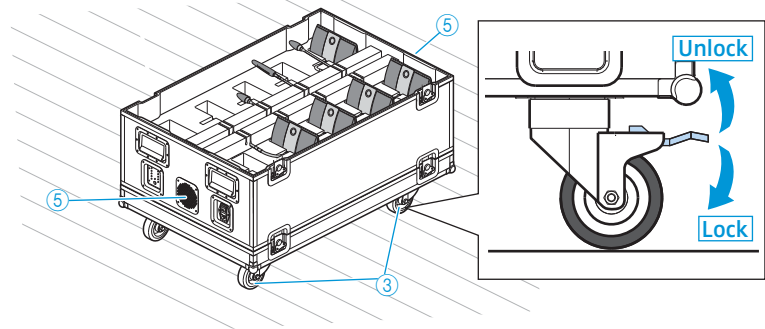

Connecting the charging case to and disconnecting it from the mains power supply

CAUTION

Product damage due to an unsuitable power supply!

If you connect the charging case to an unsuitable power supply, this can cause damage to the device.

- ▶ Use a mains cable with a 3-pin IEC mains connector to ensure a reliable mains ground connection of the charging case – especially when you are using an extension cable or a multi-outlet power strip.
- ▶ Avoid circuit overloading. If necessary, provide overcurrent protection.

To connect the charging case to the mains power supply:

- ▶ Connect the connector of the mains cable to the mains socket ⑦.
- ▶ Connect the mains plug (EU, UK or US plug) of the mains cable to the mains power supply. Ensure a secure fit of the mains plug in the wall socket. The charging case is now ready for operation.

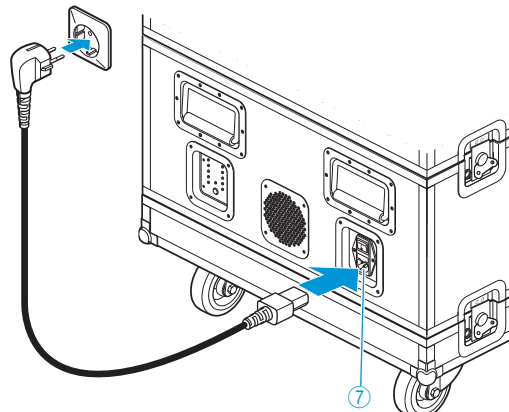

To disconnect the charging case from the mains power supply:

- ▶ Pull out the mains plug from the wall socket.

Charging the ADN-W BA battery pack

The ADN-W BA battery pack can be charged:

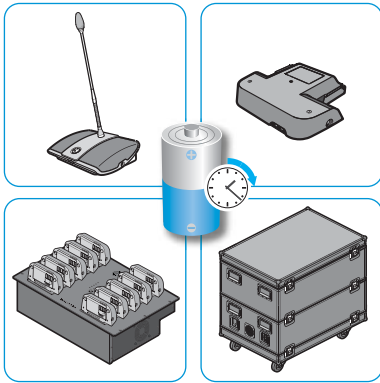

- while it is inserted in the wireless conference unit using the NT 12-50C power supply – even during operation
- separately using the NT 12-50C power supply,
- separately in the ADN-W L 10 charger,
- while it is inserted in the wireless conference unit using the ADN-W CASE UNITS charging case



i For optimum performance, durability and maintenance of the ADN-W BA battery pack, please observe the following:

- You can immediately use the ADN-W BA battery pack (battery capacity of approx. 30% upon delivery). You only have to recharge the battery pack when the battery charge is low. An initialization charge is not necessary.
- You can charge the battery pack at any time and for as long as you want. A complete charge cycle (100%) is not necessary.
- You do not have to regularly deep-discharge the battery pack to reach an optimum battery life cycle.
- If the displayed remaining operating time of the battery pack significantly differs from the actual operating time, you can re-calibrate the operating time display. To do so, completely discharge the battery pack and then fully recharge it again (100%).
- After charging, the battery pack can remain in the charger. The intelligent charging electronics monitors the charging process and prevents incorrect battery charging.
- When not using the wireless conference unit for extended periods of time, remove the battery pack from the device. Cover the contacts to avoid short circuits.
- When storing the battery pack for extended periods of time, charge it to approx. 50% of capacity.
- Only store the battery pack within the specified storage temperature range (see page 245).

Checking the charge status of the battery pack

▶ Press the button ⑤.

The charge status display ⑥ shows the current battery capacity for approx. 5 seconds:

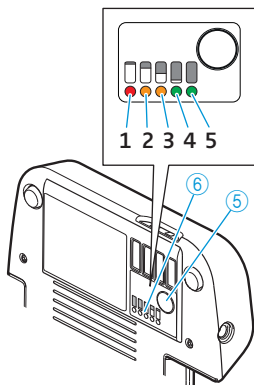

LED	Color	Remaining capacity	Remaining operating time
1	red	approx. 0-19%	approx. 0-4 hours
2	orange	approx. 20-39%	approx. 4-8 hours
3	orange	approx. 40-59%	approx. 8-12 hours
4	green	approx. 60-79%	approx. 12-16 hours
5	green	approx. 80-100%	approx. 16-20 hours

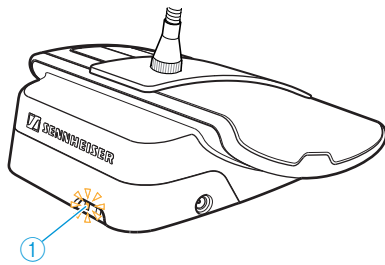

During operation, the battery status indicator ① additionally indicates when the battery pack is almost flat.

Status LEDs	Color	Meaning
Battery status indicator ①	–	Battery capacity 5-100%
	orange, flashing slowly	Battery capacity < 5%, battery pack is almost flat
	orange, flashing rapidly	Battery pack is defective

Charging the battery pack using the NT 12-50C power supply

Using the NT 12-50C power supply, you can charge the ADN-W BA battery pack separately or while it is inserted in the wireless conference unit. The wireless conference unit can be used during charging.

CAUTION

Product damage due to an unsuitable power supply!

If you use an unsuitable power supply, this can cause damage to the ADN-W BA battery pack.

- ▶ Only use the NT 12-50C power supply to charge the ADN-W BA battery pack.

To connect the NT 12-50C power supply:

- ▶ Connect the hollow jack plug ② of the NT 12-50C power supply to the hollow jack socket ④ of the ADN-W BA battery pack.
- ▶ Connect the Euro 8 connector of the mains cable to the socket ③ of the NT 12-50C power supply.
- ▶ Connect the mains plug of the mains cable to a wall socket. The battery pack is being charged and the battery status indicator ① lights up orange (see “Behavior of the ADN-W BA battery pack during charging” on page 55).

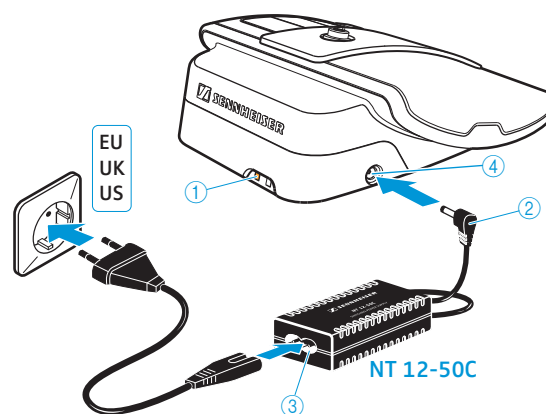

Simultaneously charging up to 10 battery packs in the ADN-W L 10 charger

- ▶ Set the on/off switch ⑤ of the charger to position “I”. The charger switches on. The operation indicator ③ lights up green.

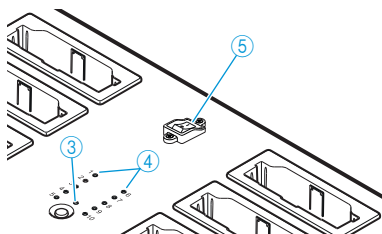

- ▶ Insert the battery pack into any charging compartment ① until it locks into place.

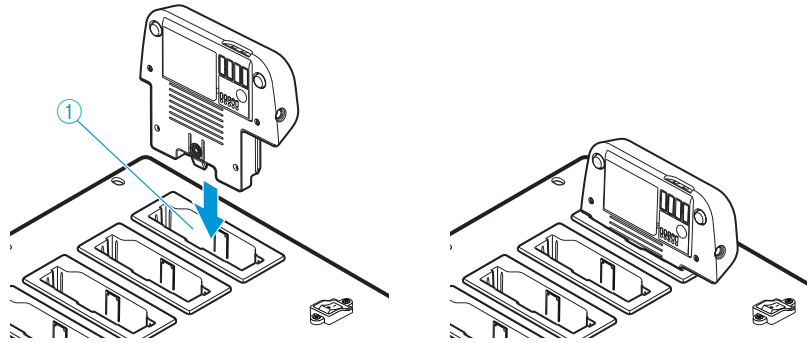

The battery pack is being charged (see “Behavior of the ADN-W BA battery pack during charging” on page 55). The status display ④ indicates the charging process (see “The status display of the ADN-W L 10/ADN-W CASE UNITS charger during charging” on page 54).

Simultaneously charging up to 10 battery packs in the ADN-W CASE UNITS charging case

CAUTION

Danger of heat accumulation in a closed charging case!

The ADN-W CASE UNITS charging case and the ADN-W BA battery packs can get hot during charging. If the heat cannot dissipate, the charging time increases and the products can be damaged.

- ▶ Only operate the charging case in closed rooms and within the specified operating temperature range and air humidity range (see page 247) and make sure that no air vents ⑤ are blocked.
- ▶ Do not close the lid of the charging case during charging.
- ▶ Do not expose the charging case to heat sources and direct sunlight during charging.

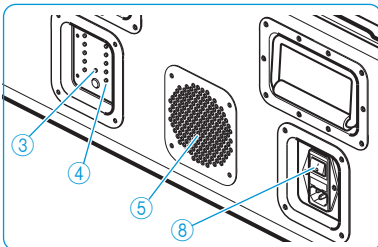

- ▶ Set the on/off switch ⑧ of the charging case to position “I”. The charging case switches on. The operation indicator ③ lights up green.

If, during charging, the gooseneck microphones of the wireless conference units are not supposed to protrude from the charging case:

- ▶ If necessary, carefully bend the ADN-W MIC 15-39, ADN-W MIC 15-50 and ADN-W MIC 36-50 gooseneck microphones sideways.
- ▶ If necessary, unscrew the ADN-W MIC 36-29 gooseneck microphones from the conference units (see page 46).
- ▶ Insert the wireless conference unit with the battery pack installed into any charging compartment ① as shown.

The battery pack is being charged (see “Behavior of the ADN-W BA battery pack during charging” on page 55). The status display ④ indicates the charging process (see “The status display of the ADN-W L 10/ADN-W CASE UNITS charger during charging” on page 54).

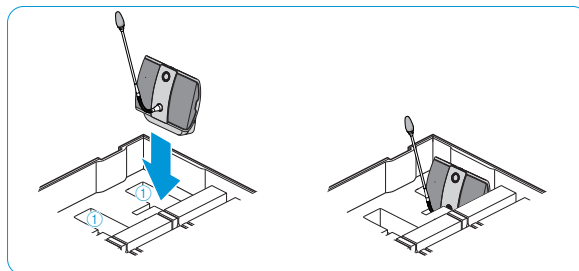

Switching off the ADN-W L 10/ADN-W CASE UNITS charger

To switch off the ADN-W L 10/ADN-W CASE UNITS charger after use:

- ▶ Set the on/off switch of the charger to position "0".
The charger switches off. The operation indicator goes off.

To disconnect the ADN-W L 10/ADN-W CASE UNITS charger from the mains power supply:

- ▶ Pull out the mains plug from the wall socket.

The status display of the ADN-W L 10/ADN-W CASE UNITS charger during charging

The status display ④ on the charger shows the **overall monitoring** of all charging compartments (each LED is assigned to a charging compartment):

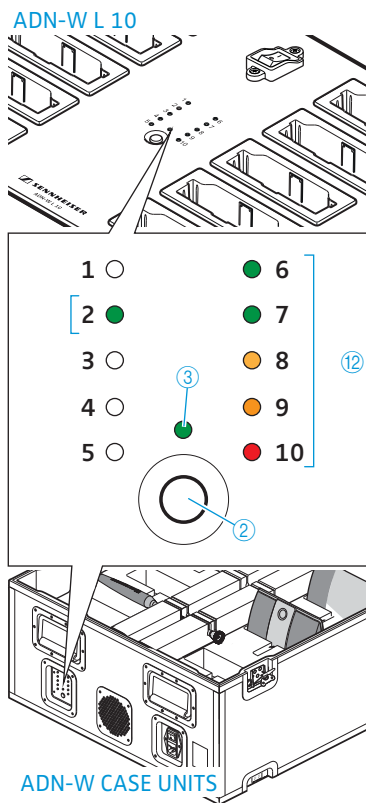

LED ④	Color	Capacity obtained
1-10	–	Standby operation; no battery pack inserted or no connection to the mains power supply
	red	approx. 0-19%
	orange	approx. 20-94%
	green	approx. 95-100% Typical charging time is 4 hours with subsequent continuous capacity monitoring
	red, flashing rapidly	Battery pack's temperature is too high
	red, flashing slowly	Battery pack is defective

To call up the **individual compartment monitoring**:

- ▶ Press the button for charge status indication ②.
The status display switches from overall monitoring to individual compartment monitoring. The LED (1-10) of the selected charging compartment (1-10) lights up green (see diagram as an example for charging compartment 2 ⑩). The adjacent LED strip comprising 5 LEDs displays the charge status in detail (see diagram as an example for a fully charged battery pack ⑫).

LED ④	Color	Capacity obtained
1 or 6	green	approx. 80-100% Typical charging time is 4 hours with subsequent continuous capacity monitoring
2 or 7	green	approx. 60-79%
3 or 8	orange	approx. 40-59%
4 or 9	orange	approx. 20-39%
5 or 10	red	approx. 0-19%
5 or 10	red, flashing rapidly	Battery pack's temperature is too high
5 or 10	red, flashing slowly	Battery pack is defective

To select the charging compartments 1 to 10 one after the other:

- ▶ Press the button ②.

5 seconds after the last button press, the status display switches back from individual compartment monitoring to overall monitoring.

i The labeling of the LEDs is only available on the ADN-W L 10 charger.

Behavior of the ADN-W BA battery pack during charging

When charging the battery pack using the NT 12-50C power supply or the ADN-W L10 or ADN-W CASE UNITS chargers, the battery pack and the corresponding charger will get warm. The battery status indicator ① and the charge status display ⑥ indicate the charging process:

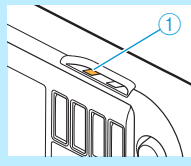
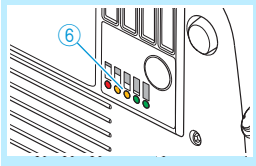
Battery status indicator ①	Charge status display ⑥	Meaning
lights up orange	lights up (the current charge status flashes)	Battery pack is being charged, a complete charging process takes approx. 4 hours
off	off	Battery pack is fully charged, continuous capacity monitoring
orange, flashing rapidly	–	Battery pack is defective
		

Charging may take longer if the temperature of the battery pack is below 10°C or over 45°C. In this case, in order to protect the battery pack, the charging process is interrupted until the temperature is again within the admissible range and the battery status indicator ① lights up orange. The charging process starts automatically.

Setting up the conference system

CAUTION

Product damage due to an unsuitable power supply!

If you connect standard network devices with RJ45 plugs (e.g. switches or network cards) to the connection sockets **PORT I**, **PORT II**, **DATA PS** and , the network devices can be damaged due to an unsuitable power supply.

- ▶ Only connect ADN C1 and ADN D1 conference units, ADN PS power supplies and the ADN-W AM antenna module to the connection sockets **PORT I**, **PORT II**, **DATA PS** and .

Basic information on the set-up of the conference system

Regardless of the number of conference units and the room size, we recommend the following procedure for setting up the conference system:

- ▶ Decide if you require wired conference units or mobile wireless ones. You can also combine wired and wireless conference units (mixed operation).
- ▶ Plan the number of conference units required for your conference system. A total of 400 conference units (of which up to 150 can be wireless) can be used in a conference system (see page 28). Always take the largest possible number of participants as a starting point.

If you are using wired conference units:

- ▶ Plan if simple cabling is sufficient or if you require a redundant ring topology (see page 28).
- ▶ If necessary, calculate the number of ADN PS power supplies required (a maximum of 15 ADN PS power supplies can be used in a conference system).
- ▶ If necessary, calculate the maximum length of the cabling in order to ensure that all conference units connected are supplied with sufficient voltage (see page 28).
- ▶ Place the ADN CU1 central unit and, if necessary, the ADN PS power supplies e.g. in the electrical equipment room or in the conference room.
- ▶ Place the conference units at the corresponding seats.
- ▶ Put out a sufficient number of SDC CBL RJ45 system cables in the required lengths (see "Components and accessories" on page 237).

 When connecting the conference units to an ADN PS power supply, you can mix different cable topologies (simple cabling or redundant ring topology) as long as you ensure correct cabling and comply with the specifications (see page 58 and page 60).

If you are using wireless conference units:

- ▶ Place the ADN CU1 central unit e.g. in the electrical equipment room or in the conference room. If possible, place the ADN CU1 central unit in the electrical equipment room or in the conference room and, if possible, place the ADN-W AM antenna module(s) directly in the conference room. The transmission range of the antenna module is approx. 30 m.
- ▶ Place the operational wireless conference units at the corresponding seats.

 • We recommend using several antenna modules in rooms with obstacles.
• In some countries/regions (e.g. Canada), the use of wireless components operating in the 5.15 to 5.25 GHz frequency band (channel 5 to 8) is restricted to indoor use.

Setting up a small wired conference system with only the central unit

For a small wired conference system, you do not require ADN PS power supplies.

Connecting conference units connected in a cable string to the ADN CU1 central unit

The following describes how to connect one cable string to the ADN CU1 central unit. If necessary, repeat these steps for a second cable string.

- ▶ Use a system cable to connect the **PORT II** socket ⑧ or **PORT I** socket ⑨ of the ADN CU1 central unit to the **IN** socket ⑩ of the first conference unit.
- ▶ Use a system cable to connect the **OUT** socket ⑪ the first conference unit to the **IN** socket ⑩ of the second conference unit.
- ▶ Repeat these steps for additional conference units.
- ▶ If necessary, repeat all steps for a second cable string.

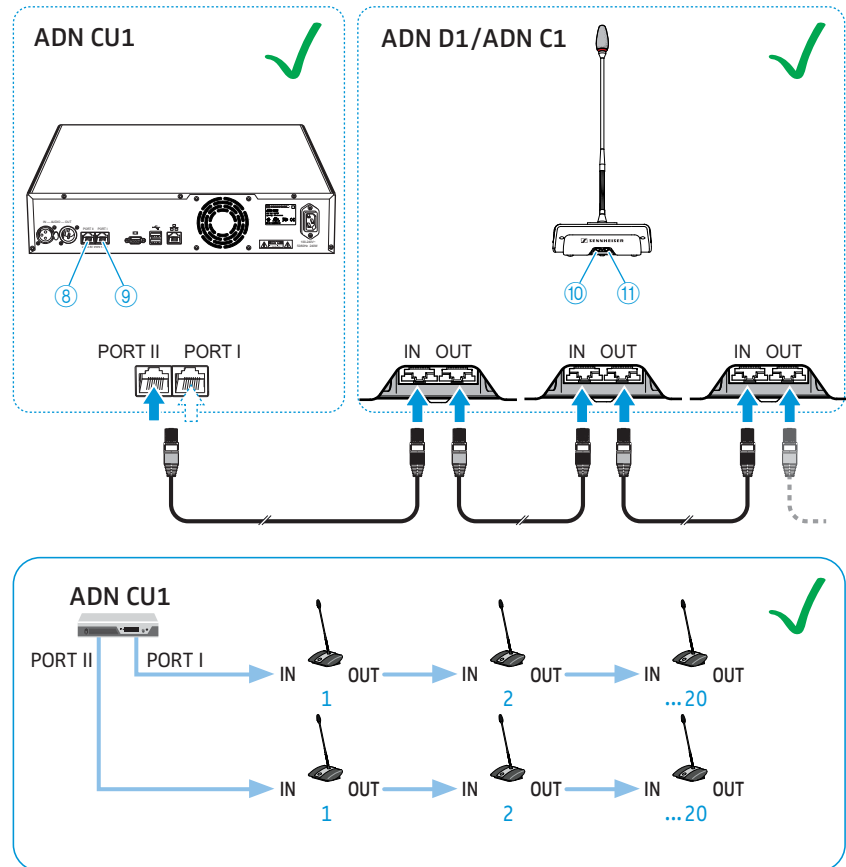

i Please note that there is a limited number of approx. 15-20 conference units per cable string due to the voltage drop on the cable string (see page 29).

Setting up a large wired conference system with ADN PS power supplies connected to the ADN CU1 central unit

For conference systems comprising more than 40 conference units or when the conference units are connected in a redundant ring topology, you require ADN PS power supplies. A maximum of 15 ADN PS power supplies can be used in a conference system.

- ▶ Use a system cable to connect the **PORT II** socket ⑧ or **PORT I** socket ⑨ of the ADN CU1 central unit to the **DATA CU/PS** input socket ⑩ of the first ADN PS power supply (the maximum cable length allowed is 50 m).
- ▶ Use a system cable to connect the **DATA PS** output socket ⑪ of the first ADN PS power supply to the **DATA CU/PS** input socket ⑩ of the second ADN PS power supply.
- ▶ Repeat these steps for the remaining ADN PS power supplies.

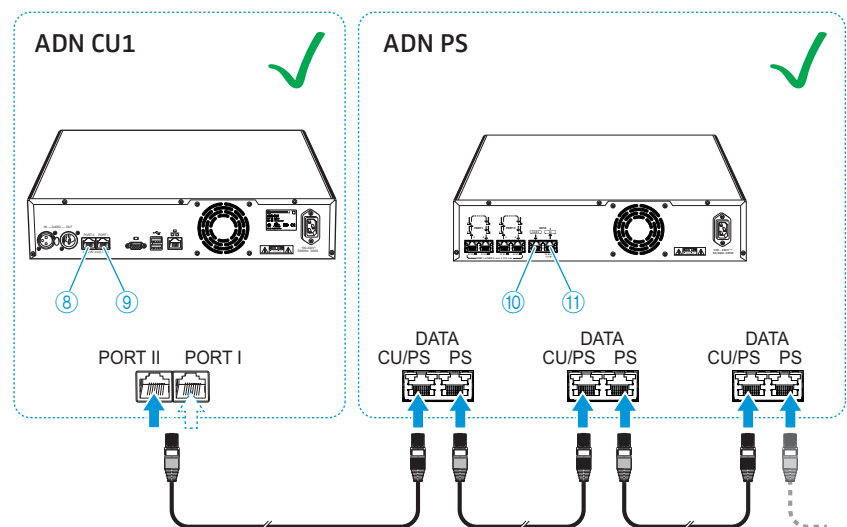

Setting up a large conference system comprising ADN PS power supplies and conference units connected in cable strings

For large conference systems with up to 400 conference units, you require ADN PS power supplies. When the conference units are connected in simple strings, one ADN PS power supply can power approx. 60-70 conference units.

Connecting conference units connected in a cable string to the ADN PS power supply

The following describes how to connect one cable string to an ADN PS power supply. If necessary, repeat these steps for additional cable strings and additional ADN PS power supplies.

- ▶ Connect the required number of ADN PS power supplies to the ADN CU1 central unit (see page 58).
- ▶ Use a system cable to connect the **PORT I** or **PORT II** socket – output 1 ⑥ / ⑧ or 2 ⑦ / ⑨ – of the ADN PS power supply to the **IN** socket ⑩ of the first conference unit.
- ▶ Use a system cable to connect the **OUT** socket ⑪ of the first conference unit to the **IN** socket ⑩ of the second conference unit.
- ▶ Repeat these steps for additional conference units.
- ▶ If necessary, repeat all steps for a second, third or fourth cable string and for additional ADN PS power supplies.

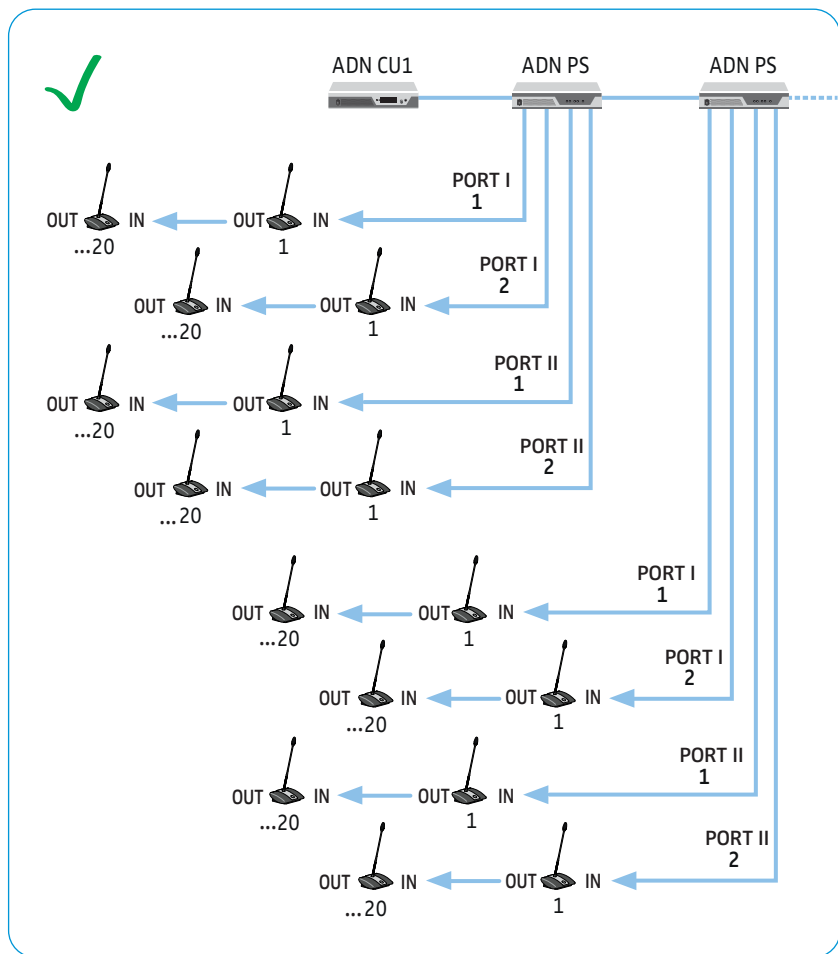
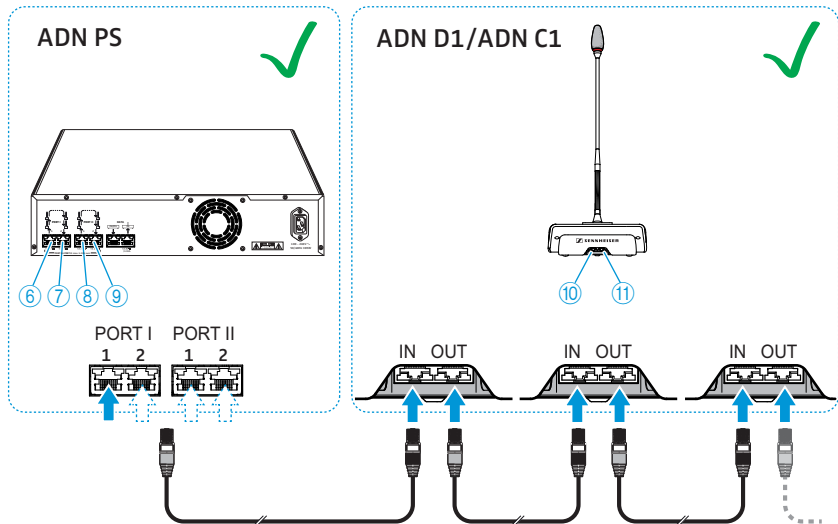

i Please note that there is a limited number of approx. 15-20 conference units per cable string due to the voltage drop on the cable string (see page 29).

One ADN PS power supply can power a total of 60-70 conference units if all connection sockets (**PORT I** and **PORT II**/outputs **1** and **2**) are used.

Setting up a large conference system comprising ADN PS power supplies and conference units connected in redundant ring topology

In large conference systems with up to 400 conference units, the redundant ring topology ensures that, should one conference unit or system cable fail or be manipulated, all other conference units of the cable ring will continue to function reliably. When the conference units are connected in ring topology, one ADN PS power supply can power approx. 30-40 conference units.

i To ensure full operational reliability in a redundant ring topology, the hardware of the ADN C1 and ADN D1 has been revised. If you combine conference units with hardware revision 1 (no marking on the type plate) and conference units with hardware revision 2 ("HW: v2" is printed on the type plate), fail-safe operation is only possible to a limited extent (see also page 111).

- ▶ In a redundant ring topology, only use conference units with hardware revision 2.

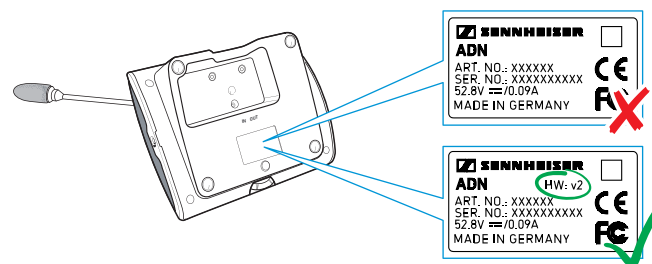

Connecting conference units connected in a cable ring to the ADN PS power supply

The following describes how to connect one cable ring to an ADN PS power supply. If necessary, repeat these steps for a second cable ring and additional ADN PS power supplies.

- ▶ Connect the required number of ADN PS power supplies to the ADN CU1 central unit (see page 58).
- ▶ Use a system cable to connect output 1 ⑥ of the PORT I socket of the ADN PS power supply to the IN socket ⑩ of the first conference unit.
- ▶ Use a system cable to connect the OUT socket ⑪ of the first conference unit to the IN socket ⑩ of the second conference unit.
- ▶ Repeat these steps for additional conference units.
- ▶ Use a system cable to connect the OUT socket ⑪ of the last conference unit in the cable ring to output 2 ⑦ of the PORT I socket of the ADN PS power supply.
- ▶ If necessary, repeat all steps for a second cable ring on PORT II and the additional ADN PS power supplies.

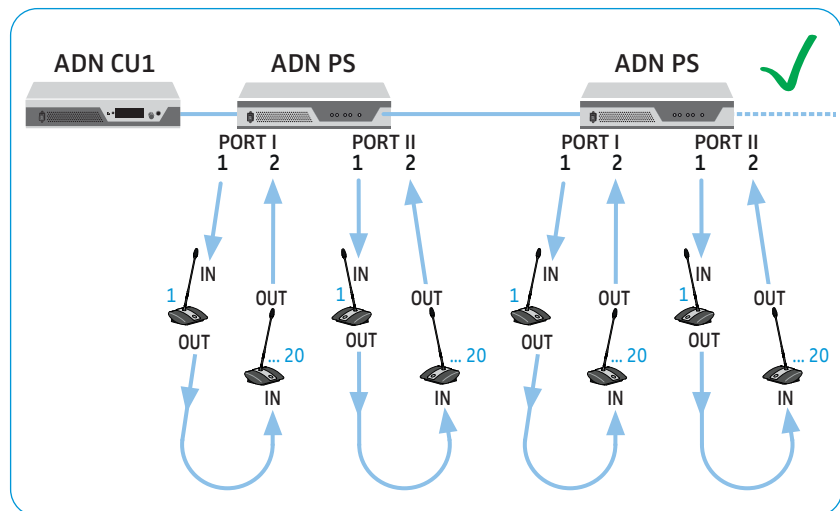
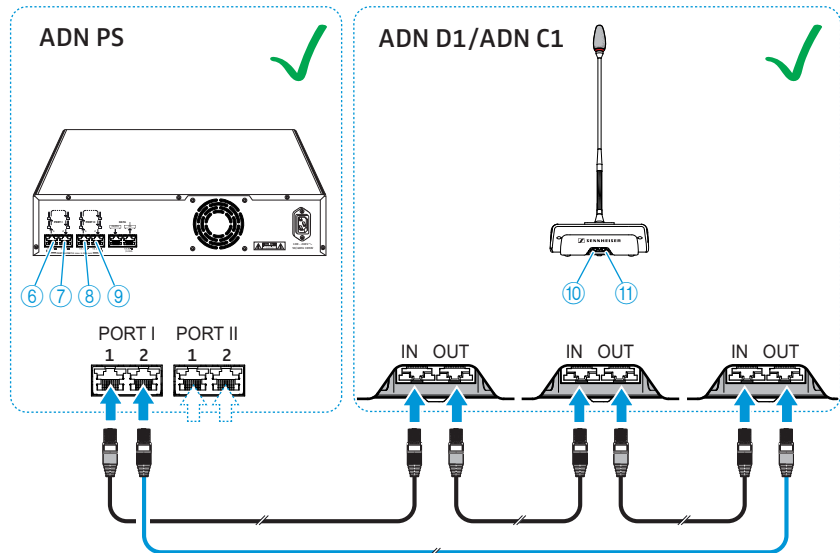

i Please note that there is a limited number of approx. 15-20 conference units per cable string due to the voltage drop on the cable ring (see page 29).

Cabling errors

If the cabling is wrong, the system may perhaps function, but operational reliability is compromised and monitoring cannot be carried out reliably. Therefore, avoid the following severe cabling errors:

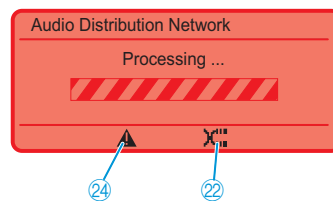

IN socket and OUT socket on one conference unit have been accidentally swapped

The IN socket and the OUT socket on one conference unit in the cable string have been accidentally swapped.

The warning triangle ②④, the cable fault icon ②② and the "Processing ..." bar appear on the display panel of the ADN CU1 central unit (see page 105).

The microphone LED ⑧ and the signal light ring ② of the conference unit in question flash red.

To eliminate the error:

- ▶ Connect the conference unit correctly (see page 57).

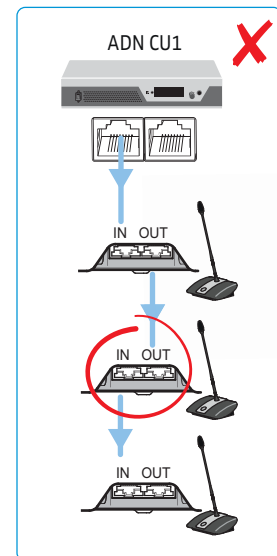

Ring topology connected to the ADN CU1 central unit

A ring topology cannot be connected to the ADN CU1 central unit. A ring topology can only be connected to an ADN PS power supply.

The error message "Error 60007 Ring cabling at CU1 ports" appears on the display panel of the ADN CU1 central unit. The display panel lights up red.

To eliminate the error:

- ▶ Set up the conference system correctly (see page 57).
- ▶ Switch the conference system on again (see page 77).

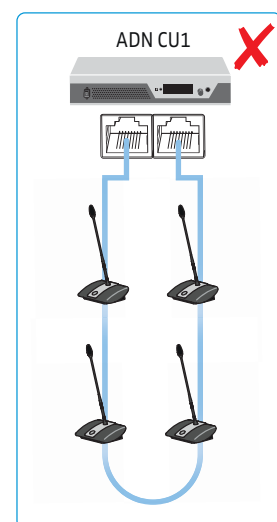

DATA socket of an ADN PS power supply connected to a PORT I/II socket of an ADN PS power supply

The DATA PS output socket of an ADN PS power supply must not be connected to a PORT socket.

The error message "Error 60004 PS unit at PS conference port" appears on the display panel of the ADN CU1 central unit. The display panel lights up red.

On the ADN PS power supply to which another ADN PS power supply is wrongly connected, all PORT status LEDs flash orange.

On the ADN PS power supply whose PORT socket is wrongly connected, the corresponding PORT status LED flashes orange.

To eliminate the error:

- ▶ Set up the conference system correctly (see page 58).
- ▶ Switch the conference system on again (see page 77).

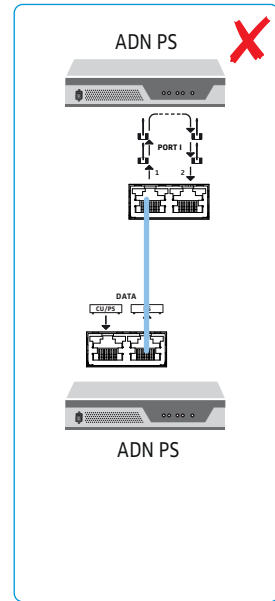

Conference units connected to the DATA socket of the ADN PS power supply

No conference units must be connected to the DATA PS output socket of an ADN PS power supply.

The error message "Error 60003 D1/C1 at PS cascading port" appears on the display panel of the ADN CU1 central unit. The display panel lights up red.

On the ADN PS power supply to which conference units are wrongly connected, all PORT status LEDs flash orange.

The signal light ring ② and the microphone LED ③ of the conference units flash red.

To eliminate the error:

- ▶ Set up the conference system correctly (see page 58).
- ▶ Switch the conference system on again (see page 77).

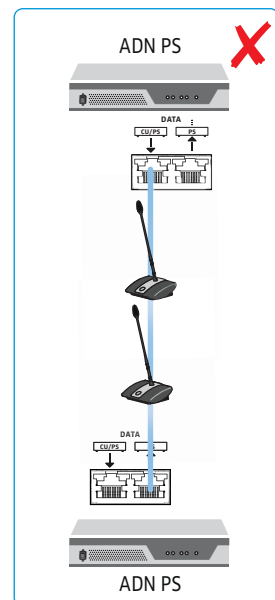

Ring topology connected to different PORT sockets of an ADN PS power supply

A ring topology cannot be connected to different PORT sockets of an ADN PS power supply.

The error message "Error 60005 Ring cabling between port I+II" appears on the display panel of the ADN CU1 central unit. The display panel lights up red.

On the ADN PS power supply, the respective status LED for the PORT I and PORT II outputs in question flashes orange.

To eliminate the error:

- ▶ Set up the conference system correctly (see page 58).
- ▶ Switch the conference system on again (see page 77).

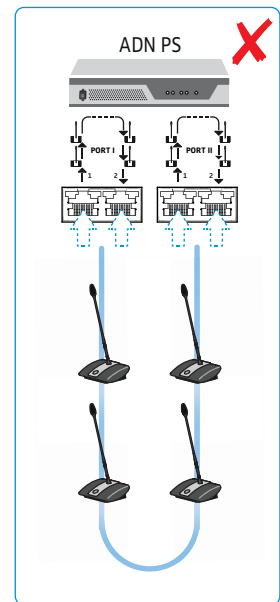

Ring topology connected to different ADN PS power supplies

A ring topology cannot be connected to different PORT sockets of two different ADN PS power supplies.

The error message "Error 60006 Ring cabling between two PS" appears on the display panel of the ADN CU1 central unit. The display panel lights up red.

On the two ADN PS power supplies, the respective status LED for the PORT outputs in question flashes orange.

To eliminate the error:

- ▶ Set up the conference system correctly (see page 58).
- ▶ Switch the conference system on again (see page 77).

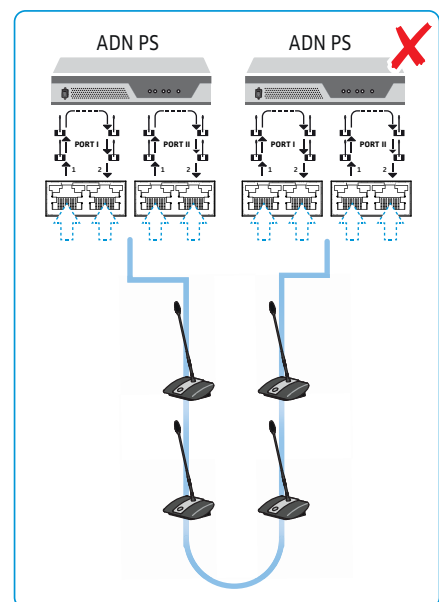

Ring topology connected to the wrong outputs of a PORT socket

The ring topology is connected to the wrong outputs of the PORT socket.

The conference units connected in the cable ring do not function and are not displayed in the "Units" menu item of the ADN CU1 central unit's "System Menu". The "Topology" menu item of the "System Menu" nevertheless displays "ring topology" for the PORT in question.

To eliminate the error:

- ▶ Set up the conference system correctly (see page 58).
- ▶ Switch the conference system on again (see page 77).

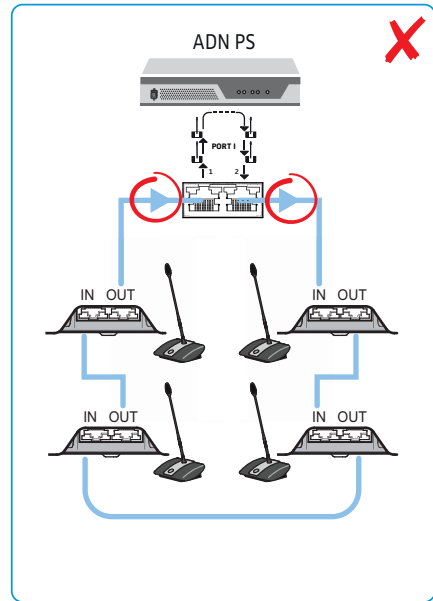

Wrongly connected conference unit in the cable ring

The IN socket and the OUT socket on one conference unit in the cable ring have been accidentally swapped.

The wrongly connected conference unit in the cable ring does not function and is not displayed in the "Units" menu item of the ADN CU1 central unit's "System Menu".

To eliminate the error:

- ▶ Set up the conference system correctly (see page 58).
- ▶ Switch the conference system on again (see page 77).

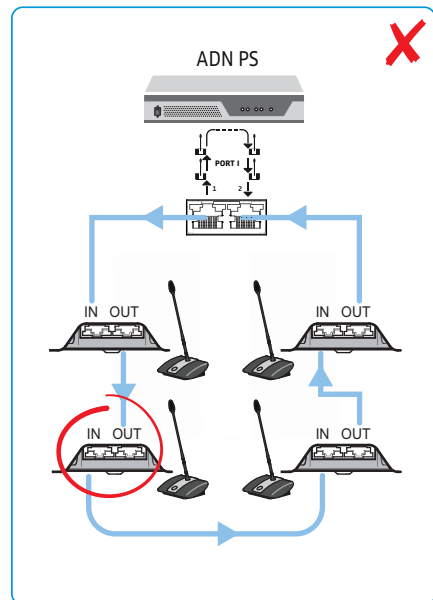

Connecting the ADN-W AM antenna module to the ADN CU1 central unit

For operating the wireless conference units, you require at least one ADN-W AM antenna module.

- ▶ Use a system cable (supplied with the ADN-W AM; the maximum cable length allowed is 50 m) to connect the **PORT II** socket ⑧ or **PORT I** socket ⑨ of the ADN CU1 central unit to the input socket ⚡ ④ of the ADN-W AM antenna module.

i If the power supplied to the antenna module via the system cable is not sufficient (the antenna module does not switch on), you have to power the antenna module using the NT 12-50C power supply (see page 43).

i Optionally, you can also connect the antenna module to the **PORT** sockets of an ADN PS power supply. It does not matter if you are using a string or ring topology. The antenna module is connected just like a conference unit to the cable string or cable ring.

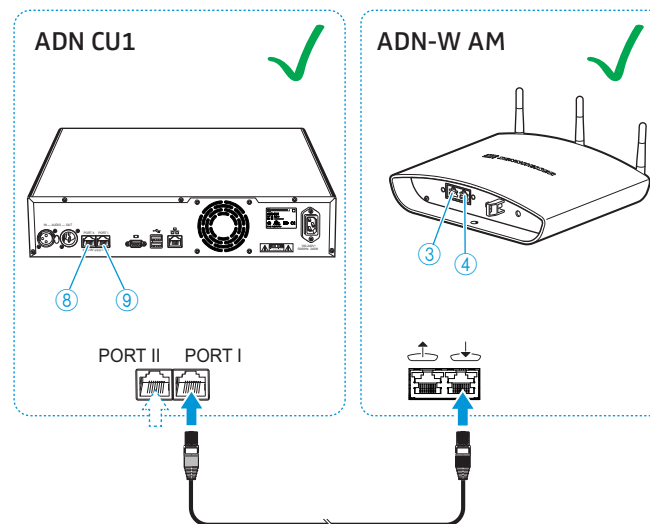

To optionally combine the antenna module with wired conference units (hybrid operation), connect the antenna module just like a wired conference unit:

- ▶ Use a system cable to connect the output socket  ③ of the ADN-W AM antenna module to the IN socket ⑩ of an ADN D1/ADN C1 wired conference unit.

Or:

- ▶ Use a system cable to connect the OUT socket ⑪ of an ADN D1/ADN C1 wired conference unit to the input socket  of the ADN-W AM antenna module.

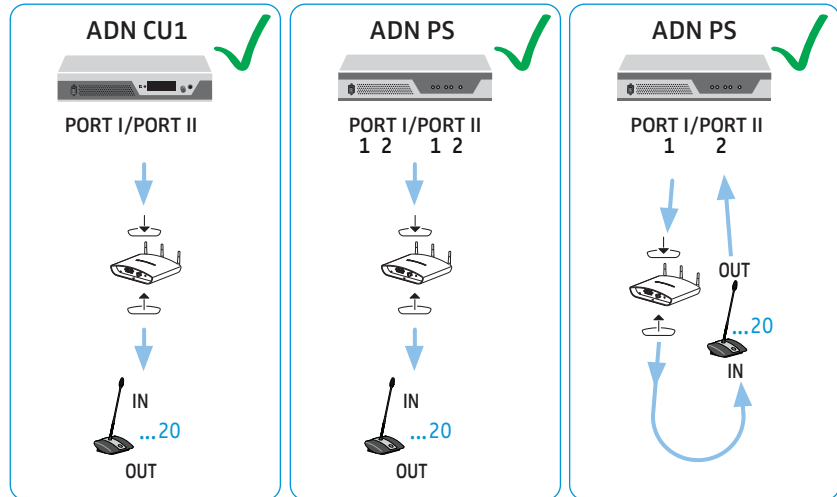

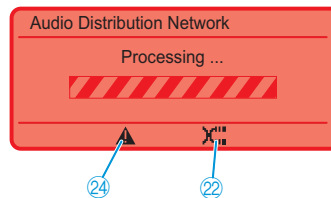

Cabling errors

If the cabling is wrong, the system may perhaps function, but operational reliability is compromised and monitoring cannot be carried out reliably. Therefore, when setting up a wireless conference system, avoid the following severe cabling errors:



Input socket and output socket on the ADN-W AM antenna module have been accidentally swapped

When connecting to the ADN CU1 central unit, the input socket  and the output socket  of the ADN-W AM antenna module have been accidentally swapped.

The warning triangle ④, the cable fault icon ② and the "Processing ..." bar appear on the display panel of the ADN CU1 central unit (see page 105).

The antenna module is not operational.

To eliminate the error:

- ▶ Connect the antenna module correctly (see page 66).

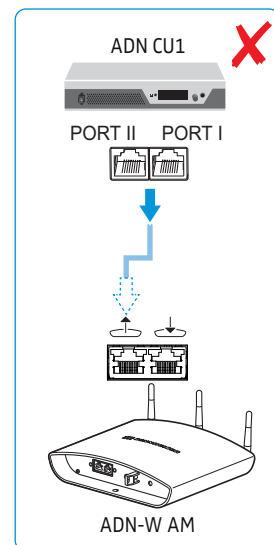

ADN-W AM antenna module connected to the DATA socket of the ADN PS power supply

No antenna module must be connected to the DATA PS output socket of an ADN PS power supply.

The error message "Error 60010 AM at PS cascading port" appears on the display panel of the ADN CU1 central unit. The display panel lights up red.

To eliminate the error:

- ▶ Set up the conference system correctly (see page 66).
- ▶ Switch the conference system on again (see page 77).

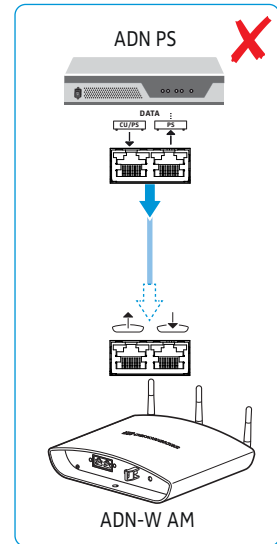

Wrongly connected ADN-W AM antenna module in the cable ring

The input socket and the output socket on the antenna module in the cable ring have been accidentally swapped.

The antenna module connected in the cable ring does not function and is not displayed in the ADN CU1 central unit's "System Menu".

To eliminate the error:

- ▶ Set up the conference system correctly (see page 66).
- ▶ Switch the conference system on again (see page 77).

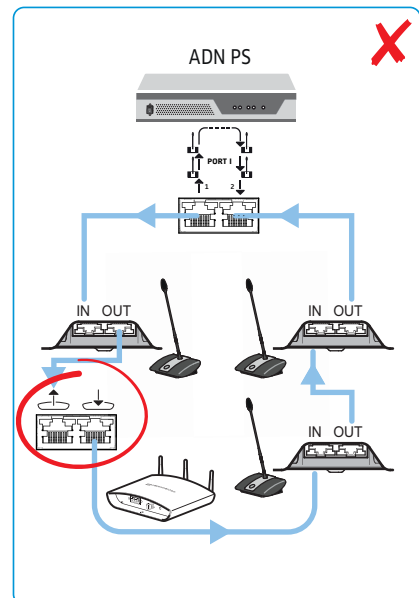

Setting up and positioning the antenna module



CAUTION

Danger of injury and material damage!

If improperly installed or insufficiently fixed, the antenna module can fall from the wall, ceiling or stand or tip over and can cause injury or material damage.

- ▶ Protect the antenna module against tipping or dropping by means of a safety wire which is attached to a separate hook.
- ▶ Always have the antenna module mounted by a qualified specialist according to local, national and international regulations and standards.

The antenna module can be:

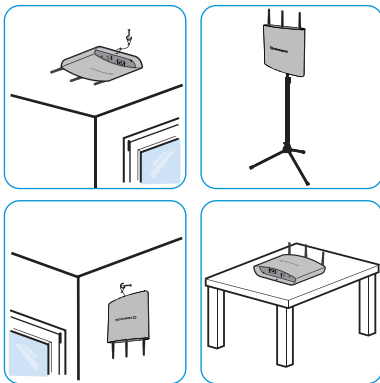

- mounted to a wall or ceiling by means of a ball joint (optional accessory),
- mounted to a stand or
- placed on a flat surface (e.g. table).



If necessary, use several antenna modules in order to provide optimal antenna coverage.

CAUTION

Danger of intermodulation!

If you set up the antenna module and the wireless conference units too close to one another, intermodulation can occur.

- ▶ Observe a minimum distance:
 - of 1 m between the wireless conference units and the antenna module and
 - of 0.5 m between the wireless conference units.

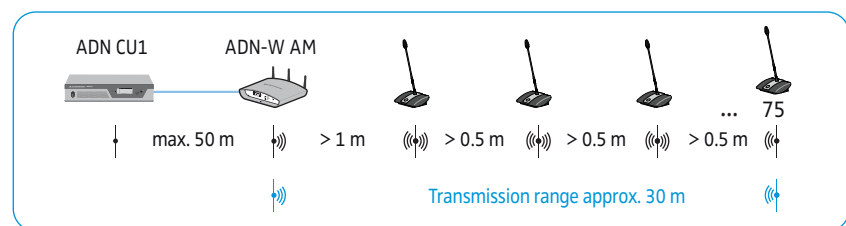

The transmission range of the antenna module and the wireless conference units is approx. 30 m. The transmission range can vary depending on location and environmental conditions such as wall thickness, wall composition etc.



- We recommend using several antenna modules in rooms with obstacles.
- In some countries/regions (e.g. Canada), the use of wireless components operating in the 5.15 to 5.25 GHz frequency band (channel 5 to 8) is restricted to indoor use.

- ▶ Do not obstruct the antennas of the antenna module and the wireless conference units with any object.

- ▶ Set up the devices so that there is a “free line of sight” between the wireless conference units and the antenna module.
- ▶ Place the antenna module as centrally as possible and above the wireless conference units.
- ▶ Orient the 3 antennas of the antenna module so that they are parallel to each other and are directed at a 90° angle towards the wireless conference units.

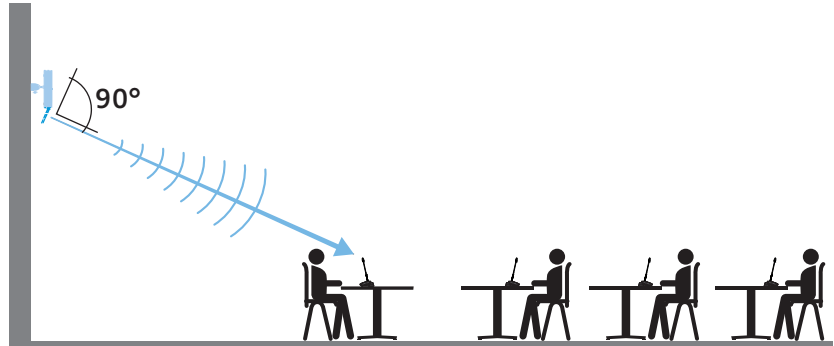
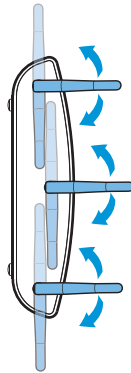
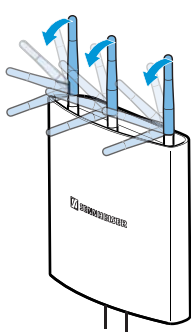

Ceiling mounting is recommended for rooms with a ceiling height of up to approx. 10 m:

- ▶ Mount the antenna module to the center of the ceiling. To do so, use the optional GZG 1029 swivel joint and GZP 10 mounting plate (see “Mounting the antenna module to the ceiling” on page 72).
- ▶ Orient the antennas horizontally and at a 90° angle with respect to the wireless conference units.

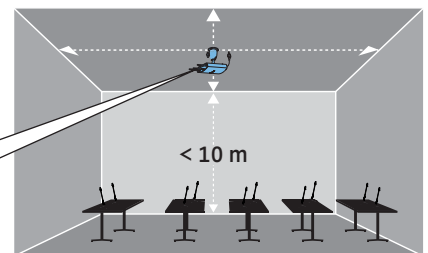
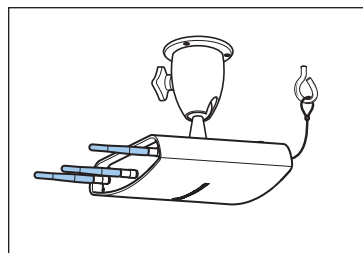

Wall mounting is recommended for rooms with a ceiling height of more than 10 m because the wireless conference units have an omni-directional radiation pattern (approx. 30 m):

- ▶ Mount the antenna module to the wall at a height of max. 10 m from the floor. To do so, use the optional GZG 1029 swivel joint and GZP 10 mounting plate (see "Mounting the antenna module to the ceiling" on page 72).
- ▶ Attach the antenna module upside down so that the antennas point downwards.
- ▶ Slightly turn the antennas so that they are directed at a 90° angle towards the wireless conference units.

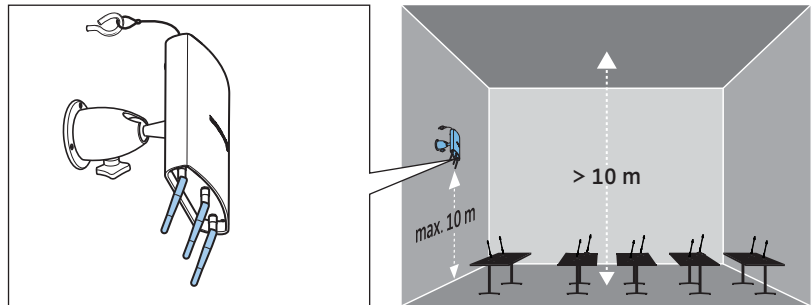

To minimize restrictions in the transmission range:

- ▶ Avoid placing the antenna module outside the conference room, behind support columns or boardings or next to other radio equipment.

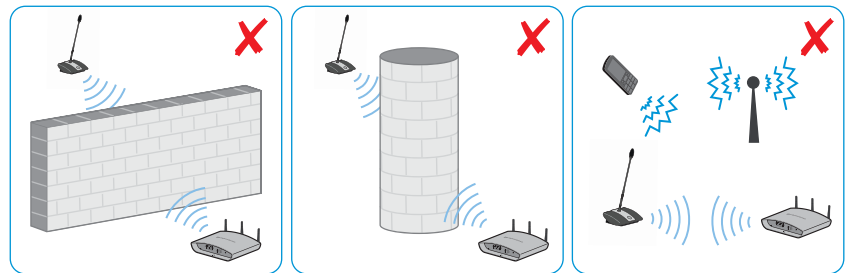

Mounting the antenna module to the wall

- ▶ Mount the antenna module to the wall by screwing two screws (pan head screws/flat head screws M4 x 25 or longer, to be ordered separately) through the mounting holes for wall mounting ⑧ at the rear of the antenna module.

i When mounting the antenna module very high (up to approx. 10 m) on a wall, use the optional GZG 1029 swivel joint and GZP 10 mounting plate (see "Mounting the antenna module to the ceiling" on page 72). Attach the antenna module upside down so that the antennas point downwards. This allows you to optimally orient the antennas towards the wireless conference units (see page 69).

To protect the antenna module from accidental dropping:

- ▶ Guide a safety wire through the hole for safety wire ① and attach the safety wire e.g. to a separate hook.

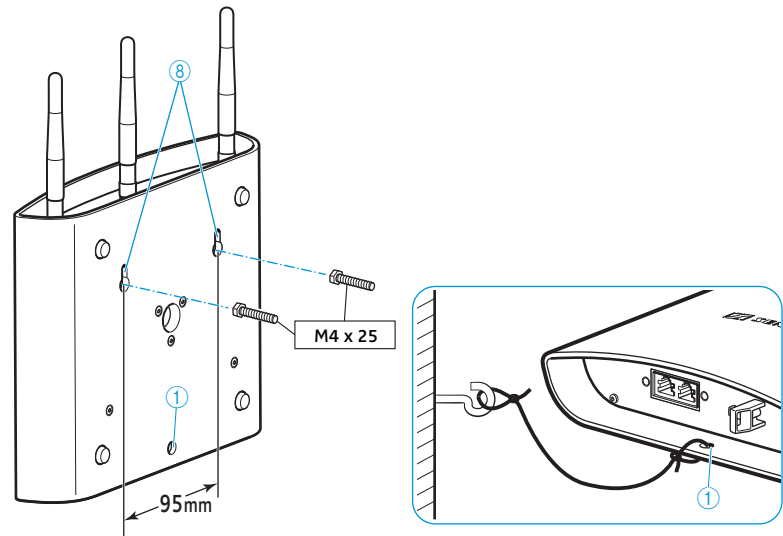

Mounting the antenna module to the ceiling

- ▶ For ceiling mounting, use the optional GZG 1029 swivel joint and GZP 10 mounting plate.

To protect the antenna module from accidental dropping:

- ▶ Guide a safety wire through the hole for safety wire ① and attach the safety wire e.g. to a separate hook.

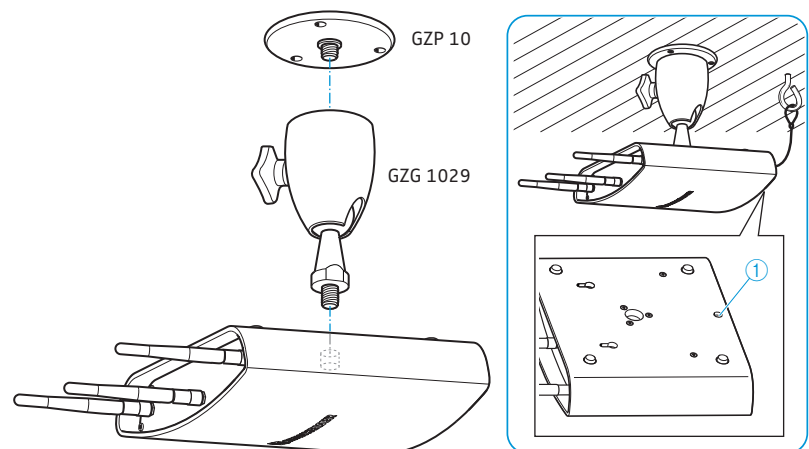

Mounting the antenna module to a stand

- ▶ Orient the legs of the stand.
- ▶ Select a suitable mounting thread (supplied) for your stand:
 - without thread insert: 5/8" thread
 - thread insert: 3/8" thread

- ▶ Screw the antenna module to the stand using the mounting thread ⑨.

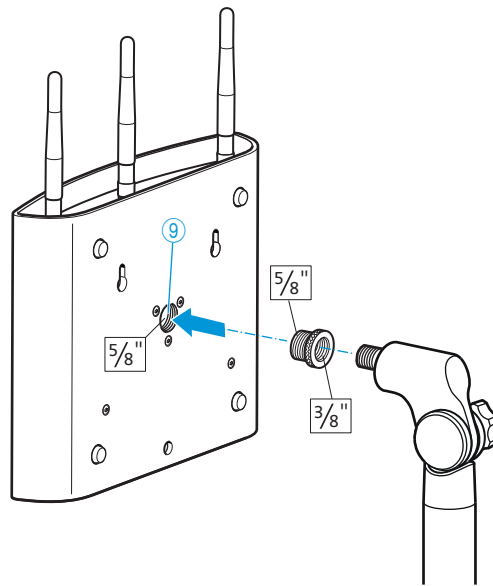

Placing the antenna module on a flat surface

- ▶ Place the antenna module on a flat surface.

Orienting the antennas

- ▶ Orient the 3 antennas so that they are parallel to each other and are directed at a 90° angle towards the wireless conference units (see page 69).

Setting up the ADN-W C1 or ADN-W D1 wireless conference units

CAUTION

Danger of intermodulation!

If you set up the ADN-W C1 or ADN-W D1 wireless conference units and the ADN-W AM antenna module too close to one another, intermodulation can occur.

- ▶ Observe a minimum distance:
 - of 1 m between the wireless conference units and the antenna module and
 - of 0.5 m between the wireless conference units.

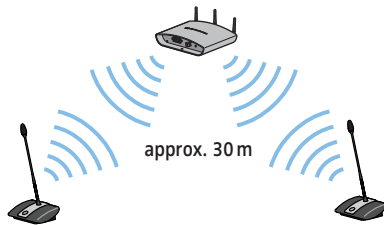
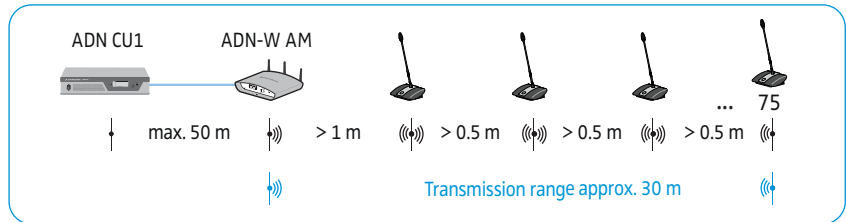

- ▶ Set up the devices so that there is a “free line of sight” between the ADN-W C1 or ADN-W D1 wireless conference units and the ADN-W AM antenna module.
- ▶ Configure the wireless components of the conference system (see page 81).

i In some countries/regions (e.g. Canada), the use of wireless components operating in the 5.15 to 5.25 GHz frequency band (channel 5 to 8) is restricted to indoor use.

Connecting external audio devices to the central unit

i You can use different settings for processing the audio signals of the **IN** audio input and the **OUT** audio output in order to avoid, for example, delayed or double audio signals in videoconferencing or teleconferencing systems (see page 100 or page 201).

To output the floor channel via an external audio device:

- ▶ Use an XLR cable to connect the **OUT** audio output ⑦ of the central unit to an external audio device.

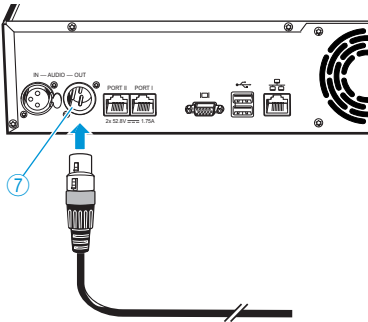

To connect an external audio source and to feed its signals to the floor channel:

- ▶ Use an XLR cable to connect the external audio source to the **IN** audio input ⑥ of the central unit.

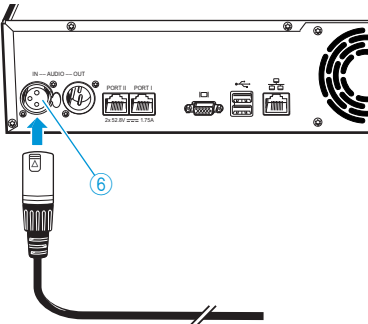

Connecting a USB mass storage device for audio recordings to the central unit

In order to be able to use the audio recording function of the ADN CU1 central unit (see page 122), you require a USB mass storage device with the following characteristics:

USB mass storage device	Requirements
Recommended memory size	> 500 GB
File system	NTFS FAT32
Partition	1
Connection	USB type A plug
Interface	USB 2.0
Power supply	via USB socket (approx. 500 mA) or separate mains unit

- ▶ Connect the USB mass storage device to one of the two USB sockets ⑪.
- ▶ If necessary, connect the mains unit of the USB mass storage device.

i Use a USB hub if the number of USB sockets ⑪ is not sufficient or if the USB mass storage device is too large for connection to the central unit.

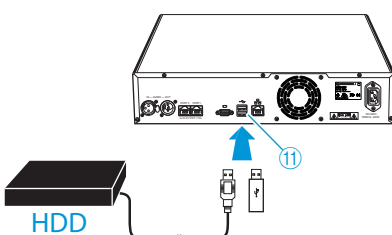

Preparing to use the “Conference Manager” software

Running the software installed on the central unit

To use the “Conference Manager” software installed on the central unit, you require the following devices:



Device	Requirements
Screen	Connection: 15-pin Sub-D VGA Resolution: 800 x 600 pixels or higher 1024 x 768 or 1280 x 1024 pixels recommended
Mouse	Standard USB for Windows PCs
Keyboard	Standard USB for Windows PCs Supported language layouts: e.g. English, German, French, Spanish, Italian, Russian, Dutch (for the complete list, see “Keyboard layouts” on page 254)

- ▶ Use a Sub-D VGA cable to connect a screen to the VGA monitor output ⑩.

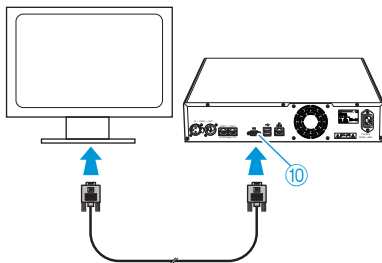

- ▶ Connect the keyboard and the mouse to the two USB sockets ⑪.
- ▶ Configure the screen, keyboard and mouse settings using the “Conference Manager” software (see page 151).
Your conference system is now ready for operation.

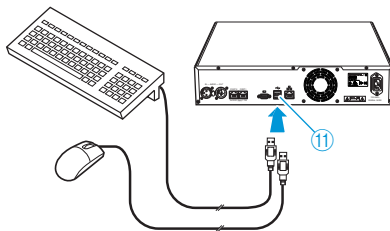

- Use a USB hub if the number of USB sockets ⑪ on the central unit is not sufficient.

Running the software on a separate Windows PC

To run the “Conference Manager” software on a separate Windows PC, the PC must meet the system requirements (see page 127).



- ▶ Use a network cable (Cat5) to connect the Ethernet socket ⑫ of the central unit to the network interface of your PC.

- You can also connect the PC and the central unit using a switch or similar.

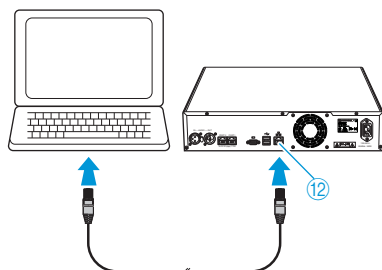

- ▶ Install the “Conference Manager” software supplied on the DVD-ROM on your connected PC (see page 127).
- ▶ Configure the network as described in the chapter “Preparing the Windows version of the software for use” on page 127.

Switching the conference system on/off

i The ADN PS power supplies and the ADN-W AM antenna module can only be switched on when the central unit ADN CU1 and the previous ADN PS connected in series are also switched on.

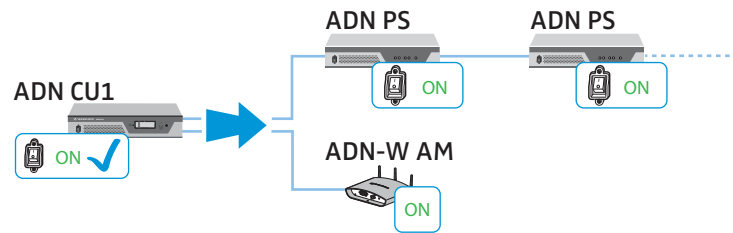

You can set up your conference system so that you can increase or reduce the number of wired conference units used by simply switching individual ADN PS on or off. The ADN-W AM antenna module allows you to expand the conference system with additional wireless conference units.

Switching on a conference system comprising wired conference units

▶ On the ADN CU1 central unit and the ADN PS power supplies, set the on/off switch ① or ② to position "I".

The central unit switches on and its display panel lights up. The power supplies switch on and their status LEDs light up:

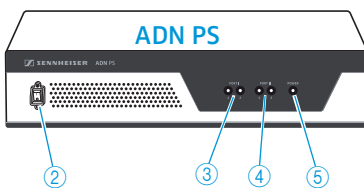
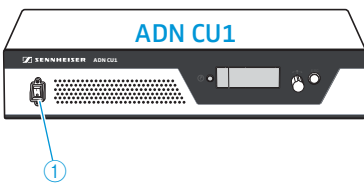

Status LED	Color	Meaning
POWER ⑤	green	ADN PS is switched on
PORT I ③ / Port II ④ output 1/2	–	not used, switched off
	orange	conference units are connected in strings
	green	conference units are connected in redundant ring topology via output 1 and 2
	flashing orange	error in a cable string, output is switched off

i When switching the conference system on the first time, select the desired language (see page 113). This manual shows screenshots of the English-language version of the central unit's operating menu.

Switching on the central unit and the antenna module

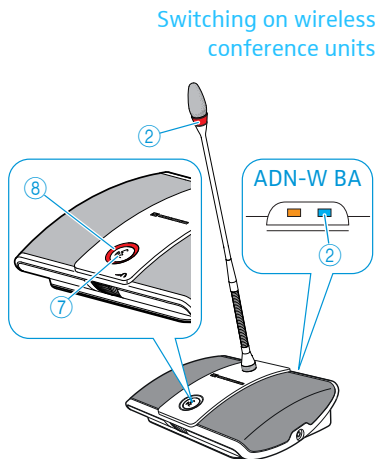

Switching on a conference system comprising an antenna module for wireless operation

▶ Set the on/off switch ① of the ADN CU1 central unit to position "1". The central unit switches on and its display panel lights up. The connected ADN-W AM antenna module is also switched on.

i If you are using ADN PS power supplies in a conference system in which wireless conference units are used, you have to switch on the ADN PS power supplies as well (see previous section).

▶ Press the microphone key ⑦.

The microphone LED ⑧ and the signal light ring ② flash red and the RF status indicator ② on the ADN-W BA battery pack flashes blue slowly. Once the initialization process is complete and after connection to the ADN-W AM antenna module is established, the microphone LED ⑧ and the signal light ring ② go off. The RF status indicator ② on the ADN-W BA battery pack indicates the transmission quality:

Status LED	Color	Meaning
RF status indicator ②	–	good transmission quality
	blue, flashing slowly	transmission quality is temporarily reduced (see page 82)
	blue, flashing rapidly	transmission quality is permanently reduced (see page 82)

The connection to the antenna module depends on the selected access mode (open or closed access mode, see page 96 or page 165).

i If no connection to an antenna module can be established within 5 minutes, the wireless conference unit automatically switches off.

Switching off the conference system

i If you have made changes to a configuration using the "Conference Manager" software, you have to save these changes before switching the central unit off (see page 157). All other settings of the central unit are automatically saved.

To switch off the **entire conference system**:

▶ Set the on/off switch ① of the ADN CU1 central unit to position "0". The central unit is switched off and the display panel goes off. All ADN PS power supplies connected to the central unit and switched on are switched off and the status LEDs go off.

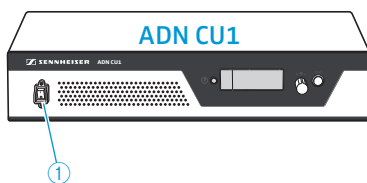

To switch off **individual ADN PS** power supplies:

▶ Set the on/off switch ② of the ADN PS power supply to position "0". The power supply is switched off and all status LEDs go off. Additional connected ADN PS power supplies are also switched off.

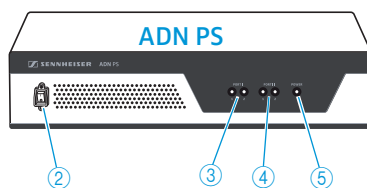

To switch off the **ADN-W AM** antenna module:

- ▶ Disconnect the system cable from the input socket  ④ of the antenna module.

The antenna module is switched off. All previously connected wireless conference units try to reconnect to the antenna module and automatically switch off after 5 minutes if no switched-on antenna module can be found.

To completely switch off the **ADN CU1** central unit, the **ADN PS** power supplies or the **ADN-W AM** antenna module:

- ▶ Pull out the mains plug of the ADN CU1 central unit or the mains plug of the ADN PS power supply or the NT 12-50C power supply of the antenna module from the wall socket.

Switching off wireless conference units

To switch off **all** wireless conference units:

- ▶ Set the on/off switch ① of the ADN CU1 central unit to position "0".
The central unit is switched off and the display panel goes off. The ADN-W AM antenna module connected to the central unit is switched off. All switched-on and connected wireless conference units are automatically switched off after 5 minutes.

 If you are using the "Conference Manager" software, you can also switch off all wireless conference units with a mouse click (see page 154).

To switch off **individual** wireless conference units:

- ▶ Press the microphone key ⑦ for 5 seconds.

Or:

- ▶ Remove the ADN-W BA battery pack from the conference unit (see page 47).
The conference unit switches off. All LEDs go off.

 If the conference mode is set to "Push to talk", you can only switch off the wireless conference unit by removing the battery pack.

 The manual switch-off function via the microphone key can be deactivated (see page 171).

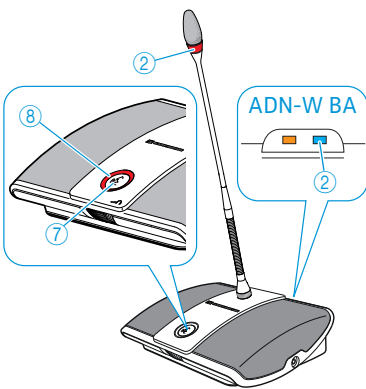

To **completely switch off** a wireless conference unit and to disconnect it from the power supply:

- ▶ If necessary, pull out the mains plug of the NT 12-50C power supply from the wall socket.
- ▶ Remove the ADN-W BA battery pack from the conference unit (see page 47).

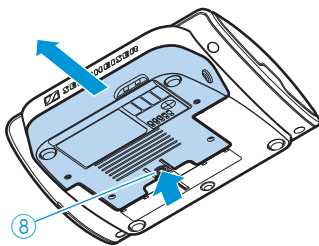

Using the media control system

To integrate the conference system into a media control system, make sure that the following requirements are met:

- The media control system is capable of sending and receiving ASCII control commands.
- The conference system and the media control system are interconnected via an Ethernet network.
- The network communication is not blocked (for example by a firewall).

Connecting the media control system

To connect the central unit to a media control system:

- ▶ Use a network cable (Cat5) to connect the Ethernet socket ⑫ of the central unit to the network interface of your media control system.

i You can also connect the media control system and the central unit using a switch or similar.

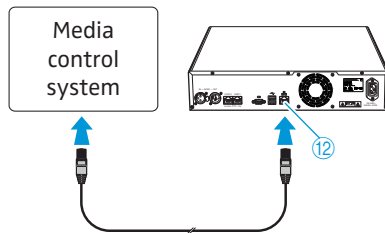

Connecting the media control system to the central unit

To enable communication between the central unit and the media control system:

- ▶ Make sure that the network communication between the central unit and the media control system is not blocked by a proxy server and/or a firewall. Port 53252 is used for communication.
- ▶ Connect the media control system to the central unit via the IP address of the central unit. The central unit serves as a socket server and communicates with the media control system via TCP and port 53252. For more information on setting the IP address of the central unit, refer to the following chapters:
 - “Adjusting network settings – “Network” submenu” on page 113
 - “Adjusting the network settings” on page 131
 - “Adjusting network settings” on page 153

Programming the media control system

Depending on the media control system used, you can individually program the graphical interface and the operating sequences and adapt them to your requirements.

You can find all information on the control commands and output instructions of the conference system for programming the media control system in the PDF document “ADN_MediaCtrl_Protocol.pdf” included on the DVD-ROM (supplied with the central unit) or at www.sennheiser.com.

For more questions on the integration of the ADN conference system into a media control system, contact your Sennheiser partner.

Configuring the wireless components

CAUTION

Risk of violation of legal requirements!

If you are using radio frequencies and transmission powers that cannot be used license-free in your country, there is a risk of violation of legal requirements.

- ▶ Use only radio frequencies and transmission powers that are approved and legal in your country.
- ▶ Under **"Country"**, select the correct country/region in which the conference system is to be used (see page 95 or page 160).

For wireless conferencing, you have to configure the wireless components in order to adapt the radio settings to the legal requirements of your country and to the requirements of your conference.

For configuring the wireless components, you can either use the central unit's operating menu or the "Conference Manager" software. However, the full functionality of a wireless conference system can only be configured using the software in Live operating mode.



In some countries/regions (e.g. Canada), the use of wireless components operating in the 5.15 to 5.25 GHz frequency band (channel 5 to 8) is restricted to indoor use.

Adjusting the radio settings

1. Select the country/region in which the conference system is to be used (**"Country"**, see page 95 or page 160).
The conference system only uses the radio settings that are approved and legal in the selected country/region.
2. Select dynamic frequency management (**"Channel Selection - Automatic"**, see page 96 or page 161).
All radio settings are made automatically. The conference system automatically detects occupied frequencies and switches to an unused frequency band in case of interference.
3. Select the access mode for the wireless conference units:
 - **Open access mode** (**"Access mode - Open"**, see page 96 or page 166)
All ADN-W D1 wireless conference units that are ready for operation automatically connect to the antenna module and can be used instantly. This access mode should be used if only one wireless conference system is in use and if the default eavesdropping protection is sufficient.
 - **Closed access mode** (**"Access Mode - Closed"**, see page 167)
Only wireless conference units whose serial numbers are listed in a participant list can be used in the wireless conference. If several wireless conferences are held simultaneously, the closed access mode ensures that the wireless conference units connect to the correct conference system. This access mode increases the protection against eavesdropping because only selected and enabled wireless conference units can be used.

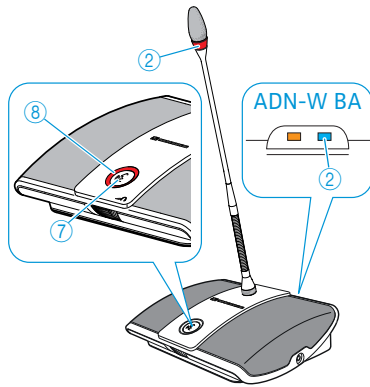

Checking the RF signal quality

During operation, you can check the RF signal quality of a wireless conference unit via the RF status indicator of the respective conference unit or via the “Conference Manager” software (see also “Reducing transmission interference” on page 82).

- The RF status indicator ② on the ADN-W BA battery pack provides information on the transmission quality directly at the wireless conference unit:

Status LED	Color	Meaning
RF status indicator ②	–	Good transmission quality
	blue, flashing slowly	Transmission quality is temporarily reduced
	blue, flashing rapidly	Transmission quality is permanently reduced



- The “Conference Manager” software allows you to check the RF signal quality in “Live” operating mode. Information on the RF signal quality is provided in both the Room View window and the Delegate View window (see page 208).

“RF status” icon (RF signal quality)	Meaning
green	The RF signal is of good quality, RF transmission is interference-free (RF signal quality is approx. 80–100%)
yellow	The RF signal is of sufficient quality, RF transmission can be subject to minimal interference (RF signal quality is approx. 20–80%)
red	The RF signal is of bad quality, interference and dropouts occur (RF signal quality is <20%)
gray	No information provided on the RF signal quality (e.g. in “Setup” operating mode without active connection to the central unit)

Reducing transmission interference

If you are using dynamic frequency management, the conference system automatically reacts to interference so that you don’t have to take any measures.

If you have manually selected the RF frequency, you have to take measures to try and reduce RF interference.

- Temporary interference

Temporary interference can be caused e.g. by persons walking through the transmission path between the antenna module and the wireless conference unit. Mobile phones and other RF equipment can also cause temporary interference. In general, the conference system compensates for this interference so that you don’t have to take measures.
- Permanent interference

Permanent interference can occur in the border area of the transmission range or can be caused by permanent radio installations (e.g. radio masts).



To reduce RF interference:

- ▶ Reduce the distance between antenna module and wireless conference unit (transmission range is max. 30 m in free line of sight).
- ▶ If possible, switch off interfering RF equipment.
- ▶ Use dynamic frequency management in order to avoid RF interference (see page 96 or page 161).





Using the central unit

Deactivating the lock mode of the central unit

If the lock mode is activated (see page 114), you have to deactivate it in order to be able to operate the central unit:

-  ▶ Press the jog dial or any other key.
"Lock" appears on the display panel.
-  ▶ Turn the jog dial.
The "Off" setting is selected.
-  ▶ Press the jog dial.
The lock mode is deactivated.

Functions of the keys

Action	Functions
Press the ESC key 	<ul style="list-style-type: none"> • Cancels the entry and returns to the next higher menu level or to the standard display
Press the jog dial 	<ul style="list-style-type: none"> • Changes from the standard display to the operating menu • Calls up a menu item • Enters a submenu • Stores the settings and returns to the operating menu
Turn the jog dial 	<ul style="list-style-type: none"> • Increases or reduces the floor channel volume (when the standard display is shown) • Changes to the next/previous menu item • Changes the setting of a menu item
Press the standard display key 	<ul style="list-style-type: none"> • Returns to the standard display



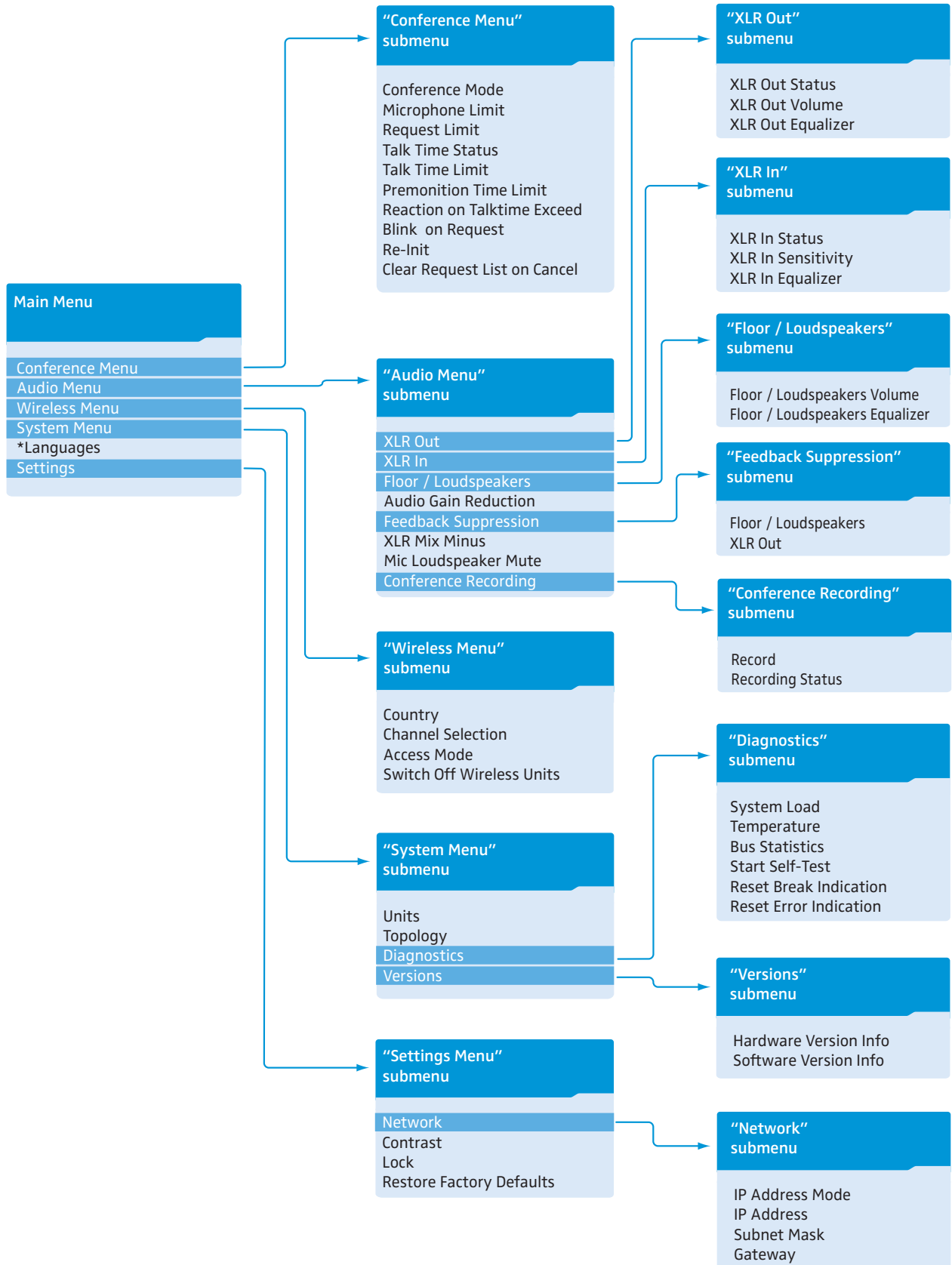

Configuring the conference system via the central unit

Overview of the operating menu

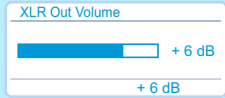
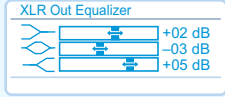
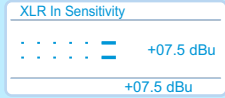
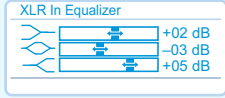
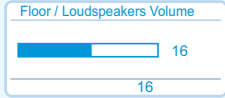
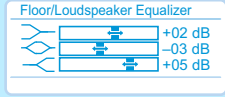

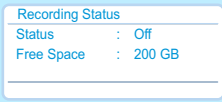
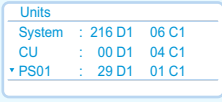
Display	Function of the menu item	Option/display	page
"Main Menu"			
"Conference Menu"	Calls up the "Conference Menu" submenu	–	90
"Audio Menu"	Calls up the "Audio Menu" submenu	–	97
"Wireless Menu"	Calls up the "Wireless Menu" submenu	–	95
"System Menu"	Calls up the "System Menu" submenu	–	102
"*Languages"	Adjusts the language	"German", "English", "Español", ...	113
"Settings Menu"	Calls up the "Settings" submenu	–	113
"Conference Menu"			
"Conference Mode"	Adjusts the conference mode	"Direct Access", "Override", "Push to talk" or "Request"	90
"Microphone Limit"	Sets the maximum number of speakers who can take the floor simultaneously for all conference modes	"1" ... "10"	91
"Request Limit"	Sets the maximum number of requests to speak for "Request" and "Direct Access" mode	"0" ... "10"	91
"Talk Time Status"	Activates/deactivates the speaking time limit	"On"/"Off"	92
"Talk Time Limit"	Sets the speaking time limit	"01" ... "60" in steps of 1 minute	92
"Premonition Time Limit"	Sets the advance warning time (warns speakers that they are approaching the end of the individual speaking time)	"00" ... "120" in steps of 10 seconds	92
"Reaction on Talktime Exceed"	Determines the behavior when the individual speaking time is exceeded	"Continue"/"Cancel"	93
"Blink on Request"	Activates/deactivates the flashing of the signal light ring when a request to speak is made	"On"/"Off"	93
"Re-Init"	Re-initializes the conference units	"Yes"/"No"	94
"Clear Request List on Cancel"	Sets the function of the priority key  of the chairperson unit	"On"/"Off"	94
"Audio Menu"			
"XLR Out"	Calls up the "XLR Out" submenu	–	97
"XLR In"	Calls up the "XLR In" submenu	–	
"Floor / Loudspeakers"	Calls up the "Floor / Loudspeakers" submenu	–	98
"Audio Gain Reduction"	The sum signal of all active conference units is output via the floor channel ("Floor / Loudspeakers"). The "Audio Gain Reduction" menu item allows you to adjust how the volume levels of the signals of the individual conference units are processed.	"0.0 dB per Mic." ... "–3.0 dB per Mic.", "Linear Division"	98
"Feedback Suppression"	Calls up the "Feedback Suppression" submenu	–	99
"XLR Mix Minus"	Activates the filtering of the IN audio input from the OUT audio output in order to avoid, for example, double audio signals during teleconferencing	"On"/"Off"	100
"Mic Loudspeaker Mute"	Deactivates the conference units' built-in loudspeakers for contributions coming from the conference units' microphones	"On"/"Off"	100

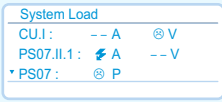
Display	Function of the menu item	Option/display	page
"Conference Recording"	Calls up the "Conference Recording" submenu	–	101
"XLR Out" menu			
"XLR Out Status"	Activates/deactivates the OUT audio output	"On"/"Off"	97
"XLR Out Volume"	Adjusts the volume of the XLR output	 "01" ... "32"	
"XLR Out Equalizer"	Adjusts the tone color of the XLR output	 "-12 dB" ... "+12 dB"	
"XLR In" menu			
"XLR In Status"	Activates/deactivates the IN audio input	"On"/"Off"	97
"XLR In Sensitivity"	Adjusts the sensitivity of the XLR input	 "-18.0 dBu" ... "+18.0 dBu"	
"XLR In Equalizer"	Adjusts the tone color of the XLR input	 "-12 dB" ... "+12 dB"	
"Floor / Loudspeakers" menu			
"Floor / Loudspeakers Volume"	Adjusts the floor channel volume ("Floor / Loudspeakers")	 "00" ... "32"	98
"Floor / Loudspeakers Equalizer"	Adjusts the tone color of the floor channel	 "-12 dB" ... "+12 dB"	
"Feedback Suppression" menu			
"Floor / Loudspeakers"	Changes the volume adjustment of the conference units' built-in loudspeakers in order to increase the max. possible volume while the risk of feedback due to the increased volume is reduced.	"Off" low (approx. +2 to +3 dB) "Low Intensity"	99
"XLR Out"	Changes the volume adjustment of the OUT audio output in order to increase the max. possible volume while the risk of feedback due to the increased volume is reduced.	high (approx. +5 to +6 dB) "High Intensity"	

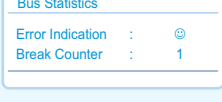
Display	Function of the menu item	Option/display	page
“Conference Recording” menu			
“Record”	Starts/stops the audio recording of the conference channels on a USB mass storage device	“On”/“Off”	101
“Recording Status”	Provides information on the status of the audio recording and on the available memory space on the USB mass storage device		
“Wireless Menu”			
“Country”	Country/area settings for radio communication	“Europa”, “USA/Canada”, “Mexico”, ...	95
“Channel Selection”	Adjusts the channel selection mode	“Automatic”/“Manual”	96
“Access Mode”	Adjusts the connection mode for wireless conference units	“Open”/“Closed”	96
“Switch Off Wireless Units”	Switches off all connected wireless conference units	“Yes”/“No”	96
“System Menu”			
“Units”	Displays the type and number of the conference units connected to the ADN CU1 central unit or ADN PS power supplies or connected wirelessly to an ADN-W AM antenna module		105
“Topology”	Displays the type of topology connected to the ADN PS power supplies (simple cabling ↔ or redundant ring topology ↻)		106
“Diagnostics”	Calls up the “Diagnostics” submenu	–	107
“Versions”	Calls up the “Versions” submenu	–	111
“Diagnostics” menu			
“System Load”	Provides information on the current supply (A), voltage supply (V) and power (P)		107
“Temperature”	Provides information on the temperature status		108
“Bus Statistics”	Provides information on the status of data transmission/errors		109
“Start Self-Test”	Performs a self-test on the conference system	“Yes”/“No”	110
“Reset Break Indication”	Resets the error counter (“Break Counter”) in the “Bus Statistics” menu item	“Yes”/“No”	110
“Reset Error Indication”	Resets the display for data bus errors (“Error Indication”) in the “Bus Statistics” menu item	“Yes”/“No”	111

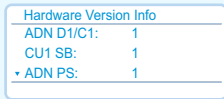
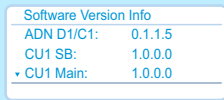
Display	Function of the menu item	Option/display	page
“Versions” menu			
“Hardware Version Info”	Displays the hardware version		111
“Software Version Info”	Displays the software version		112
“Settings” menu			
“Network”	Calls up the “Network” submenu	–	113
“Contrast”	Adjusts the contrast of the display panel	“1” ... “15”	114
“Lock”	Activates/deactivates the lock mode	“On”/“Off”	114
“Restore Factory Defaults”	Restores the factory default settings	“Yes”/“No”	114
“Network” menu			
“IP Address Mode”	Sets the IP address allocation mode	“Static IP”/“Dynamic IP”	113
“IP Address”	Sets the IP address of the central unit	“xxx . xxx . xxx . xxx”	113
“Subnet Mask”	Sets the subnet mask of the central unit	“xxx . xxx . xxx . xxx”	114
“Gateway”	Sets the IP address of a standard gateway	“xxx . xxx . xxx . xxx”	114

Working with the operating menu

By way of example of the “Microphone Limit” menu item, this section describes how to use the operating menu.

Information on the factory default settings of the operating menu can be found in the appendix (see page 253).

Changing from the standard display to the operating menu

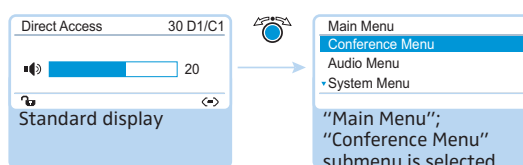

- ▶ Press the jog dial.
The standard display is replaced by the “Main Menu”. The last called-up submenu or the last called-up menu item is highlighted.

Calling up a menu item

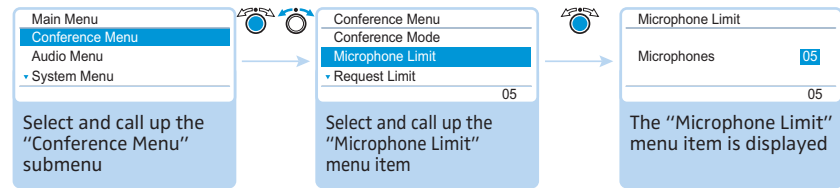

- ▶ Press the jog dial to call up the "Conference Menu" menu item. The "Conference Menu" submenu appears.
- ▶ Turn the jog dial to select the "Microphone Limit" menu item.
- ▶ Press the jog dial to call up the "Microphone Limit" menu item.

Changing and storing settings

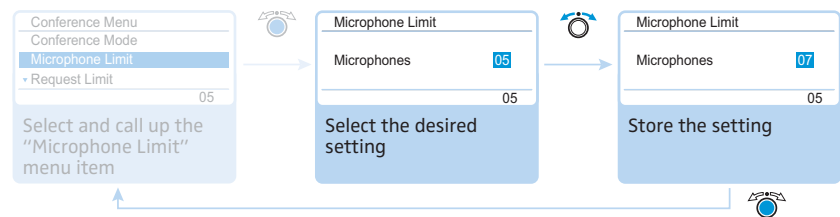

- ▶ Turn the jog dial to adjust settings in the "Microphone Limit" menu item.
- ▶ Press the jog dial. Your setting is stored. You are back to the operating menu.

i By briefly turning the jog dial to the left or right, the next or the previous menu item or setting is displayed.

If you turn the jog dial to the left or right and hold it in this position, the menu items or settings change in quick succession ("fast search" function).

Canceling an entry

- ▶ Press the **ESC** key. The operating menu or the next higher menu level appears.

Or:

- ▶ Press the standard display key. The standard display appears.

To subsequently directly return to the last edited menu item:

- ▶ Press the jog dial repeatedly until the last edited menu item appears.

Exiting the operating menu

- ▶ Press the standard display key. The standard display appears.

Or:

- ▶ Press the **ESC** key repeatedly until the standard display appears.

Adjusting the conference settings – “Conference Menu”

The settings available in the “Conference Menu” menu item affect the behavior of the entire conference system during a conference.

CAUTION

Interruption of a running conference!

If you adjust settings in the “Conference Menu” menu item during a running conference, the conference will be interrupted.

- ▶ Inform the participants that the conference settings are being changed and that they might have to make a new request to speak.

Setting the conference mode – “Conference Mode”

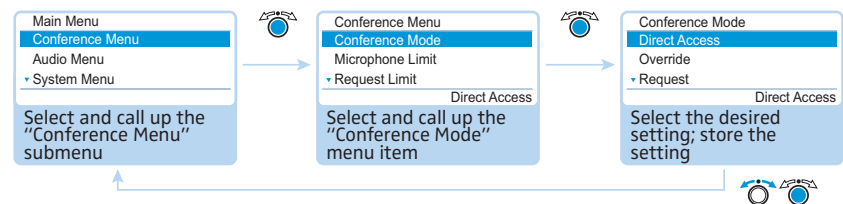

Possible settings: “Direct Access”, “Override”, “Push to talk” and “Request”

- “Direct Access” mode and “Override” mode:

These two conference modes do not require the use of a chairperson unit.

If the maximum number of speakers who can take the floor simultaneously (“Microphone Limit”) has not been reached, a further speaker can take the floor immediately.

Situation	The maximum number of speakers who can take the floor simultaneously (“Microphone Limit”) has been reached.
Event	A further speaker presses the microphone key on his or her conference unit.
Behavior	In “Direct Access” mode: The speaker has to wait until one of the current speakers passes on or loses his or her speaking privileges. He or she is then automatically granted speaking privileges. In “Override” mode: The speaker can take the floor immediately. The speaker with the longest speaking time loses his or her speaking privileges.

- “Push to talk” mode:

This conference mode does not require the use of a chairperson unit.

If the maximum number of speakers who can take the floor simultaneously (“Microphone Limit”) has not been reached, any speaker can take the floor immediately as soon as he or she presses and holds the microphone key. Releasing the microphone key will discontinue the speaking privileges.

Situation	The maximum number of speakers who can take the floor simultaneously (“Microphone Limit”) has been reached.
Event	A further speaker presses and holds the microphone key on his or her conference unit.
Behavior	Pressing and holding the microphone key causes no reaction. The speaker can only take the floor if the maximum number of speakers who can take the floor simultaneously drops below the specified limit value.

- “Request” mode:

For this mode to function, a chairperson unit is required or the conference system must be controlled via the “Conference Manager” software.

In “Request” mode, the chairperson receives requests to speak and grants speaking privileges according to the FIFO principle (First In – First Out), i.e. the speaker with the longest waiting time is granted speaking privileges.

Situation	The maximum number of requests to speak has been reached (“Request Limit”).
Event	A further speaker makes a request to speak.
Behavior	The speaker can only make a request to speak if the maximum number of requests to speak drops below the specified limit value.

Setting the max. number of speakers who can take the floor simultaneously – “Microphone Limit”

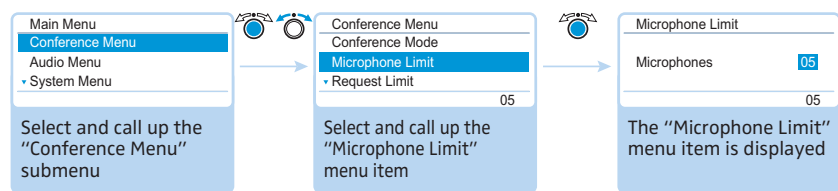

Adjustment range: “1” ... “10”

The “Microphone Limit” menu item allows you to set the max. number of speakers who can take the floor simultaneously for all conference modes.

The “Microphone Limit” menu item allows you to set the max. number of speakers who can take the floor simultaneously for all conference modes. Please note that any connected ADN C1 or ADN-W C1 chairperson unit is counted against the microphone limit (the number of chairperson units is limited to 10 max., see page 28). If you set a higher value (adjustment range “1” ... “10”) than the one determined by the number of connected chairperson units, the system will reduce the microphone limit to the maximum possible value (see examples in the table).

Chairperson units	Possible “Microphone Limit” values	Possible number of active delegate units
0	“1” - “10”	1-10
4	“1” - “6”	1-6
10	“0”	0; the delegate units can only reproduce contributions made via the chairperson units.

For information on how this setting affects your conference, refer to the section “Setting the conference mode – “Conference Mode”” on page 90.

Setting the maximum number of requests to speak – “Request Limit”

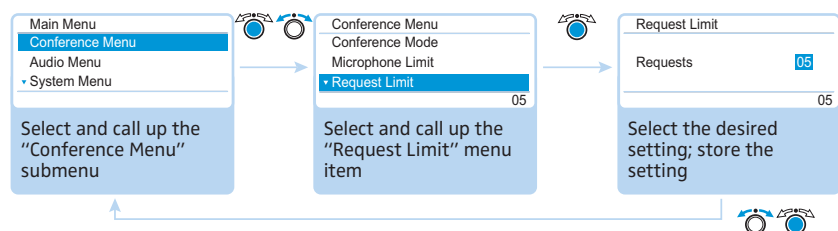

Adjustment range: “0” ... “10”

The setting adjusted in the “Request Limit” menu item becomes effective only if you are using a chairperson unit (“Request” mode) or if you have selected “Direct Access” mode.

For information on how this setting affects your conference, refer to the section “Setting the conference mode – “Conference Mode”” on page 90.

Activating/deactivating the speaking time limit – “Talk Time Status”

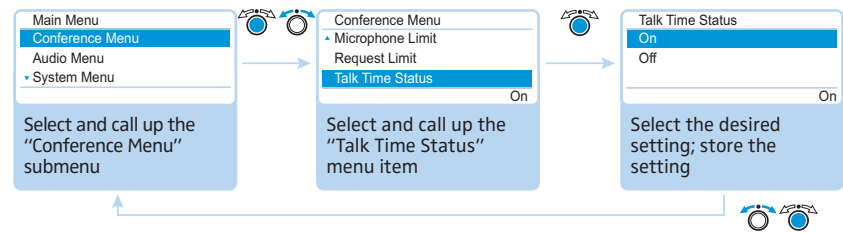

Possible settings: “On” and “Off”

This menu item allows you to activate/deactivate the speaking time limit. The duration of the speaking time limit, the advance warning time, and the behavior after expiration of the speaking time limit can be set in the following 3 menu items (“Talk Time Limit”, “Premonition Time Limit” and “Reaction on Talktime Exceed”).

Setting the speaking time limit– “Talk Time Limit”

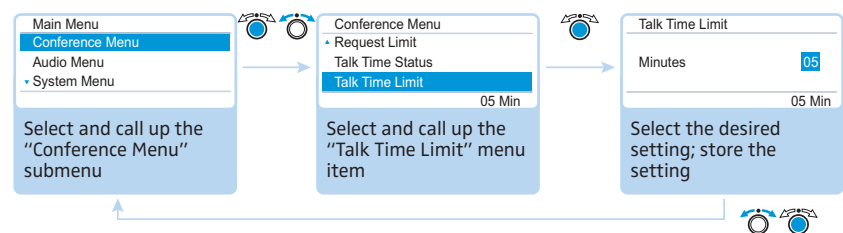

Adjustment range: “01” ... “60”, adjustable in steps of 1 minute

The speaking time limit becomes effective only if it is activated in the “Talk Time Status” menu item (see previous section).

Please note that the speaking time limit applies to each and every input to the discussion.

Setting the advance warning time – “Premonition Time Limit”

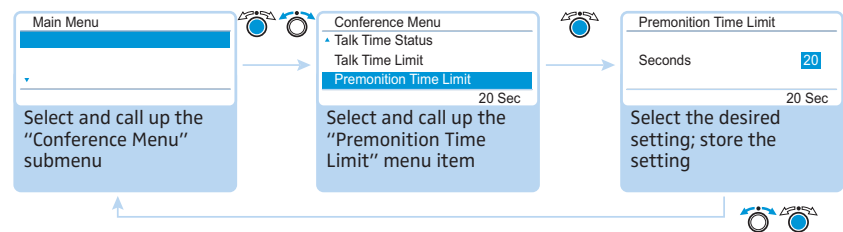

Adjustment range: “00” ... “120”, adjustable in steps of 10 seconds

- ▶ Set the advance warning time. This setting affects your conference as follows (example):

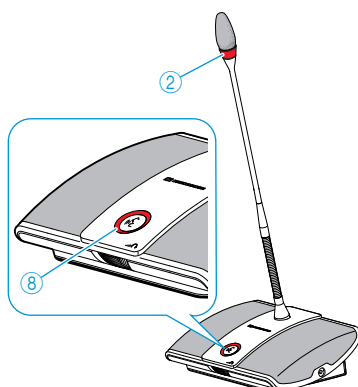

“Talk Time Limit” (speaking time limit)	15 (minutes)
“Premonition Time Limit” (advance warning time)	60 (minutes)
Effect	60 seconds before the speaking time limit expires, i.e. after 14 minutes in this example, the signal light ring ② and the microphone LED ⑧ start flashing red.

Determining the behavior when the individual speaking time is exceeded – “Reaction on Talktime Exceed”

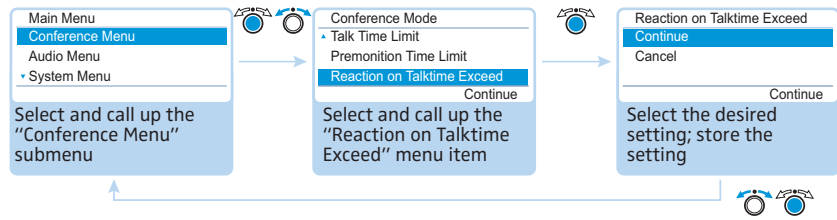

Possible settings: “Continue” and “Cancel”

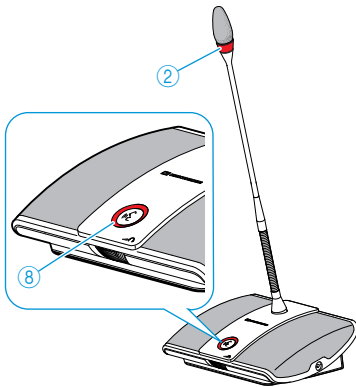

Event	The end of the individual speaking time is reached.
Behavior	<p>“Continue”: The individual speaking time is continued. The signal light ring ② and the microphone LED ⑧ flash red until the speaker has finished speaking.</p> <p>“Cancel”: The individual speaking time is terminated. The signal light ring ② and the microphone LED ⑧ go off.</p>

Activating/deactivating the flashing of the signal light ring when a request to speak is made – “Blink on Request”

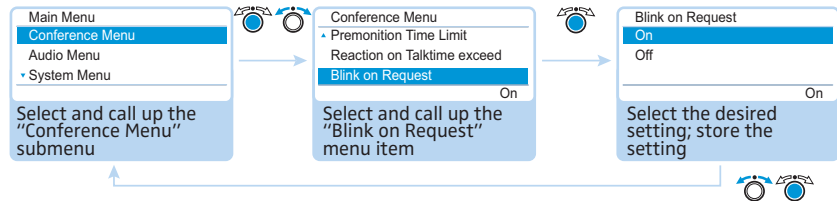

Possible settings: “On” and “Off”

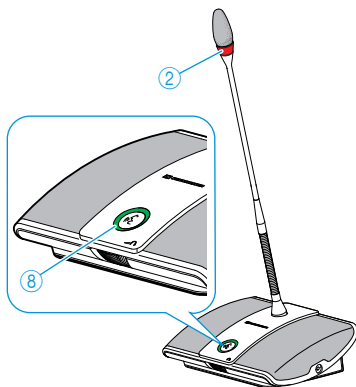

Setting	Behavior of the signal light ring
“On”	When a participant makes a request to speak, the microphone LED ⑧ flashes green and the signal light ring ② flashes red. The participant him or herself sees the flashing microphone LED ⑧ whereas the other participants see the flashing signal light ring ② which indicates that a request to speak has been made.
“Off”	When a participant makes a request to speak, the microphone LED ⑧ flashes green. All other participants cannot see that this participant has made a request to speak.

Re-initializing the conference units – “Re-Init”

If you connect ADN C1 or ADN-W C1 chairperson units to the conference system during a running conference, you have to re-initialize them.

When conference units are re-initialized, the conference will be interrupted. An audio recording on a USB mass storage device will not be stopped.

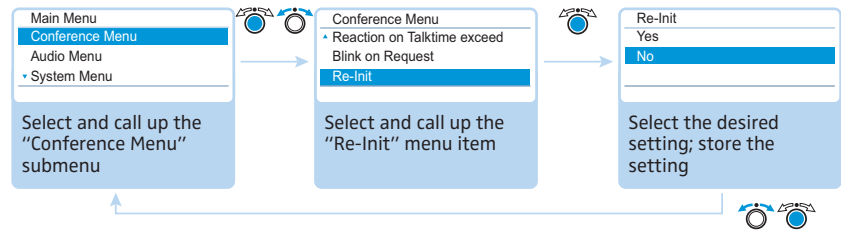

Possible settings: “Yes” and “No”

Setting the function of the priority key ④ – “Clear Request List on Cancel”

This menu item allows you to set the function of the priority key ④ of the ADN C1 or ADN-W C1 chairperson unit.

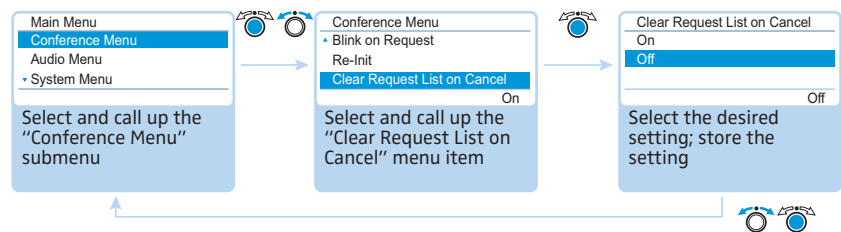
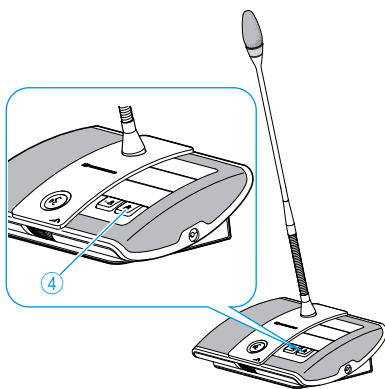

Possible settings: “On” and “Off”

Setting	Function of the priority key
“On”	Pressing the priority key ④ deactivates all ADN D1 or ADN-W D1 delegate units. All requests to speak are deleted.
“Off”	Pressing the priority key ④ deactivates all currently active ADN D1 or ADN-W D1 delegate units. All requests to speak are retained.

Adjusting the radio settings – “Wireless Menu”

The operating menu allows you to configure the basic functions of a wireless conference system. However, in order to be able to configure and use the full functionality of a wireless conference system and to monitor a wireless conference system, you have to use the “Conference Manager” software (see page 160).

i For wireless conferencing, the settings “Channel Selection - Manual” and “Output Power” are saved directly in the connected ADN-W AM antenna module. These settings are not saved in a configuration file of the “Conference Manager” software. If you replace the antenna module, you will have to specify these settings again.

Adjusting the country/area settings for radio communication – “Country”

CAUTION

Risk of violation of legal requirements!

If you are using radio frequencies and transmission powers that cannot be used license-free in your country, there is a risk of violation of legal requirements.

- ▶ Use only radio frequencies and transmission powers that are approved and legal in your country.
- ▶ Under “Country”, select the correct country/region in which the conference system is to be used.

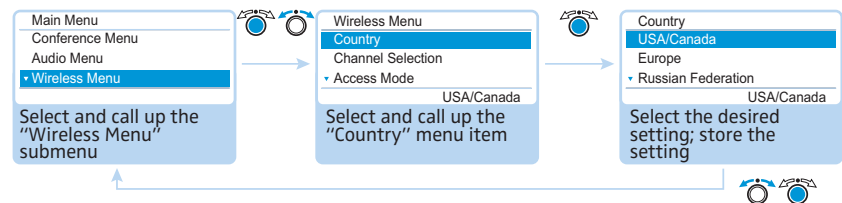

Possible settings: “Europe”, “USA/Canada” [factory default], “Mexico”, “Japan”, “People’s Republic of China”, “Russian Federation”, “Turkey”, “Australia & New Zealand”, “United Arab Emirates”

Select the country/region in which the conference system is to be used. The conference system then only uses frequencies and transmission powers that are approved and legal in the selected country/region.

i In some countries/regions (e.g. Canada), the use of wireless components operating in the 5.15 to 5.25 GHz frequency band (channel 5 to 8) is restricted to indoor use.

i The country-specific settings for the United States of America and Canada, “USA/Canada”, are the most restrictive radio settings of the conference system. These settings are the factory defaults.

If you are using the ADN-W AM-US antenna module that is designed for the North American market, you cannot change the country-specific settings. The conference system only uses frequencies and transmission powers that are approved for the North American market and all other regions.

Adjusting the channel selection mode – “Channel Selection”

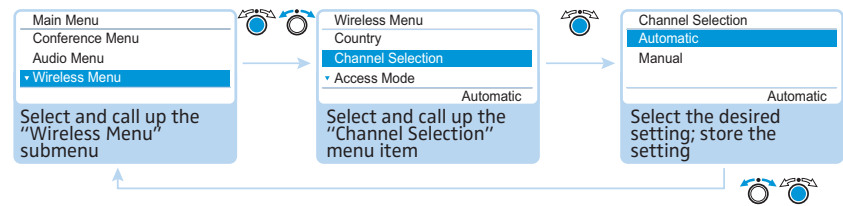

Possible settings: “Automatic” and “Manual”

Setting	Frequencies used by the wireless components
“Automatic”	The conference system automatically selects the frequencies and switches to unused frequencies in case of interference (dynamic frequency management).
“Manual”	The conference system uses a manually selected frequency. This setting can only be configured via the “Conference Manager” software (see page 162).

Adjusting the connection mode for wireless conference units – “Access Mode”

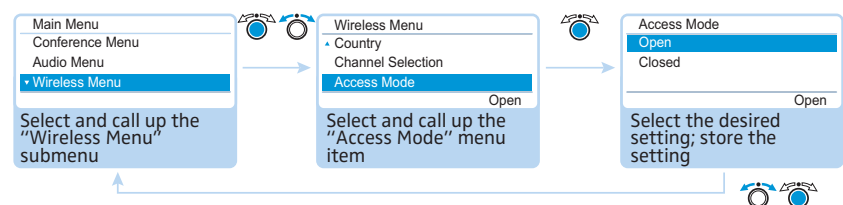

Possible settings: “Open” and “Closed”

Setting	Connection mode used to connect to the antenna module
“Open”	All wireless conference units within the transmission range automatically connect to the antenna module and can be used in the wireless conference.
“Closed”	The wireless conference units have to be manually logged in to the antenna module via the “Conference Manager” software (see page 167). Only wireless conference units whose serial numbers are listed in a participant list can be used in the wireless conference. Use this function if several wireless conferences are held simultaneously or if you run a closed conference.

Switching off all connected wireless conference units – “Switch Off Wireless Units”

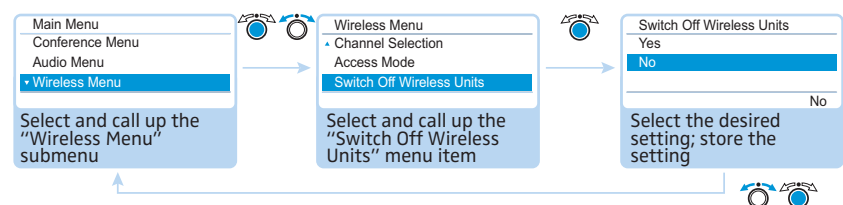

Possible settings: “Yes” and “No”

This function allows you to switch off all wireless conference units that are wirelessly connected to the conference system.

Adjusting the audio settings – “Audio Menu”

The “Audio Menu” submenu allows you to adjust settings that affect the audio signals of the conference system.

Adjusting settings for the OUT audio output and the IN audio input – “XLR Out” and “XLR In”

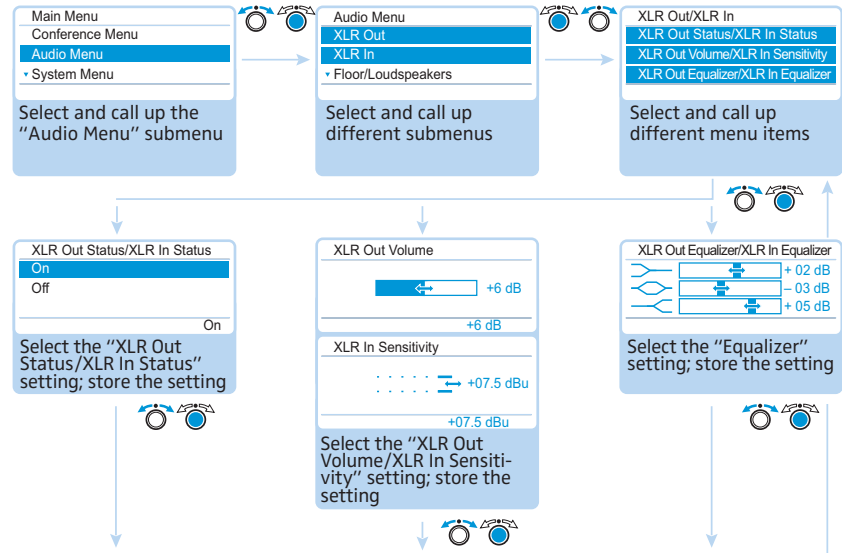

Submenu	Menu item	Function
“XLR Out”	“XLR Out Status”	Activates/deactivates the OUT audio output
	“XLR Out Volume”	Adjusts the volume of the OUT audio output
	“XLR Out Equalizer”	Adjusts the tone color
“XLR In”	“XLR In Status”	Activates/deactivates the IN audio input
	“XLR In Sensitivity”	Adjusts the sensitivity of the IN audio input (the current level is displayed). ▶ Adjust the sensitivity so that the level display shows an almost full deflection at maximum input volume.
	“XLR In Equalizer”	Adjusts the tone color

i In the “Equalizer” menu item, you can change between the frequency ranges by pressing the jog dial ④.

Press the **ESC** key ⑤ to cancel your entry and restore the previous state of all frequency ranges.

Adjusting settings for the floor channel – “Floor/Loudspeakers”

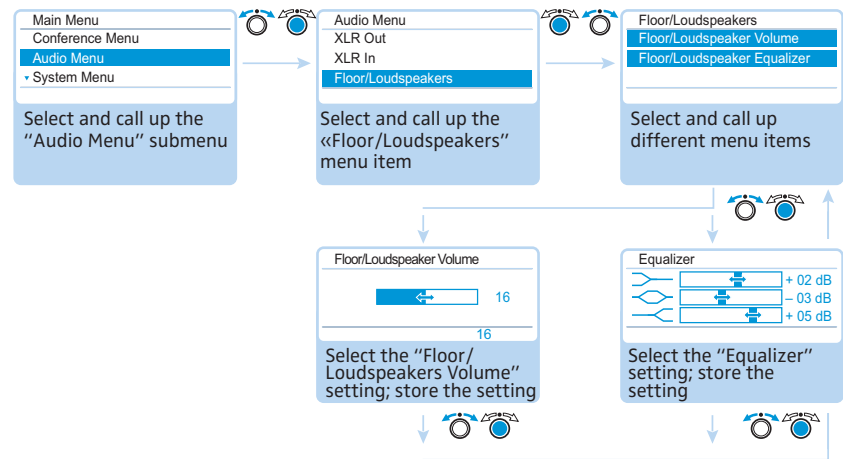

Menu item	Function
“Floor/Loudspeakers Volume”	Sets the floor channel volume
“Floor/Loudspeakers Equalizer”	Adjusts the tone color

i In the “Equalizer” menu item, you can change between the frequency ranges by pressing the jog dial.

Press the **ESC** key **5** to cancel your entry and restore the previous state of all frequency ranges.

Adjusting the processing of the conference units’ audio signals in the floor channel – “Audio Gain Reduction”

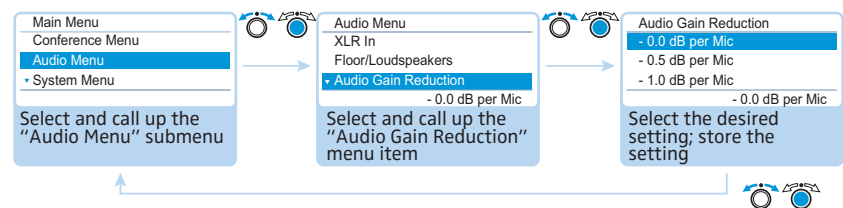

Possible settings: “0.0 dB per Mic” ... “-3.0 dB per Mic” and “Linear Division”

The sum of the audio signals of all conference units is fed to the floor channel (“Floor/Loudspeakers”) which in turn is output via the conference units’ built-in loudspeakers and via the **OUT** audio output. The volume level of the floor channel increases with each additional audio signal* and tends to overmodulate. The “Audio Gain Reduction” menu item allows you to adjust how the volume levels of the signals of the conference units are processed.

* conference units and **IN** audio input

Situation	The audio signal of the 1. conference unit is fed to the floor channel.
Event	The audio signal of another conference unit is fed to the floor channel. The volume level of the floor channel would increase if the signal wasn't influenced.
Behavior	<p>"0.0 dB per Mic" ... "-3.0 dB per Mic" setting: With each additional audio signal, the volume level of the floor channel is reduced by the adjusted value.</p> <ul style="list-style-type: none"> ▶ Try out the different settings by activating the maximum number of open channels (see page 116). The floor channel should be heard at the desired volume level without any distortion or feedback. ▶ First start with low values. <p>"Linear Division" setting: The volume level of the floor channel is automatically reduced depending on the number of conference units with speaking privileges (see the following table).</p>

Conference units with speaking privileges	1	2	3	4	5	6	7	8	9	10
Reduction of the volume level of the floor channel in dB	0	-6	-9	-12	-14	-16	-17	-18	-19	-20

Activating/deactivating the function for eliminating feedback and for increasing the volume – "Feedback Suppression"

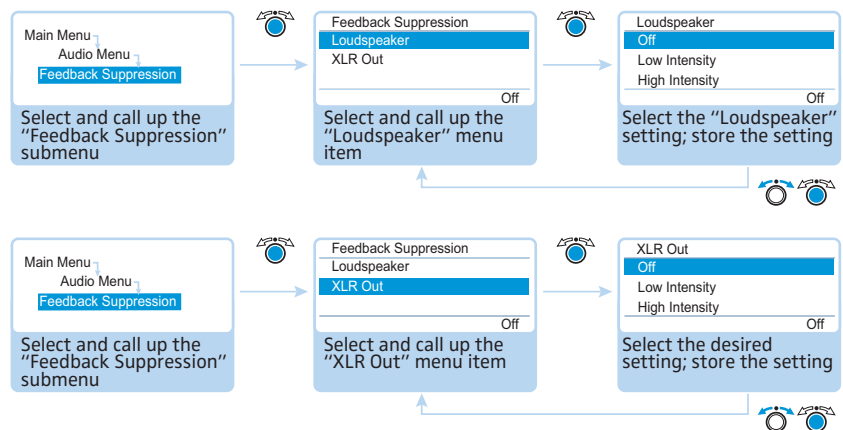

Submenu	Menu item	Function
"Feedback Suppression"	"Loudspeaker"	Adjusts the influence for the floor channel ("Floor/Loudspeakers")
	"XLR Out"	Adjusts the influence for the OUT audio output ("XLR Out")

Possible settings:

- “Off”: The function is deactivated.
- “Low Intensity”: The volume can be slightly increased (approx. +2 to +3 dB); feedback is reduced.
- “High Intensity”: The volume can be strongly increased (approx. +5 to +6 dB); feedback is reduced.

Via the “Feedback Suppression” submenu, you can change the volume adjustment of the floor channel (“Floor/Loudspeakers”) or the OUT audio output (“XLR Out”). The “Feedback Suppression” function allows you to increase the maximum possible volume while the risk of feedback due to the increased volume is reduced.

Activating/deactivating the filtering of the IN audio input from the OUT audio output (avoiding echoes) – “XLR Mix Minus”

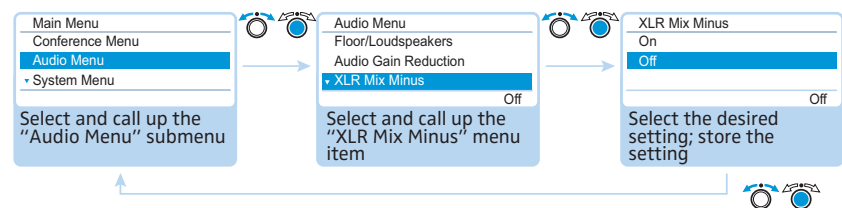

Possible settings: “On” and “Off”

The “XLR Mix Minus” function filters the audio signals of the IN audio input from the audio signals of the OUT audio output. This prevents that external conference participants, which are for example connected via a video- or teleconference, hear delayed or double audio signals.

A connected video- or teleconferencing system must also support this function.

Activating/deactivating the conference units’ built-in loudspeakers for contributions coming from the conference units’ microphones – “Mic Loudspeaker Mute”

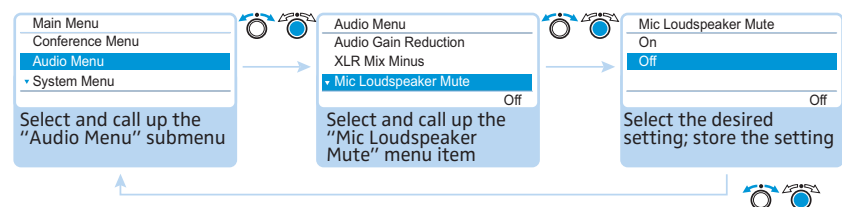

Possible settings: “On” and “Off”

The “Mic Loudspeaker Mute” function allows you to deactivate the conference units’ built-in loudspeakers and headphones sockets for contributions coming from the conference units’ microphones. Contributions are only output via the OUT output socket.

The conference units’ built-in loudspeakers only output audio signals that are fed in via the IN audio input (e.g. from a video- or teleconferencing system).

Activating/deactivating the recording of the conference on a USB mass storage device and viewing the status of the recording – “Conference Recording”

The “Conference Recording” submenu allows you to make settings concerning the audio recording of the conference on a connected USB mass storage device (see page 122).

Submenu	Menu item	Function
“Conference Recording”	“Record”	Activates/deactivates the recording of the conference on a USB mass storage device
	“Recording status”	Provides information on the status of the recording and on the available memory space on the USB mass storage device

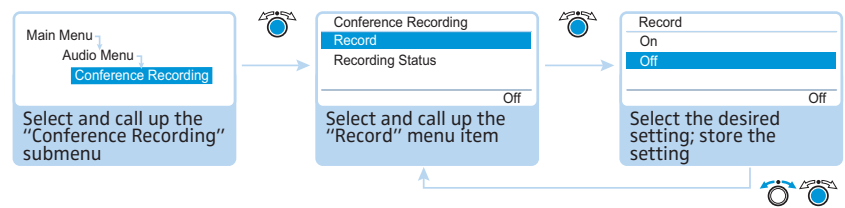

Possible settings: “On” and “Off”

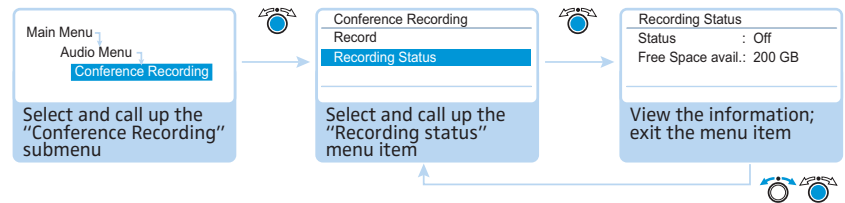





Checking the system and detecting errors – “System Menu”

The “System” submenu provides information on the current status of your conference system and any errors that have occurred.

After switch-on, the central unit automatically performs a self-test. If errors are detected during the self-test, the error icons 21 to 24 indicate the type of error encountered. When the error icons 23 and 24 appear, and severe errors have occurred, the display panel changes from orange to red. If severe cabling errors are detected during the self-test, an error message appears, the display panel lights up red and the conference system is not operational. For more information on severe cabling errors, refer to page 62 and page 67.

The central unit also checks the conference system for errors during a running conference and, if necessary, shows the following icons to indicate these errors.

Icon	Meaning
	Warning triangle
	Short-circuit icon
	Cable fault icon
	Structural change icon

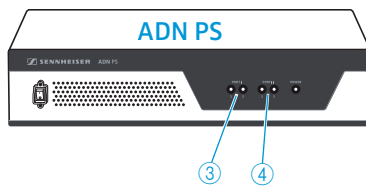
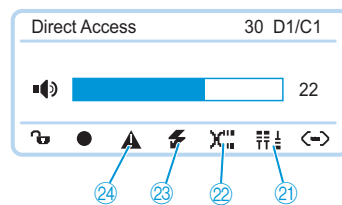

When the error icons 23 and 24 appear and the error concerns the PORT socket of an ADN PS power supply, the PORT status LED 3 or 4 of the affected ADN PS flashes orange.

 Status information and errors during wireless operation can be monitored using the “Conference Manager” software (see page 208).

To ensure trouble-free operation of your conference system:

- ▶ Carry out the following steps **before** starting the conference. This allows you to diagnose and remedy errors in your conference system at an early stage.
- ▶ Set up your entire conference system. If you do not yet know the final number of participants, take the largest possible number of participants as a starting point. Connect the corresponding number of conference units to the central unit.
- ▶ If applicable, switch on all wireless conference units so that they can connect to the antenna module.
- ▶ First switch on all ADN PS power supplies and then switch on the ADN CU1 central unit. The ADN CU1 central unit performs the self-test and also tests the cabling of the ADN PS power supplies as well as all wireless conference units that are connected to the antenna module.

 During the self-test, do not press any keys or buttons and do not change the set up of the conference system.

If the number of participants increases after an error-free self-test, we **strongly** recommend you to perform a new self-test **before** starting your conference.

If an error or a warning occurs, proceed as follows:

- ▶ Eliminate the error (see the following tables).

- ▶ After error elimination, perform a manual self-test by selecting “Yes” in the “Start Self-Test” menu item:

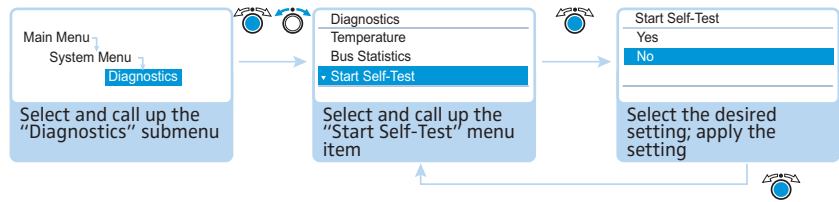

The central unit now checks if the reported error still occurs. If the error has been eliminated, the corresponding error icon will go off after the self-test.

The following tables show possible error indications and steps for error elimination.

<p>Display</p>		<p>Only the warning triangle 24 is displayed. The display panel lights up red.</p>
<p>Error and remedy</p>	<p>Several errors may have occurred.</p> <ul style="list-style-type: none"> ▶ Check the following menu items one after the other: <ul style="list-style-type: none"> – “System Load” (see page 107) – “Temperature” (see page 108) – “Bus Statistics”(see page 109) <p>If the menu items display errors, follow the options and/or steps for error elimination mentioned there.</p>	
<p>Display</p>		<p>Only the warning triangle 24 is displayed.</p>
<p>Error and remedy</p>	<p>The system provides information on the following hardware configurations:</p> <ul style="list-style-type: none"> • The conference system comprises more than 400 conference units. • The conference system comprises more than 150 ADN-W D1/ADN-W C1 wireless conference units. • The conference system comprises more than 15 ADN PS power supplies. Surplus power supplies are automatically deactivated. • More than one ADN-W AM antenna module is connected to the central unit. Surplus antenna modules are automatically deactivated. <ul style="list-style-type: none"> ▶ If necessary, reduce the number of connected components (such as conference units, power supplies, antenna modules). <p>If none of the described hardware configurations is present:</p> <ul style="list-style-type: none"> ▶ Check the “Hardware Version Info” menu item (see page 111), to see if the connected conference units have a different hardware version. 	

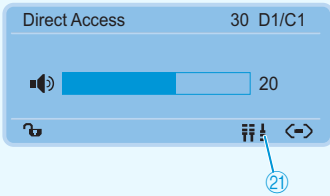
<p>Display</p>	 <p>Only the structural change icon ⑳ is displayed.</p>
<p>Error</p>	<p>Change in the number of conference units due to:</p> <ul style="list-style-type: none"> • manual adding or removal of one or several conference units • automatic resetting of one or several conference units (restart of the conference units) • switch-off of one or several conference units due to undervoltage • disconnection e.g. caused by <ul style="list-style-type: none"> – faulty plug connections – wire or cable faults
<p>Remedy</p>	<p>▶ Perform a manual self-test (see page 110). The display can change as follows:</p> <ul style="list-style-type: none"> – The structural change icon ⑳ disappears: The structural change has been detected, there are no errors. – The structural change icon ⑳ is still displayed: Follow the steps below. <p>If, after performing the self-test, the structural change icon ⑳ is still displayed:</p> <ul style="list-style-type: none"> ▶ Reset the error counter (“Break Counter”) (see page 110). ▶ Change to the “Bus Statistics” menu item (see page 109) and check the digit behind “Break Counter”. ▶ Carefully move the conference units and systems cables and check if the digit behind “Break Counter” is increased. If the digit is increased, check the corresponding plug connections or replace the corresponding conference units and system cables. <p>If the error still persists:</p> <ul style="list-style-type: none"> ▶ Follow the steps described in the “System Load” menu item (see page 107). ▶ Perform a manual self-test (see page 110).

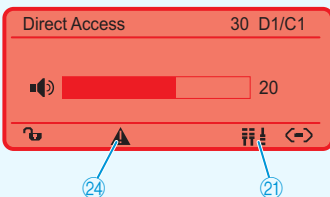
<p>Display</p>	 <p>The warning triangle ㉔ and the structural change icon ㉑ are displayed. The display panel lights up red.</p>
<p>Error and remedy</p>	<p>Change in the number of conference units during the self-test: After switch-on, an automatic self-test is performed which simulates a running conference with the connected conference units. If a failure of conference units occurs, the above mentioned error icons appear. A failure of conference units can be caused by undervoltages or overcurrents:</p> <ul style="list-style-type: none"> ▶ Follow the steps described in the “System Load” menu item (see page 107). ▶ Perform a manual self-test (see page 110).

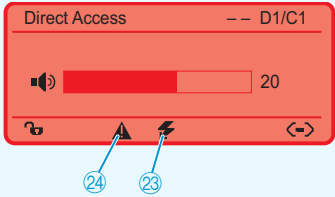
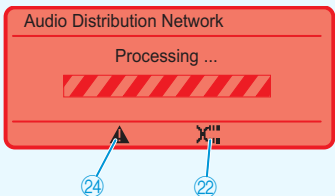
<p>Display</p>		<p>The warning triangle ②④ and the short-circuit icon ②③ are displayed. The “D1/C1” display displays no conference units (“--”). The display panel lights up red. The PORT status LED of the affected ADN PS power supply flashes orange.</p> <p>The corresponding connection socket PORT on the ADN CU1 central unit or on the ADN PS power supply is deactivated.</p>
<p>Error and remedy</p>	<p>Short-circuit caused by:</p> <ul style="list-style-type: none"> • metal parts (e.g. paper clips) that bridge the contacts of the plug connections • faulty system cables • wrong cables (e.g. crossover cables) <p>▶ Check if you are using the correct system cables.</p> <p>▶ Follow the steps described under the “System Load” menu item (see page 107).</p> <p>▶ Perform a manual self-test (see page 110).</p> <p>The “D1/C1” display displays the connected conference units (e.g. “08”), the previously deactivated connection socket PORT is activated again.</p>	
<p>Display</p>		<p>Only possible if the conference units are/the antenna module is directly connected to the ADN CU1 central unit.</p> <p>The warning triangle ②④ and the cable fault icon ②② are displayed and the “Processing...” bar appears. The display panel lights up red.</p>
<p>Error and remedy</p>	<p>The IN socket ⑩ and the OUT socket ⑪ on a conference unit have been accidentally swapped; the microphone LED ⑧ and the signal light ring ② of the affected conference unit flash red.</p> <p>▶ Check if the cables are connected correctly (see page 57).</p>	

Displaying the type and number of the connected conference units – “Units”

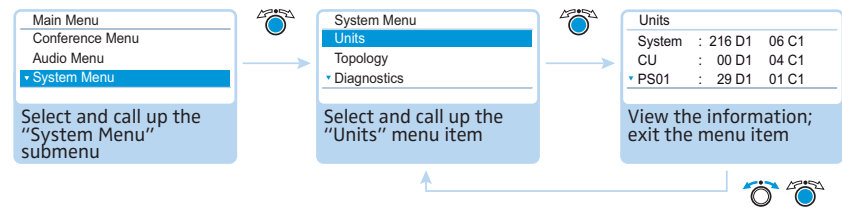

The “Units” menu item displays the number of all delegate units (“D1”) and chair-person units (“C1”) used in the conference system (“System”).

You can view how many conference units are connected to the PORT I (“CU.I”) and II (“CU.II”) sockets of the ADN CU1 central unit. If you are using at least one ADN PS, the number of conference units connected to the central unit (“CU”) and per power supply (e.g. “PS01”) is displayed.

Connected wireless conference units are displayed behind “System”.

Number of conference units marked with an asterisk“*”

Units	
System	: * 216 D1 * 06 C1
CU	: * 00 D1 * 04 C1
* PS01	: * 29 D1 * 01 C1

If the number of conference units is marked with an asterisk“*”, the conference system cannot determine the exact number of conference units and their connection to a specific ADN PS power supply. This happens when the topology has been changed (e.g. when conference units have been added to the conference system during operation).

To make the conference system determine the exact number of conference units and their connection to a specific ADN PS and to make the asterisk “*” disappear:

- ▶ Perform a manual [self-test](#) (see page 110).

Or:

- ▶ Switch the conference system on again (see page 77).

Displaying the topologies connected to the ADN PS power supplies – “Topology”

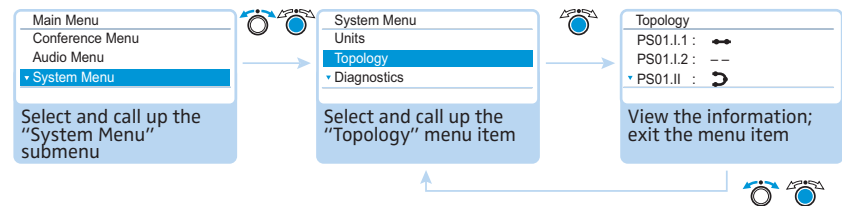

The “Topology” menu item displays – for all ADN PS power supplies used in the conference system – the connected topologies (simple cabling with cable strings or redundant ring topology).

In the case of simple cabling, the outputs 1 and 2 of the respective PORT socket are displayed (e.g. “PS01.1.1” for ADN PS power supply connected to the central unit at the first position, PORT I, output 1). In the case of redundant ring topology, only PORT I or II is displayed (e.g. “PS01.I”).

Display	Meaning
— —	Conference units are connected in a cable string to the PORT output
⤷	Conference units are connected in a cable ring to the PORT output
— —	No conference units are connected to the PORT output

System analysis – “Diagnostics” submenu

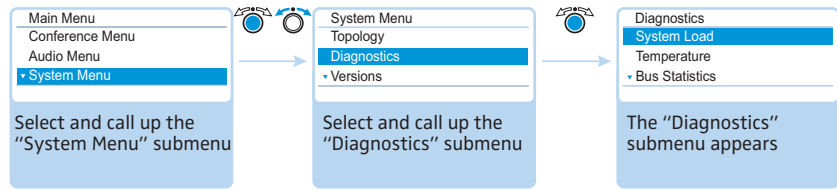

The “Diagnostics” menu item provides information on the status of the current and voltage supply and the power, on the status of data transmission and on interruptions due to faulty cables or cable connections.

Displaying status information on the current and voltage supply – “System Load”

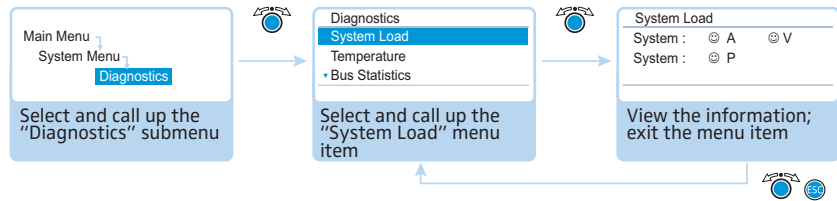

If, at all PORT sockets of the ADN CU1 central unit and the ADN PS power supplies, the system values for current (Ampere = “A”), voltage (Volt = “V”) and power (Power = “P”) are within the normal range, ☺ icons appear behind the corresponding “System” entry.

System Load		
System :	☺	P
CU.I :	--	A ☺ V
PS07.II.1 :	⚡	A -- V

If critical values occur at one of the PORT sockets of the ADN CU1 central unit or one of the ADN PS power supplies, ☹ icons appear behind the corresponding “System” entry and the affected components and their PORT sockets are listed.

Examples for the listing of affected components:

Display	Meaning
CU.I	ADN CU1 central unit, PORT I
PS07.II.1	ADN PS power supply connected to the central unit at the seventh position, PORT II, output 1

The following errors can occur at the PORT sockets or the components:

Display	Meaning and causes
A ☹	An overcurrent at one of the PORT sockets can be caused, among other things, by <ul style="list-style-type: none"> metal parts (e.g. paper clips) that bridge the contacts of the plug connections faulty conference units faulty system cables too long system cables too many conference units connected to a PORT socket
A ⚡	A short-circuit at one of the PORT sockets can be caused, among other things, by <ul style="list-style-type: none"> metal parts (e.g. paper clips) that bridge the contacts of the plug connections faulty conference units/faulty antenna module faulty system cables wrong cables (e.g. crossover cables)
V ☹	An undervoltage can be caused by <ul style="list-style-type: none"> faulty conference units/faulty antenna module too long system cables too many conference units connected to a PORT socket

Display	Meaning and causes
V --	The PORT socket is deactivated due to e.g. <ul style="list-style-type: none"> no conference units connected/faulty antenna module a short-circuit
P ☹	The power of the ADN CU1 central unit or ADN PS power supply is not sufficient because too many conference units are connected.
P --	Information on the power output of the ADN CU1 central unit or ADN PS power supply is not yet available.

If an error icon appears (see page 102), check your conference system for the errors mentioned above.

i If an error is detected **at startup** of the central unit, first eliminate the error and then perform a manual **self-test** (see page 110) to check if the error still persists.

If an error has only occurred **during operation** and has already been eliminated, this is automatically detected by the central unit.

Possible steps for error elimination:

- Eliminate the errors separately for the ADN CU1 central unit, the ADN PS power supplies and the respective affected PORT sockets.
- Calculate the maximum length of the cable string or cable ring (see page 29) and, if necessary, reduce the cable length.
- Reduce the number of conference units to 15-20 max. per cable string or ring.
- If necessary, further reduce the number of conference units until there are no errors reported.

Then add conference units one after the other and observe the central unit's display panel. If an error is reported, the cause of the error might be the last added conference unit, the cable used or metal parts that bridge the contacts of the plug connection.

Displaying the temperature status – "Temperature"

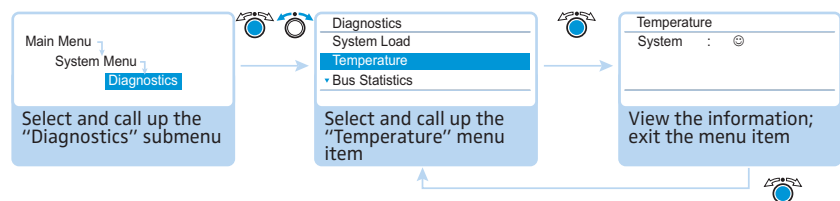

If the temperature of the ADN CU1 central unit and of the ADN PS power supplies is within the normal range, the ☺ icon appears behind "System".

If the temperature of the ADN CU1 central unit and the ADN PS power supplies exceeds the limit values, the ☹ icon appears behind "System" and the affected components are listed together with the ☹ icon below "System".

Temperature	
System	: ☹
CU	: ☹
PS07	: ☹

Examples for the listing of affected components:

Display	Meaning
CU	ADN CU1 central unit
PS07	ADN PS power supply connected to the central unit at the seventh position

To prevent an increase in temperature:

- ▶ Make sure that the air vents of the ADN CU1 central unit and the ADN PS power supplies are not covered or blocked (see page 38 and page 40).
- ▶ If necessary, clean the air vents (see page 225).

If the ADN CU1 central unit and the ADN PS power supplies are mounted into a rack:

- ▶ Provide additional ventilation by providing for a duct or vent space of 1 U below and above the central unit and the power supplies and/or by installing additional fans into the rack.

When the temperature is again within the permissible temperature range, this is automatically detected by the system (the ☺ icon appears behind "System" on the display). The temperature check is carried out cyclically.

If, in spite of these measures, the temperature is still detected to be too high, one of the fans might be faulty:

- ▶ Have the fans checked and, if necessary, replaced by qualified maintenance personnel.

Displaying system bus errors – "Bus Statistics"

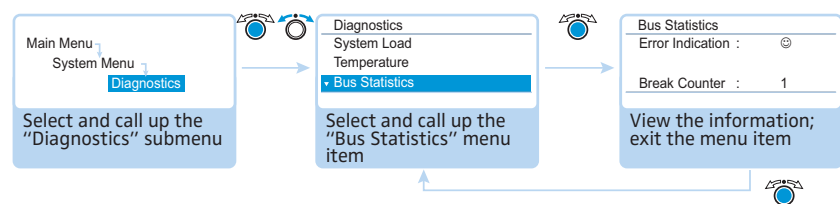

Possible causes for system bus errors are:

- changes in the number of conference units
- faulty cables
- faults in cable shields
- faulty conference units/faulty antenna module
- strong electromagnetic fields

If there are system bus errors, the ☹ icon appears behind "Error Indication". The display panel lights up red and the warning triangle ⚠ is displayed on the standard display (see page 102).

There are **temporary** or **permanent** transmission errors:

Temporary transmission errors can be caused by e.g. poorly shielded mobiles phones that are placed too close to the system cables, the conference units or the antenna module. If the transmission error no longer exists, the ☺ icon appears on the display. The display panel lights up orange and the warning triangle ⚠ goes off.

Permanent transmission errors must be eliminated immediately in order to ensure trouble-free operation of your conference system. Follow the steps for error elimination described under the "System Load" menu item (see page 107). If necessary, reduce the length of the system cables between the ADN CU1 central unit and the ADN PS power supplies (shorter cables increase the operational reliability, the maximum length allowed is 50 m). In addition, check if other electronic devices in the vicinity of the conference system might cause the errors.

You can manually reset the ☹ icon behind "Error Indication" to the default icon (☺) (see page 111).

The error counter ("Break Counter") incrementally counts all errors and changes in the conference system (e.g. added conference units or connected and switched on ADN PS power supplies). Based on the changes of the counter's counts, you can conclude on the error source (e.g. if the counter rapidly increments when you wiggle the cable, this indicates a faulty cable).

You can manually reset the error counter ("Break Counter") (see page 110).

Performing a manual self-test –
“Start Self-Test”

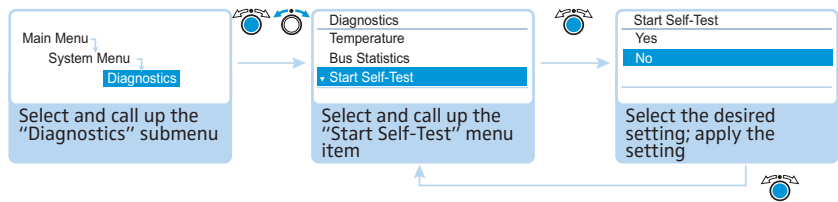

If the ADN CU1 central unit detects errors after switch-on or during operation:

- ▶ Eliminate these errors (see page 102 and following).
- ▶ Perform a manual self-test by selecting “Yes” in the “Start Self-Test” menu item. The conference is interrupted. The central unit now checks if a reported error still persists. If the error is eliminated, the corresponding error icon goes off after the self-test. If the error icon is still displayed, you have to take further steps to eliminate the error (see page 102 and following).

i Always perform the self-test after you have eliminated the reported errors. During the self-test, do not press any keys or buttons and do not change the set up of the conference system.

Resetting the error counter –
“Reset Break Indication”

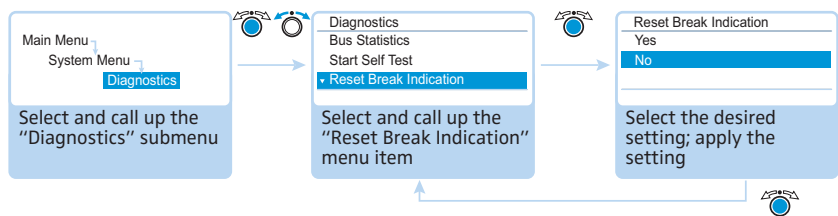

Possible settings: “Yes” and “No”

This menu item allows you to reset the error counter (“Break Count”) in the “Bus Statistic” menu item (see page 109).

Resetting the display of data bus errors – “Reset Error Indication”

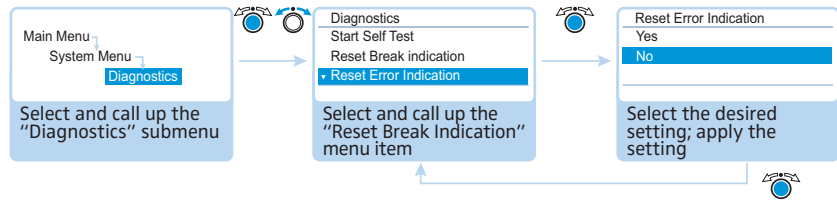

Possible settings: “Yes” and “No”

This menu item allows you to manually reset the display of data bus errors (“Error Indication”) in the “Bus Statistic” menu item to default (see page 109).

i We **strongly** recommend to always perform a self-test (see page 110) to make sure that the error is eliminated.

After a successful self-test, the error icons go off and the display of data bus errors is automatically reset to default.

Displaying the hardware and software version – “Versions” submenu

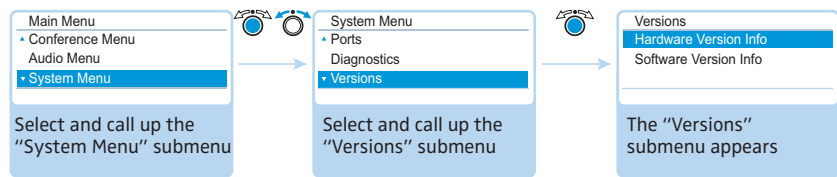

The “Versions” menu item provides information on your hardware and software versions.

Information on firmware updates for your conference system is available from your Sennheiser partner or from the download area on our website at www.sennheiser.com.

Displaying the hardware version – “Hardware Version Info”

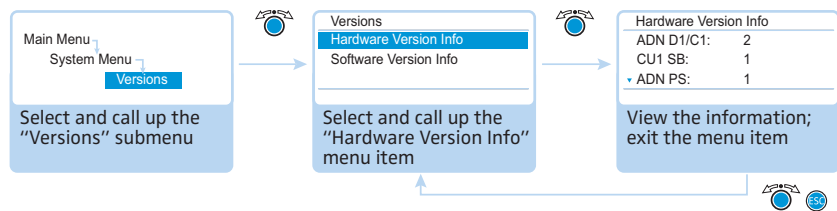

Possible entries	Hardware version
“ADN D1/C1”	ADN D1 or ADN C1 wired conference units
“ADN-W D1/C1”	ADN-W D1 or ADN-W C1 wireless conference units
“CU1 SB”	ADN CU1 central unit (Slave Board)
“ADN PS”	ADN PS power supplies
“ADN-W AM”	ADN-W AM antenna module

If the hardware versions used in the conference system are consistent, the version number (e.g. “2”) is displayed behind the entries. If the hardware versions are varying, “Varying” is displayed.

To ensure full operational reliability in a redundant ring topology, the hardware of the ADN C1 and ADN D1 has been revised. If you combine conference units with hardware revision 1 (no marking on the type plate) and conference units with hardware revision 2 (“HW: v2” is printed on the type plate), fail-safe operation is only possible to a limited extent.

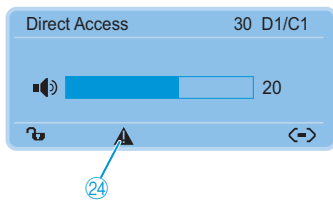

When conference units are connected in a redundant ring topology, the system warns you if inconsistent hardware or hardware revision 1 is used (the warning triangle 24 is displayed, see page 103).

To allow for operational reliability in a redundant ring topology:

- ▶ Check, if the hardware of the conference units is varying (display: "D1/C1: Varying").
- ▶ In a redundant ring topology, only use conference units with hardware revision 2.

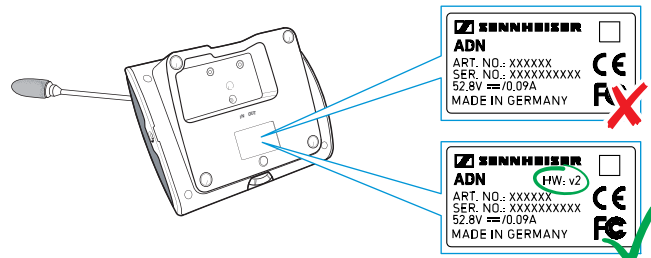

i If there is no redundant ring topology but the conference system nevertheless of inconsistent hardware versions, the IN socket 10 and the OUT socket 11 on one conference unit have been accidentally swapped.

To eliminate the warning message:

- ▶ Set up the conference system correctly (see page 58).

Displaying the software version – "Software Version Info"

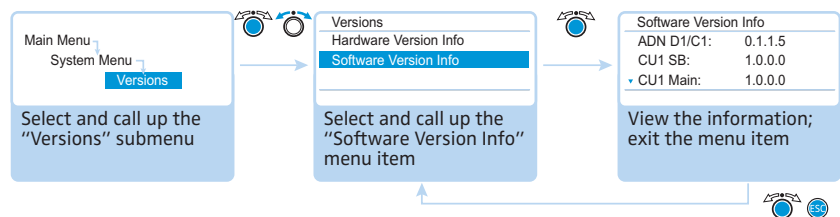

Possible entries	Hardware version
"ADN D1/C1"	ADN D1 or ADN C1 wired conference units
"ADN-W D1/C1"	ADN-W D1 or ADN-W C1 wireless conference units
"CU1 SB"	ADN CU1 central unit (Slave Board Software)
"CU1 Main"	ADN CU1 central unit (Main Software)
"ADN-W AM"	ADN-W AM antenna module

If the software versions used in the conference system are consistent, the version number is displayed (e.g. "0.1.1.5") behind the entries. If the software versions are varying, "Varying" is displayed.

Always use consistent and up-to-date software revisions in order to be able to use all functions. Further information on software updates for your ADN conference system is available from your Sennheiser partner.

Adjusting the language – “*Language”

Via the “*Language” menu item, you can adjust the language of the operating menu:

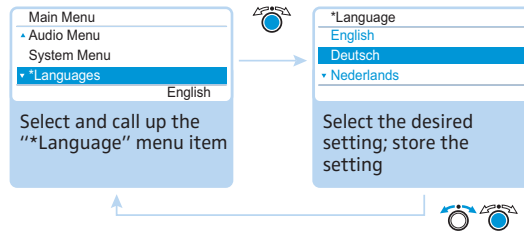

Possible settings: Chinese “中文”, Danish “Dansk”, German “Deutsch”, English “English”, Finnish “Suomi”, French “Français”, Dutch “Nederlands”, Italian “Italiano”, Japanese “日本語”, Norwegian “Norsk”, Russian “Русский”, Swedish “Svenska”, Spanish “Español”

This menu item is marked with an asterisk “*” so that it can be found even if a language unknown to you is adjusted.

Adjusting further settings – “Settings”

Adjusting network settings – “Network” submenu

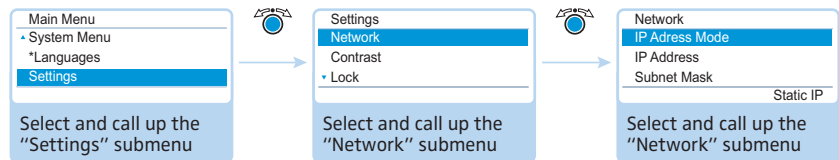

The “Network” submenu allows you to set the IP address allocation mode, the IP address, the subnet mask and the default gateway.

For detailed information on network settings, refer to the chapter “Preparing the Windows version of the software for use” on page 127.

Setting the IP address allocation mode – “IP Address Mode”

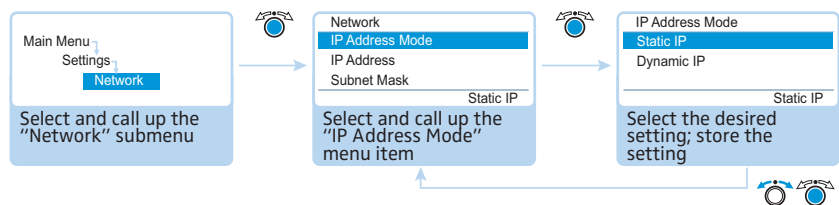

Possible settings: “Static IP” and “Dynamic IP”

i By selecting “Static IP”, you gain access to the submenus “IP Address”, “Subnet Mask” and “Gateway” (see the following sections).

Setting a static IP address – “IP Address”

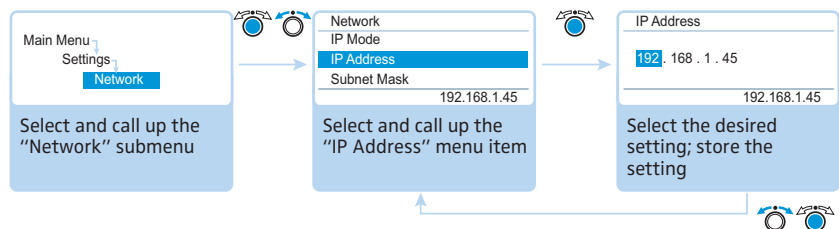

Setting a static subnet mask – “Subnet Mask”

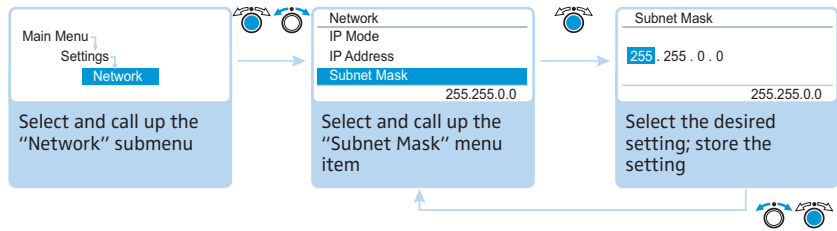

Setting the default gateway – “Gateway”

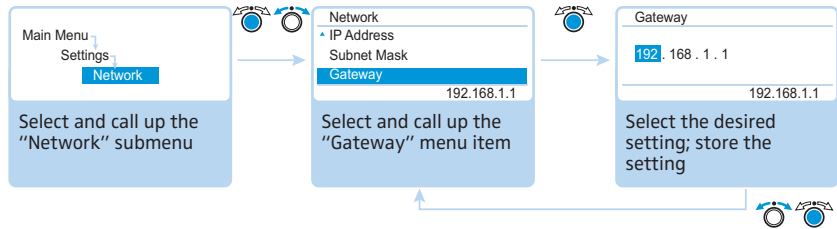

► Set the IP address of the default gateway.

Adjusting the contrast of the display panel – “Contrast”

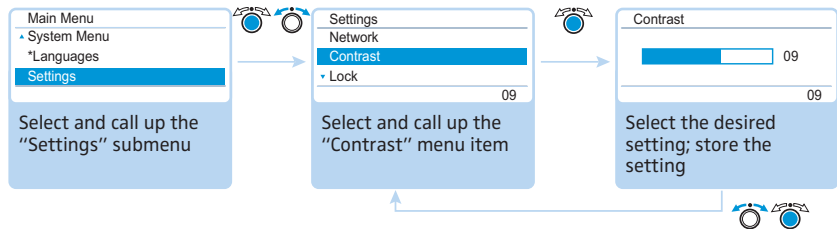

► You can adjust the contrast of the display panel in 15 steps.

Setting the lock mode – “Lock”

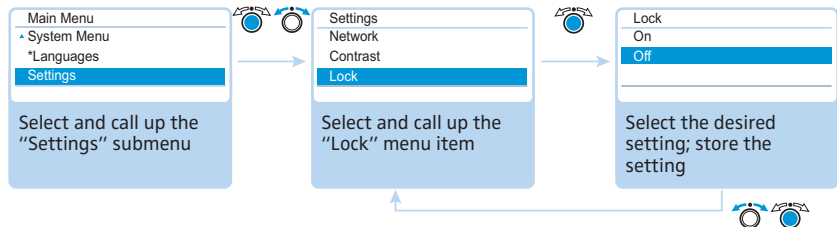

When you activate the lock mode, you are automatically returned to the standard display. For information on how to deactivate the lock mode, refer to the chapter “Deactivating the lock mode of the central unit” on page 83.

Restoring the factory default settings– “Restore Factory Defaults”

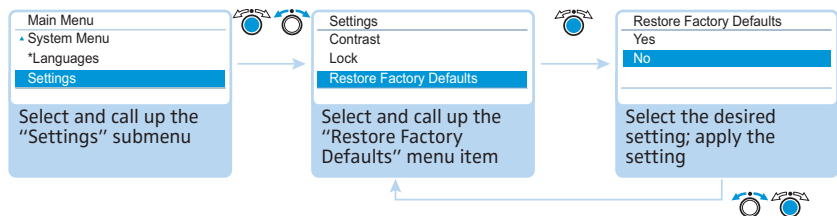

The “Restore Factory Defaults” menu item allows you to restore the factory default settings (see “Factory default settings” on page 253).

Running a conference

The character of your conference (i.e. the conditions under which the participants can take the floor or are granted speaking privileges) depends on the settings of the central unit (see page 90).

Possible settings: **“Direct Access”** [factory default], **“Override”**, **“Push to talk”** and **“Request”**

- **“Direct Access”** mode and **“Override”** mode:

These two conference modes do not require the use of a chairperson unit.

If the maximum number of speakers who can take the floor simultaneously (**“Microphone Limit”**) has not been reached, a further speaker can take the floor immediately.

Situation	The maximum number of speakers who can take the floor simultaneously (“Microphone Limit”) has been reached.
Event	A further speaker presses the microphone key on his or her conference unit.
Behavior	In “Direct Access” mode: The speaker has to wait until one of the current speakers passes on or loses his or her speaking privileges. He or she is then automatically granted speaking privileges. In “Override” mode: The speaker can take the floor immediately. The speaker with the longest speaking time loses his or her speaking privileges.

- **“Push to talk”** mode:

This conference mode does not require the use of a chairperson unit.

If the maximum number of speakers who can take the floor simultaneously (**“Microphone Limit”**) has not been reached, any speaker can take the floor immediately as soon as he or she presses and holds the microphone key. Releasing the microphone key will discontinue the speaking privileges.

Situation	The maximum number of speakers who can take the floor simultaneously (“Microphone Limit”) has been reached.
Event	A further speaker presses and holds the microphone key on his or her conference unit.
Behavior	Pressing and holding the microphone key causes no reaction. The speaker can only take the floor if the maximum number of speakers who can take the floor simultaneously drops below the specified limit value.



In **“Push to talk”** mode, you cannot deactivate a wireless conference unit using the microphone key.

- **“Request”** mode:

For this mode to function, a chairperson unit is required or the conference system must be controlled via the **“Conference Manager”** software.

In **“Request”** mode, the chairperson receives requests to speak and grants speaking privileges according to the FIFO principle (First In – First Out), i.e. the speaker with the longest waiting time is granted speaking privileges.

Situation	The maximum number of requests to speak has been reached (“Request Limit”).
Event	A further speaker makes a request to speak.
Behavior	The speaker can only make a request to speak if the maximum number of requests to speak drops below the specified limit value.



You can control the conference either via chairperson units (see the following chapters) or via the **“Conference Manager”** software (see page 125).

Operating a delegate unit

The operation of the ADN D1 wired conference unit and the ADN-W D1 wireless conference unit is identical.

Taking the floor/Making a request to speak

Depending on the conference mode set (see page 115), you can

- take the floor immediately or
- make a request to speak.

You then have to wait until the chairperson activates your microphone

If the conference mode is set so that you can take the floor immediately (“**Direct Access**” mode [factory default] or “**Override**” mode, see page 115):

- ▶ Press the microphone key ⑦.

Your microphone is activated and you can take the floor immediately. The microphone LED ⑧ and the signal light ring ② light up red. The loudspeaker ⑨ is muted. Depending on the conference mode and the microphone limit set, the microphone of the previous speaker will be deactivated.

If the conference mode is set so that you can take the floor immediately (“**Push to talk**” mode, see page 115):

- ▶ Press the microphone key ⑦ and keep it pressed for the duration of your contribution.

Your microphone is activated and you can take the floor immediately. The microphone LED ⑧ and the signal light ring ② light up red. The loudspeaker ⑨ is muted.

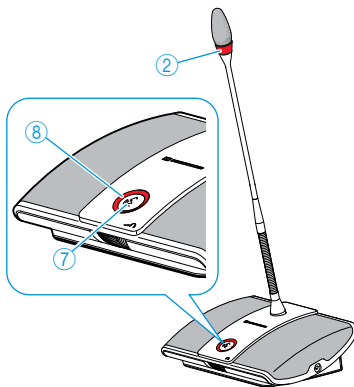

- i** In “**Push to talk**” mode, you cannot deactivate a wireless conference unit using the microphone key.

If the conference mode is set so that you first have to make a request to speak (“**Request**” mode, see page 115):

- ▶ Press the microphone key ⑦.

Your request to speak is added to the request-to-speak list.

Depending on the setting adjusted in the operating menu (see page 93):

- the microphone LED ⑧ flashes green and the signal light ring ② flashes red or
- only the microphone LED ⑧ flashes green.

When the chairperson grants you speaking privileges, your microphone is activated. The microphone LED ⑧ and the signal light ring ② light up red. The loudspeaker ⑨ is muted. Depending on the conference mode and the microphone limit set, the microphone of the previous speaker will be deactivated.

- i** With a chairperson unit, you can take the floor at any time, without first having to be granted speaking privileges.

If you are using delegate units **only**, you can only choose conference modes where speaking privileges do not have to be granted by a chairperson (“**Direct Access**”, “**Override**” or “**Push to talk**” mode, see page 115). Alternatively, you can use the “**Conference Manager**” software to control the delegate units (see page 203).

Deactivating the microphone/Canceling a request to speak

To deactivate the microphone when you have finished speaking or to cancel a request to speak (“Direct Access”, “Override” or “Request” mode):

- ▶ Press the microphone key ⑦ once more.
The microphone LED ⑧ and the signal light ring ② go off.

In “Push to talk” mode:

- ▶ Release the pressed microphone key ⑦.
The microphone LED ⑧ and the signal light ring ② go off.

Connecting headphones

You can connect mono or stereo headphones to the conference unit to listen to the floor channel. The headphone volume can be individually adjusted on the conference unit.

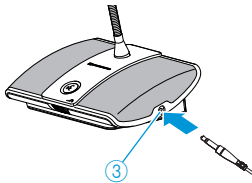

- ▶ Connect headphones with a 3.5 mm jack plug to the headphone socket ③.

Setting the headphone volume



CAUTION

Hearing damage due to high volumes!

Listening at high volume levels for long periods can lead to permanent hearing defects.

- ▶ Inform the conference participants about this fact.
- ▶ Set the volume to a medium level.
- ▶ Do not continuously expose yourself and other conference participants to high volumes.

- ▶ Put the headphones on.

To set the volume:

- ▶ Turn the headphone volume control ⑥
 - to the right to increase the volume or
 - to the left to reduce the volume.

At switch-off, the headphone volume is reset to a medium level.



The volume of the conference units’ loudspeakers can be set via the via the central unit’s operating menu (see page 120) or the “Conference Manager” software (see page 199).

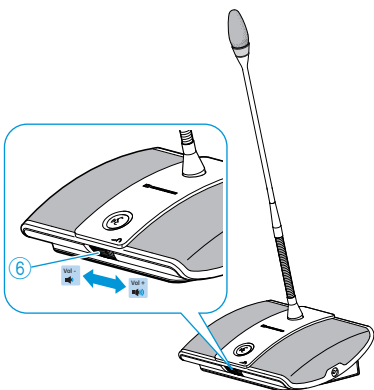

Operating a chairperson unit

The operation of the ADN C1 wired conference unit and the ADN-W C1 wireless conference unit is identical.

Beside the chairperson functions, chairperson units offer the same functions as delegate units (see page 116).

With a chairperson unit, you can take the floor at any time. If your conference system comprises several chairperson units, all chairperson units have equal rights.

Granting speaking privileges

If – in “Request” mode – a participant presses the microphone key on his or her delegate unit, he or she makes a request to speak. All participants who have made a request to speak will join a request-to-speak list.

Depending on the setting adjusted in the operating menu (see page 93):

- the microphone LED ⑧ flashes green and the signal light ring ② flashes red or
- only the microphone LED ⑧ flashes green

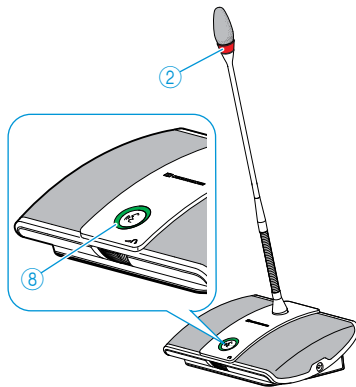

To grant speaking privileges to the next participant from the request-to-speak list:

- ▶ Press the Next key ⑤.

The next participant from the request-to-speak list is granted speaking privileges.

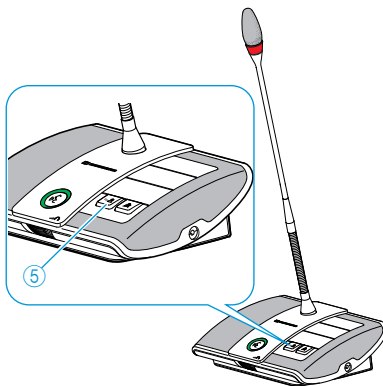

- i** If you are using the “Conference Manager” software, you can also grant speaking privileges with a mouse click (see page 211).

Ending a conference or withdrawing speaking privileges (cancel function)

Depending on the setting adjusted in the operating menu (see page 94):

- All LEDs go off and the delegate units are deactivated. A request-to-speak list, if available, is cleared.
- All currently active delegate units are deactivated. All requests to speak are retained.

- ▶ Briefly press the priority key ④.
The conference system behaves as set.

i If you are using the "Conference Manager" software, you can also deactivate all delegate units with a mouse click (see page 203).

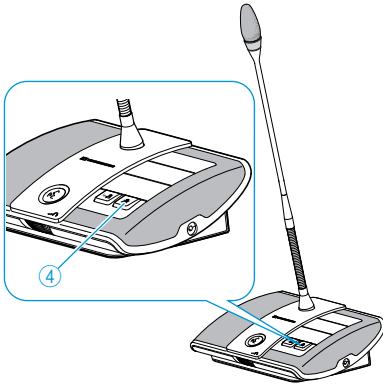

Muting all delegate units temporarily (priority function)

Using the priority function, the chairperson can interrupt a discussion at any time. The speaking privileges of all chairperson units remain active at any time.

- ▶ Keep the priority key ④ pressed for as long as you want to mute the conference units.

All conference units – except for the chairperson units – are muted immediately. The microphone LED ⑧ and the signal light ring ② of the previously active conference units flash red. You can take the floor immediately. The microphone LED ⑧ and the signal light ring ② your chairperson unit light up red.

- ▶ Release the priority key ④.
The muting of the conference units is canceled. The discussion is continued.

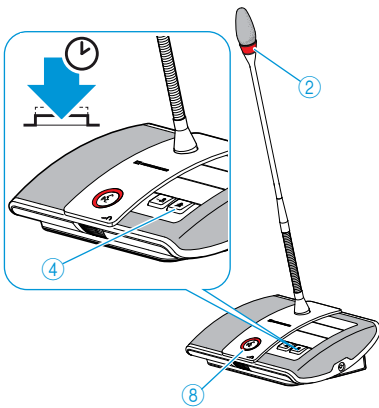

Setting the volume of the conference units' built-in loudspeakers

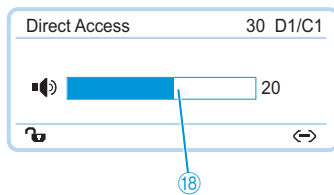

Increasing or reducing the volume of the conference units' built-in loudspeakers

You can set the volume of the conference units' built-in loudspeakers via the jog dial on the central unit. The standard display displays the current volume setting ¹⁸.



CAUTION

Danger of hearing damage due to loud hissing!

When the floor channel volume is set to a high level or when several participants speak simultaneously, feedback (loud hissing noise) can occur. This can cause hearing damage.

- ▶ Reduce the floor channel volume (see page 120, page 199 or page 214).
- ▶ Activate the "Feedback Suppression" function to be able to increase the volume before feedback can occur (see page 99 or page 202).
- ▶ Make sure that the "Audio Gain Reduction" function is activated (see page 98). This function reduces the gain per active microphone by the selected level and thus prevents feedback noise.
- ▶ Increase the distance between the individual conference units to at least 50 cm.



- ▶ Turn the jog dial
 - to the right to increase the volume or
 - to the left to reduce the volume.

Adjustment increments for the floor channel volume that can be adjusted via the central unit:

Value shown on the standard display	Adjustment increments for the floor channel volume
0	0
1 to 8	2.5 dB
9 to 16	2.0 dB
17 to 24	1.5 dB
25 to 32	1.0 dB



The volume of the conference units' loudspeakers can also be set via the central unit's operating menu (see page 98) or the "Conference Manager" software (see page 199).

Use the "Feedback Suppression" function to be able to increase the floor channel volume by up to 5 dB without feedback occurring (see page 99 or page 202).

Muting the conference units' loudspeakers for contributions coming from the conference units' microphones

The "Mic Loudspeaker Mute" function allows you to mute the conference units' loudspeakers so that contributions coming from the conference units' microphones are not reproduced (see page 100 or page 201).

Adding conference units to the conference system during operation

You can add conference units to the conference system during operation. The number of ADN C1 or ADN-W C1 chairperson units is limited to 10 max. (see page 28).

When adding conference units to the conference system, the “Processing ...” bar appear on the display panel of the ADN CU1 central unit. Added conference units appear on the display panel of the central unit ¹⁹ and are listed in the “Conference Manager” software (see page 213).

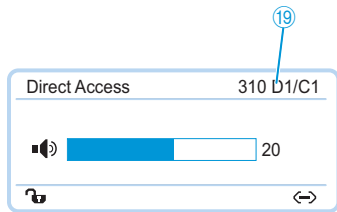

Adding wired conference units



- When adding conference units to the conference system, observe the maximum number of conference units in order to ensure operational reliability (see page 29).
- If you are operating more than 75 conference units or if your conference units are installed in rooms with obstacles, we recommend using several antenna modules (see page 32).

The delegate units are ready for immediate use. The chairperson units have to be re-initialized. Note that this will interrupt the conference (see page 94 or page 191).

Adding wireless conference units

Open access mode

If you are in open access mode (“Access Mode - Open”) (see page 96 or page 166), you can simply add additional wireless conference units to the conference system. Once the conference units are switched on (see page 78), they are automatically initialized. After approx. 10 seconds, the conference units are ready for operation. The wireless chairperson units have to be re-initialized. Note that this will interrupt the conference (see page 94 oder page 191).

Closed access mode

If you are in closed access mode (“Access Mode - Closed”), you can only add additional wireless conference units to a running conference using the “Conference Manager” software. In order to be able to use these additional wireless conference units, they have to be manually logged in to the antenna module (see “Manually logging in the wireless conference units (closed wireless conferencing) – “Access Mode - Closed”” on page 167).

Recording a conference

The ADN CU1 central unit allows you to record the floor channel and the channels of all active conference units as audio files on a USB mass storage device.

Recording possibilities and requirements

Recorded files

The audio files are recorded in WAVE PCM sound file format (mono, 32 kHz/16 bit). The floor channel is recorded throughout the entire conference so that the course of the conference can be retraced. In addition to the floor channel, the channels of all active conference units are recorded as individual audio files. The audio data is not encrypted.

For recording 1 hour of conferencing, you require approx. 230 MB of memory space per channel. If all channels of the conference system are being used (floor channel and 10 conference unit channels), you require approx. 2.5 GB of memory space.

The USB mass storage device must meet the following requirements:

USB mass storage device	Requirements
Recommended memory size	> 500 GB
File system*	NTFS FAT32
Partition	1
Connection	USB type A plug
Interface	USB 2.0
Power supply	via USB socket (approx. 500 mA) or separate mains unit

* When the maximum file size is reached (FAT32 = 4 GB), the recording is automatically split in several files. With NTFS files, the file size is limited by the memory size of the data storage device and the recordings don't have to be split in several files.

Storage location

The audio recordings are filed in the "ADN" folder on the USB mass storage device. For each recording of a conference, a new folder is created whose name consists of the name of the conference and the starting time (date and time). The name of the conference can be set via the "Conference Manager" software by saving the conference under an unambiguous name (see page 157).

Example: [ADN/CEO-Meeting_2011-05-02_160923](#)

File names

The file names of the audio recordings consist of the following:

- Floor channel:
"FloorChannel" and starting time (date and time)
Example: [.../FloorChannel_2011-05-02_160923.wav](#)
- Conference unit channel:
Type of conference unit, serial number of the conference unit, starting time of the contribution (date and time)
Example: [.../D1_SN104264_2011-05-02_162543.wav](#)

If a file name is already in use, the existing file will not be overwritten. The new file is automatically given a consecutively numbered suffix ("_01", "_02", etc.).



In order to get comprehensible and time-wise correct file names, the date and time of the ADN CU1 central unit have to be set correctly (see page 152).

Starting and monitoring audio recordings

You can start and monitor the audio recording via the central unit's operating menu or use the recording function of the "Conference Manager" software (see page 217).



CAUTION

Loss of an audio recording!

If you disconnect the USB mass storage device from the central unit during an audio recording, the audio recording can be rendered unusable due to faulty data.

- ▶ Stop the audio recording (see page 124) and make sure that the  icon is no longer displayed in the CU1 display panel before disconnecting the USB mass storage device from the central unit.

Starting the recording



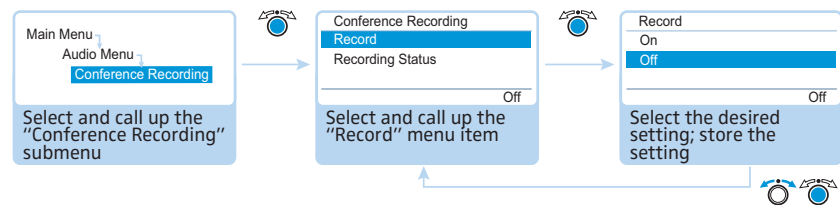

- ▶ Make sure that the USB mass storage device is correctly connected to the ADN CU1 central unit (see page 75).
- ▶ Call up the "Record" menu item and select "On". The recording is started. The  icon  displayed in the CU1 display panel.

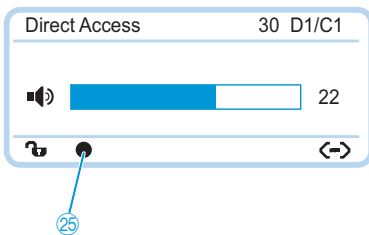

Monitoring an audio recording



The CU1 display panel displays the status of the audio recording:

Icon 	Meaning
	Audio recording in progress
	Memory space < 500 MB Depending on the number of channels recorded, the memory capacity will suffice for approx. 15 minutes of recording. Stop the recording (see page 124) and, if necessary, change the USB mass storage device.
	After finishing the audio recording, data is still written to the mass storage device.
	An error occurred during recording. The recording was interrupted. The central unit's display panel lights up red.

To view the recording status and the available memory space:

- ▶ Call up the "Recording status" submenu. The recording status and the available memory space are displayed.

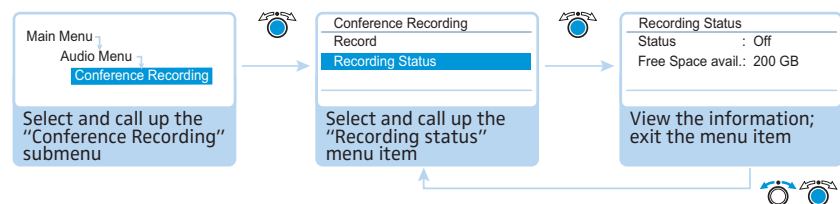

Stopping an audio recording

- ▶ Call up the "Record" menu item and select "Off".
The recording is stopped. The CU1 display panel does not display the recording icon.

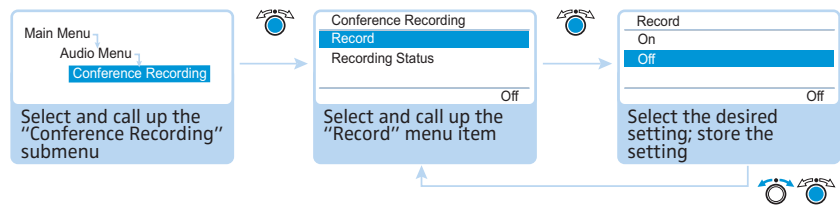

Using an audio recording

The recorded wav files can be played with a variety of media programs (e.g. Windows Media Player or Apple QuickTime Player).

- i** Make regular backups of the recorded audio files on independent media to guard against data loss.

Using the "Conference Manager" software

Possibilities of usage of the software and the conference system

The "Conference Manager" software allows for convenient configuration (including the configuration of all functions for wireless conferencing), management and control of the conference system. With the software, you can plan and graphically simulate conferences. Various configurations can be saved and thus be reused for other scenarios. In addition, you can use the software to control conferences. Conference rooms and conference participants are represented graphically, allowing you to keep track of and securely manage your conferences.

Hardware platforms for the software

The "Conference Manager" software can be run in two different ways:

Using the software preinstalled on the central unit



The software is preinstalled on the central unit. In order to be able to use the software, you have to connect a screen, mouse and keyboard directly to the central unit (see "Preparing the central unit's integrated software for use" on page 126).

Using the software on a Windows PC



Alternatively, you can install the software on a Windows PC. You then have to integrate the PC together with the central unit in a network (see "Preparing the Windows version of the software for use" on page 127).

Planning and simulating conferences – "Setup" operating mode

"Setup" and "Live" operating mode

In "Setup" operating mode, you can plan, configure and simulate conference situations. The software allows you to easily plan your conference by simulating a conference room, e.g. using lines, colors and photos. You can realistically simulate room situations, manage the names of the conference participants and assign these names to individual conference units. All conference settings (except manual channel selection and setting the signal strength for wireless conferencing) can be adjusted and saved via the "Conference Manager" software. These settings can then be used in "Live" operating mode.

Controlling conferences via the software – "Live" operating mode

In "Live" operating mode, you can control a conference from your screen. For controlling the conference, you can choose between two views: "Room View" and "Delegate View". You can see at a glance which delegates are currently speaking and which have made a request to speak and you can activate or deactivate individual conference units just with a mouse click. All settings for wireless conferencing (manual channel selection and setting the signal strength) can be configured directly in "Live" operating mode.

Establishing a connection between the software and the conference system

In order to be able to control a conference via the "Conference Manager" software, you have to connect the software to the conference system. If you are using a networked Windows PC, you can select different central units in the network. The software preinstalled on a central unit can only be connected to its central unit.

You can also use the "Conference Manager" software if there is no connection to the central unit in order to preconfigure a conference system (except for some functions for wireless conferencing).

The following overview shows the functions that are available depending on the connections status:

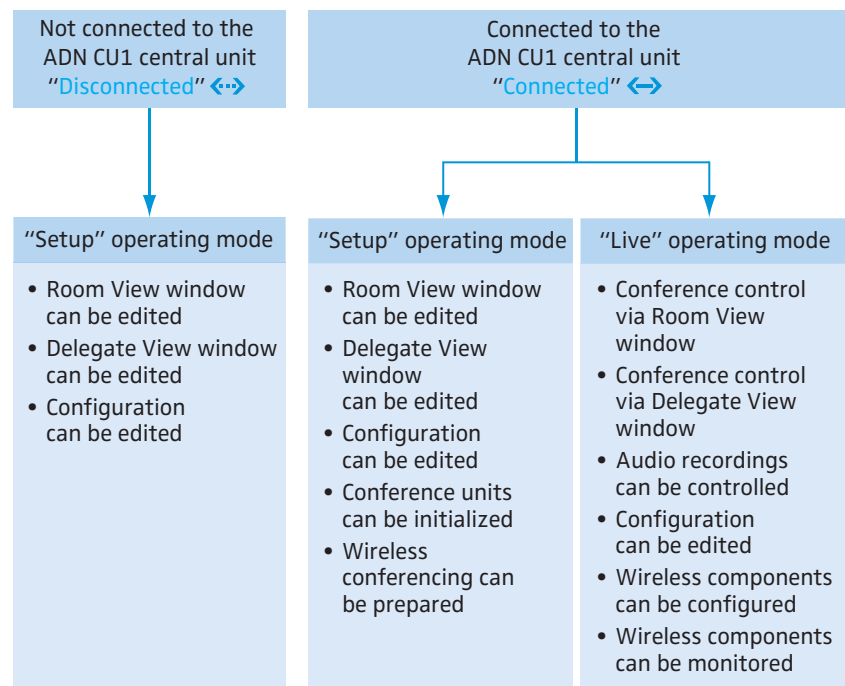

Preparing the central unit's integrated software for use

Connecting and configuring the screen, mouse, and keyboard



- ▶ Connect the screen, mouse, and keyboard to the central unit (see page 76).

To optimally use the screen, mouse, and keyboard, you have to configure the devices one time:

- ▶ Adjust the setting for the screen, mouse, and keyboard to your needs (see page 151).

Preparing the Windows version of the software for use

System requirements

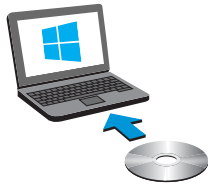

Component	Requirement
Processor	Intel Pentium 4 or AMD Athlon XP, 2 GHz or more
RAM	Min. 1 GB, depending on your operating system
Hard disk	Min. 500 MB free hard disk memory
Drives	DVD-ROM
Interfaces/network	Ethernet 100 MBit/s
TCP/IP internet protocol	Internet Protocol version 4 (IPv4)
Screen	Minimum resolution: 800 x 600 pixels Recommended: 1024 x 768 pixels
Operating system	Microsoft Windows XP Professional with SP 3 Microsoft Windows Vista mit SP2 Microsoft Windows 7 Microsoft Windows 8

Installing the "Conference Manager" software

i The following steps describe the installation of the "Conference Manager" software on a PC running Windows 8. The installation on a PC running Windows XP, Windows Vista or Windows 7 is performed in a similar way.

To install the software, you require administrator rights.

- ▶ Close all running applications.
- ▶ Start the "ADNSetup.exe" file in the "Software/ADN System Software" folder on the enclosed DVD-ROM.

A confirmation prompt appears:

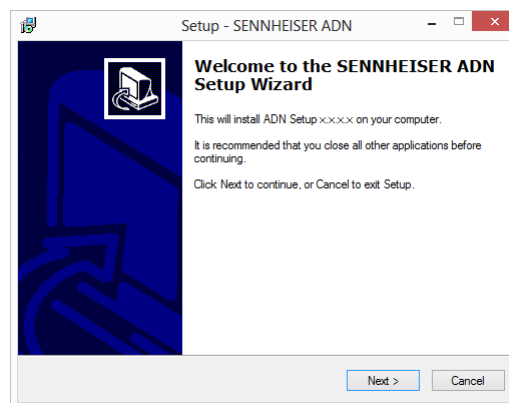

- ▶ Click the "Next" button. After you have accepted the license agreement, a confirmation prompt appears:

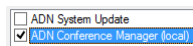
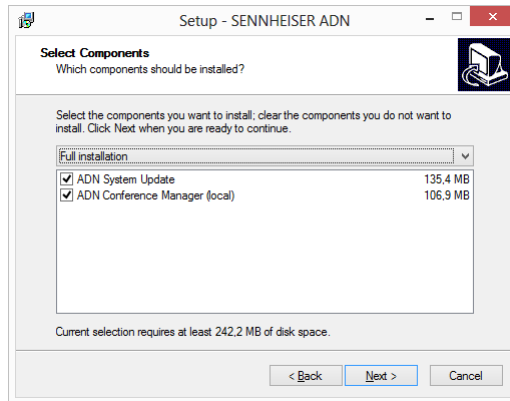

- ▶ Untick the "ADN System Update" check box.
- ▶ Make sure that the "ADN Conference Manager (local)" check box is ticked.
- ▶ Click the "Next" button. A summary of the selected installation settings is displayed:

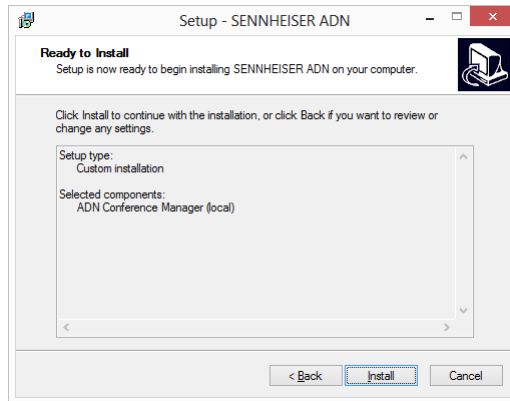

- ▶ Confirm this summary by clicking the "Install" button. A confirmation prompt appears:



- ▶ Click the "Next" button.
A selection window for specifying the installation location appears:

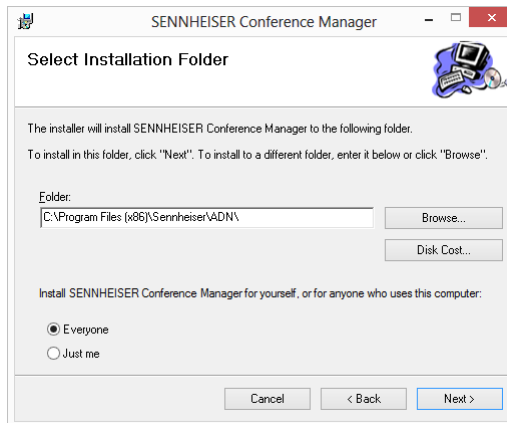

- ▶ Use the default or select an installation path.
- ▶ Click the "Next" button.
A summary of the selected installation settings is displayed:

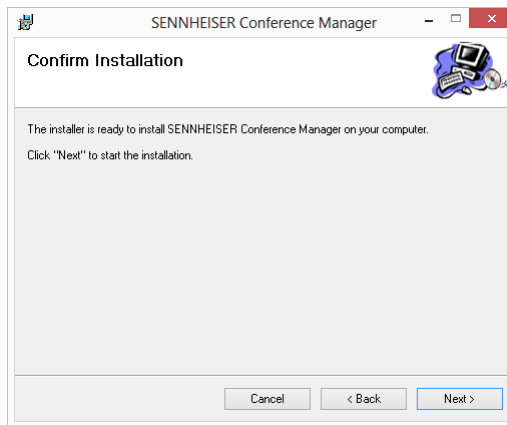

- ▶ Confirm this summary by clicking the "Next" button.
The installation is performed and a confirmation appears:

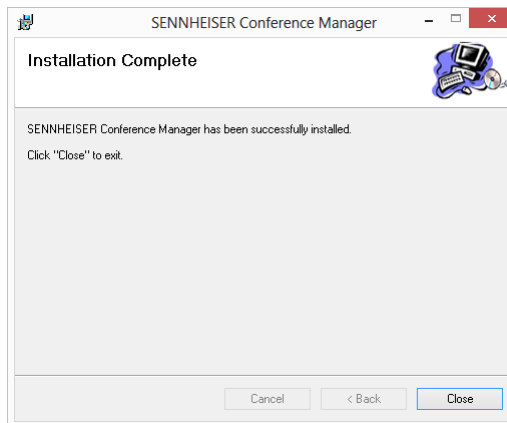

- ▶ Click the "Close" button.
A confirmation appears.
- ▶ Click the "Finish" button.
The software has been successfully installed.

 Information on the firmware update of the ADN products ("ADN System Update") can be found in the "ADN System Software Setup" manual included on the DVD-ROM (supplied with the central unit) or at www.sennheiser.com.

Uninstalling the "Conference Manager" software

You can uninstall the "Conference Manager" software using the installation wizard on the DVD-ROM or using the Windows Control Panel (category "Add or Remove Programs", entry "Sennheiser Conference Manager").

If you use the installation wizard to uninstall the software, the wizard automatically starts in repair mode:

- ▶ Start the "ADNSetup.exe" file in the "Software/ADN System Software" folder on the DVD-ROM supplied with the central unit.
- ▶ Select "Remove Sennheiser Conference Manager".



- ▶ Click the "Finish" button.
The software is uninstalled.

Adjusting the network settings

To enable communication between the central unit and the Windows PC:

- ▶ Make sure that the network communication between the central unit and the Windows PC is not blocked by a proxy server and/or a firewall. Ports 53248, 53249, 53250, 53251, 53252 are used for communication and port 21 is used for FTP transfer.
- ▶ Ask your system administrator if a **static** IP address with a default gateway is to be used or if the IP address is to be assigned **dynamically**.

If you have to use a static IP address with a default gateway, ask for the static IP address, the subnet mask and the IP address of the default gateway.

- ▶ Use the information provided by your system administrator to adjust the network settings of your central unit. Proceed as described under **B** (Windows XP, see page 133; Windows Vista, see page 135; Windows 7, see page 138; Windows 8, see page 142).

If you have to make the decision whether to use **static** or **dynamic** IP addressing, proceed as follows:

- i** If the central unit is directly connected to a Windows PC, we recommend dynamic IP address assignment. Depending on your operating system, configure the network settings of the PC and adjust the central unit as described under **A** (Windows XP, see page 132; Windows Vista, see page 135; Windows 7, see page 137; Windows 8, see page 141).

The devices automatically detect whether IP address assignment is via DHCP or Zero Configuration Networking (Zeroconf). This process can take several minutes.

Configuring the network settings on a PC running Windows XP

- ▶ Click "Start" and then select "Control Panel".

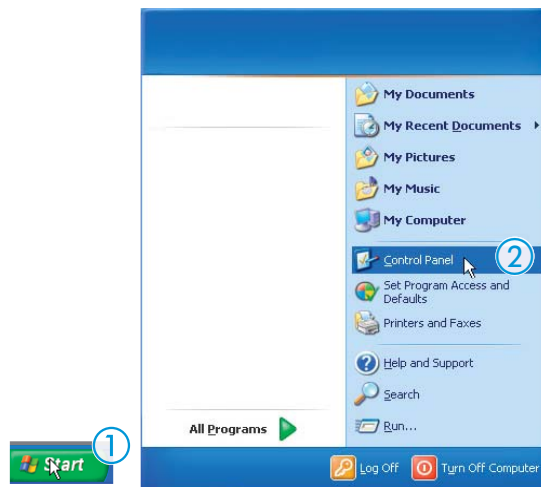

The "Control Panel" window appears.

- ▶ Double click "Network and Internet Connections".



The "Network and Internet connections" window appears.

- ▶ Click "Network Connections" in the right column.



The "Network Connections" window appears.

- ▶ Double-click "Local Area Connection".



The "Local Area Connection Status" window appears.

- ▶ Click the "Properties" button.

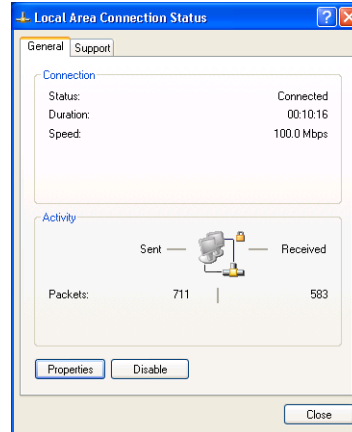

The "Local Area Connection Properties" window appears.

- ▶ In the "This connection uses the following items" box, scroll to the bottom.
- ▶ Double-click "Internet Protocol (TCP/IP)".

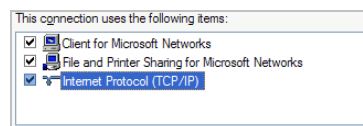

The "Internet Protocol (TCP/IP) Properties" window appears.

Here you can see whether the Windows PC is assigned a dynamic IP address **A** or a static IP address **B** in the network. Adjust your central unit as follows:

A Dynamic IP address

The Windows PC is assigned a **dynamic** IP address in the network.

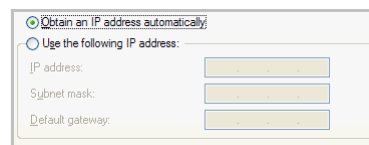

Settings to be adjusted via the central unit (see page 113):

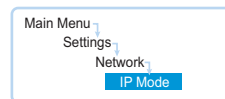

- ▶ On the central unit, call up the "IP Mode" menu item.
- ▶ Select "Dynamic IP".
The central unit is automatically integrated in the network and no further steps have to be taken.

B Static IP address

The Windows PC is assigned a **static** IP address with a default gateway in the network.

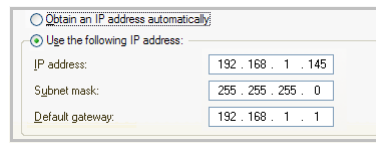

Settings to be adjusted via the central unit (see page 113):

- ▶ On the central unit, call up the "IP Mode" menu item.

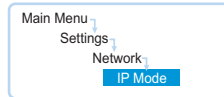

- ▶ Select "Static IP".
- ▶ Determine the network part of the IP address of the Windows PC, the subnet mask and the default gateway and note them down:

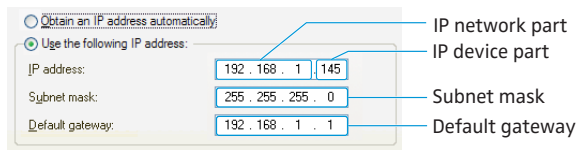

In this example, the network part is "192.168.1".

- ▶ On the central unit, call up the "IP-Address" menu item.

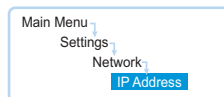

- ▶ Set the network part of the IP address to the value retrieved from your Windows PC.
- ▶ Set the device part (the last three digits) of the IP address to a value ("1" - "254") that is neither used by your PC nor by another computer in your network (in this example, the device part must not be "145").
- ▶ On the central unit, call up the "Subnet mask" menu item.

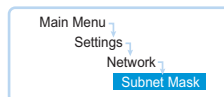

- ▶ Set the subnet mask (in this example "255.255.255.0").
- ▶ On the central unit, call up the "Gateway" menu item.

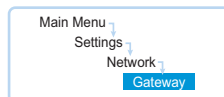

- ▶ Set the IP address of the default gateway (in this example "192.168.1.1"). The network connection is established via a static IP address.

Configuring the network settings on a PC running Windows Vista

- ▶ Click "Start" and then select "Control Panel".

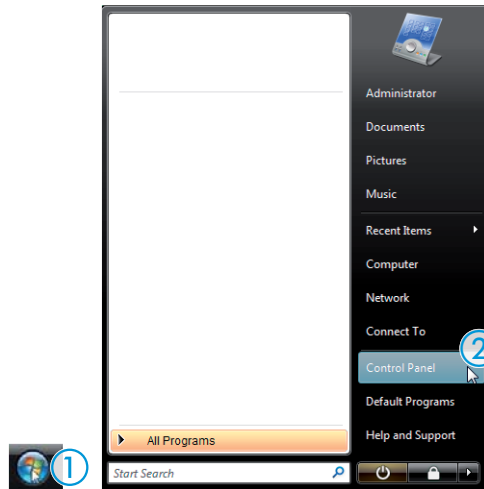

The "Control Panel" window appears.

- ▶ Click "View network status and tasks".

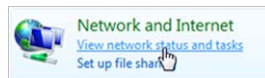

The "Network and Sharing Center" window appears.

- ▶ Click "Manage network connections" in the left column.

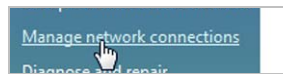

The "Network Connections" window appears.

- ▶ Double-click "Local Area Connection".

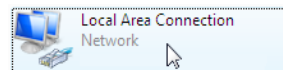

The "Local Area Connection Status" window appears.

- ▶ Click the "Properties" button.

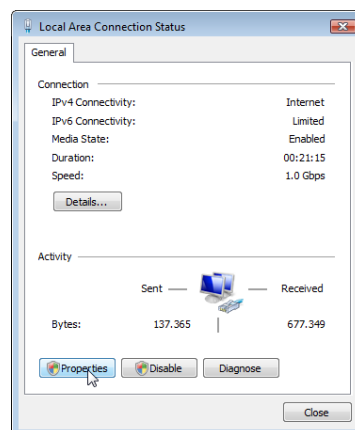

The "Local Area Connection Properties" window appears.

- ▶ In the "This connection uses the following items" box, double-click "Internet Protocol Version 4 (TCP/IPv4)".

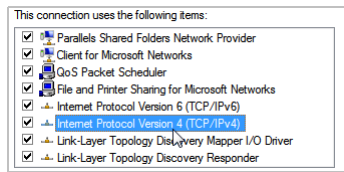

The "Internet Protocol (TCP/IP) Properties" window appears.

Here you can see whether the Windows PC is assigned a dynamic IP address **A** or a static IP address **B** in the network. Adjust your central unit as follows:

A Dynamic IP address

The Windows PC is assigned a **dynamic** IP address in the network.

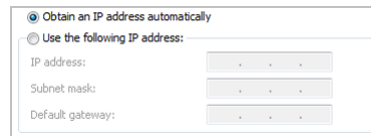

Settings to be adjusted via the central unit (see page 113):

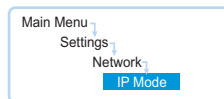

- ▶ On the central unit, call up the "IP Mode" menu item.
- ▶ Select "Dynamic IP".
The central unit is automatically integrated in the network and no further steps have to be taken.

B Static IP address

The Windows PC is assigned a **static** IP address with a default gateway in the network.

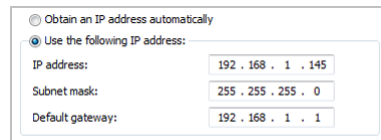

Settings to be adjusted via the central unit (see page 113):

- ▶ On the central unit, call up the "IP Mode" menu item.

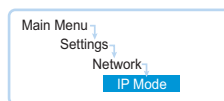

- ▶ Select "Static IP".
- ▶ Determine the network part of the IP address of the Windows PC, the subnet mask and the default gateway and note them down:

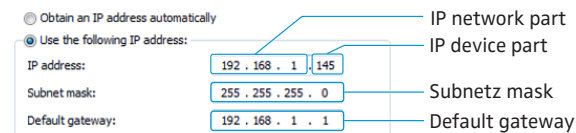

In this example, the network part is "192.168.1".

- ▶ On the central unit, call up the "IP-Address" menu item.

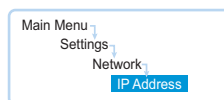

- ▶ Set the network part of the IP address to the value retrieved from your Windows PC.
- ▶ Set the device part (the last three digits) of the IP address to a value (“1” - “254”) that is neither used by your PC nor by another computer in your network (in this example, the device part must not be “145”).
- ▶ On the central unit, call up the “Subnet mask” menu item.

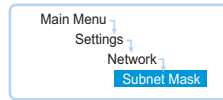

- ▶ Set the subnet mask (in this example “255.255.255.0”).
- ▶ On the central unit, call up the “Gateway” menu item.

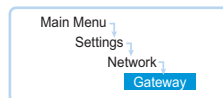

- ▶ Set the IP address of the default gateway (in this example “192.168.1.1”). The network connection is established via a static IP address.

Configuring the network settings on a PC running Windows 7

- ▶ Click “Start” and then select “Control Panel”.

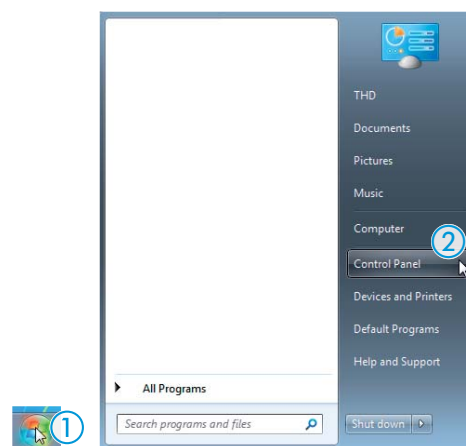

The “Control Panel” window appears.

- ▶ Click “View network status and tasks”.

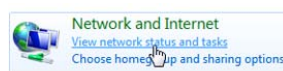

The “Network and Sharing Center” window appears.

- ▶ Click “Change adapter settings” in the left column.

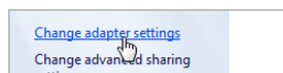

The “Network Connections” window appears.

- ▶ Double-click “Local Area Connection”.

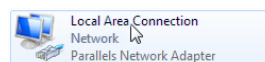

The “Local Area Connection Status” window appears.

- ▶ Click the "Properties" button.

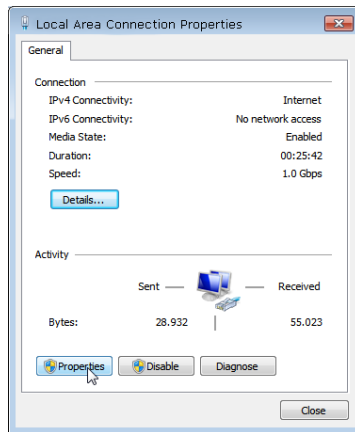

The "Local Area Connection Properties" window appears.

- ▶ In the "This connection uses the following items" box, double-click "Internet Protocol Version 4 (TCP/IPv4)".

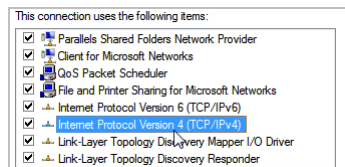

The "Internet Protocol (TCP/IP) Properties" window appears.

Here you can see whether the Windows PC is assigned a dynamic IP address **A** or a static IP address **B** in the network. Adjust your central unit as follows:

A Dynamic IP address

The Windows PC is assigned a **dynamic** IP address in the network.

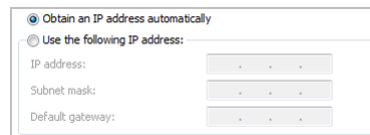

Settings to be adjusted via the central unit (see page 113):

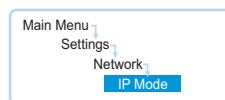

- ▶ On the central unit, call up the "IP Mode" menu item.
- ▶ Select "Dynamic IP".
The central unit is automatically integrated in the network and no further steps have to be taken.

B Static IP address

The Windows PC is assigned a **static** IP address with a default gateway in the network.

Obtain an IP address automatically:

Use the following IP address:

IP address: 192 . 168 . 1 . 145

Subnet mask: 255 . 255 . 255 . 0

Default gateway: 192 . 168 . 1 . 1

Settings to be adjusted via the central unit (see page 113):

- ▶ On the central unit, call up the "IP Mode" menu item.

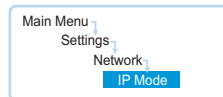

- ▶ Select "Static IP".

- ▶ Determine the network part of the IP address of the Windows PC, the subnet mask and the default gateway and note them down:

Obtain an IP address automatically:

Use the following IP address:

IP address: 192 . 168 . 1 . 145

Subnet mask: 255 . 255 . 255 . 0

Default gateway: 192 . 168 . 1 . 1

Annotations:

- IP network part: 192 . 168 . 1
- IP device part: 145
- Subnet mask: 255 . 255 . 255 . 0
- Default gateway: 192 . 168 . 1 . 1

In this example, the network part is "192.168.1".

- ▶ On the central unit, call up the "IP-Address" menu item.

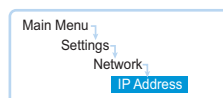

- ▶ Set the network part of the IP address to the value retrieved from your Windows PC.
- ▶ Set the device part (the last three digits) of the IP address to a value ("1" - "254") that is neither used by your PC nor by another computer in your network (in this example, the device part must not be "145").
- ▶ On the central unit, call up the "Subnet mask" menu item.

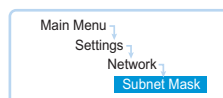

- ▶ Set the subnet mask (in this example "255.255.255.0").
- ▶ On the central unit, call up the "Gateway" menu item.

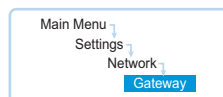

- ▶ Set the IP address of the default gateway (in this example "192.168.1.1"). The network connection is established via a static IP address.

Configuring the network settings on a PC running Windows 8

- ▶ Right-click the Metro Start screen.
The "All Apps" button appears at the bottom of the screen.



- ▶ Click the "All Apps" button.
An overview of all apps appears.

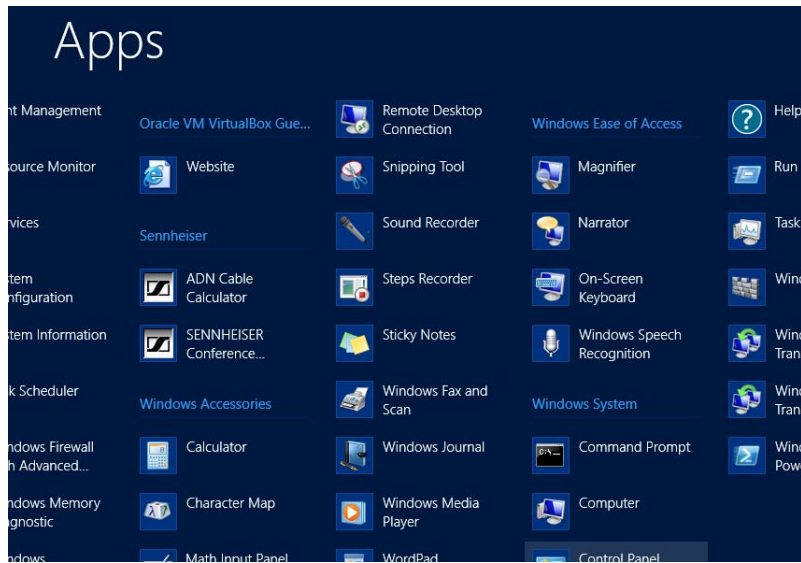

- ▶ Under "Windows System", click "Control Panel".
The "Control Panel" window appears.

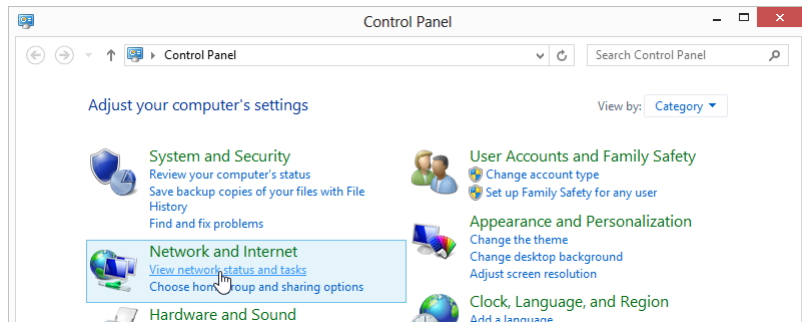

- ▶ Under "Network and Internet", click "View network status and tasks".
The "Network and Sharing Center" window appears.

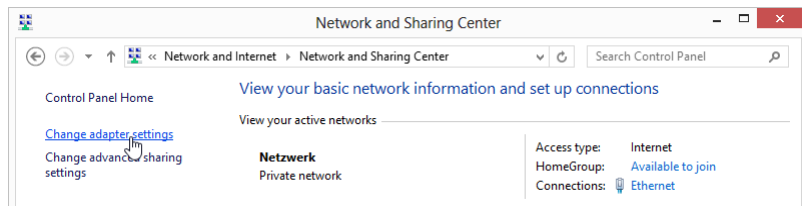

- ▶ Click "Change adapter settings".
The "Network Connections" window appears.

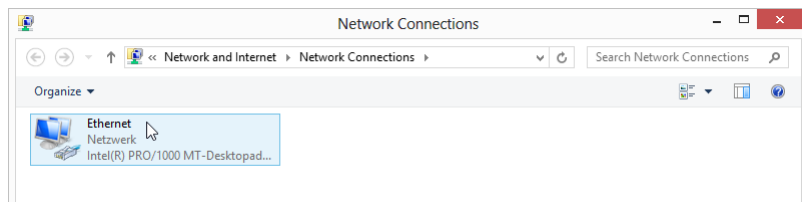

- ▶ Double-click "Ethernet".
The "Ethernet Status" window appears.

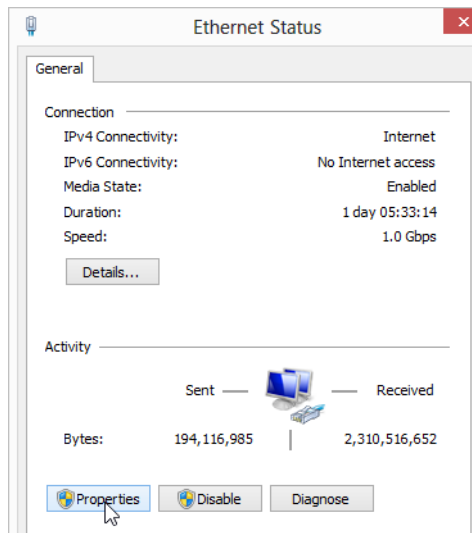

- ▶ Click the "Properties" button.
The "Ethernet Properties" window appears.

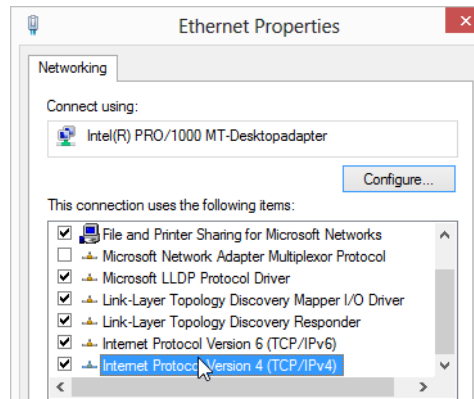

- ▶ In the "This connection uses the following items" box, double-click "Internet Protocol Version 4 (TCP/IPv4)".
The "Internet Protocol Version 4 (TCP/IPv4) Properties" window appears.

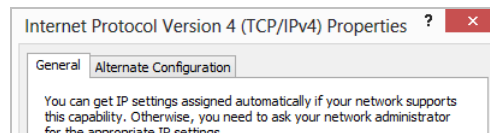

Here you can see whether the Windows PC is assigned a dynamic IP address **A** or a static IP address **B** in the network. Adjust your central unit as follows:

A Dynamic IP address

The Windows PC is assigned a **dynamic** IP address in the network .

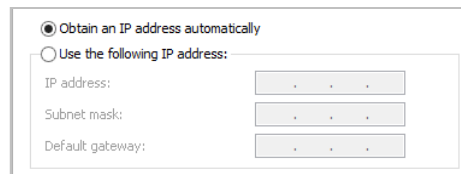

Settings to be adjusted via the central unit (see page 113):

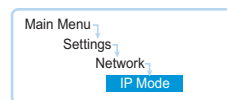

- ▶ On the central unit, call up the "IP Mode" menu item.
- ▶ Select "Dynamic IP".
The central unit is automatically integrated in the network and no further steps have to be taken.

B Static IP address

The Windows PC is assigned a static IP address with a default gateway in the network.

Obtain an IP address automatically
 Use the following IP address:
 IP address: 192 . 168 . 1 . 145
 Subnet mask: 255 . 255 . 255 . 0
 Default gateway: 192 . 168 . 1 . 1

Settings to be adjusted via the central unit (see page 113):

- ▶ On the central unit, call up the "IP Mode" menu item.

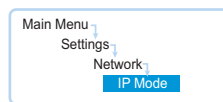

- ▶ Select "Static IP".

- ▶ Determine the network part of the IP address of the Windows PC, the subnet mask and the default gateway and note them down:

Obtain an IP address automatically
 Use the following IP address:
 IP address: 192 . 168 . 1 . 145
 Subnet mask: 255 . 255 . 255 . 0
 Default gateway: 192 . 168 . 1 . 1

In this example, the network part is "192.168.1".

- ▶ On the central unit, call up the "IP-Address" menu item.

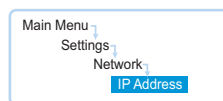

- ▶ Set the network part of the IP address to the value retrieved from your Windows PC.
- ▶ Set the device part (the last three digits) of the IP address to a value ("1" - "254") that is neither used by your PC nor by another computer in your network (in this example, the device part must not be "145").

- ▶ On the central unit, call up the "Subnet mask" menu item.

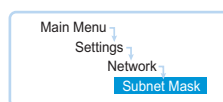

- ▶ Set the subnet mask (in this example "255.255.255.0").
- ▶ On the central unit, call up the "Gateway" menu item.

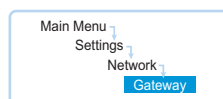

- ▶ Set the IP address of the default gateway (in this example "192.168.1.1"). The network connection is established via a static IP address.

Starting/exiting the software

Central unit's integrated software



To start the central unit's integrated software:

- ▶ Switch on the central unit and the connected screen. The "Conference Manager" software is started in "Setup" operating mode and the Room View window is displayed. The "Open" window appears in the foreground.

i When using the "Conference Manager" software for the first time, select the desired language (see page 152). All screenshots in this manual show the English-language version of the software.

i If the screen connected to the central unit does not show anything, it may be that the screen resolution is set too high. In this case, reset the screen resolution:

- ▶ Press the key combination "CTRL" + "SHIFT" + "F1". The screen resolution is reset to 800 x 600 pixels.

To exit the software:

- ▶ If necessary, save your current configuration (see page 157).
- ▶ Switch off the central unit.

Windows version of the software

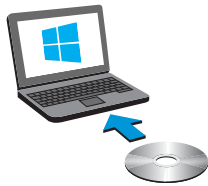

To start the software:

- ▶ Double-click the program icon on the desktop.

Or:

- ▶ Click "Start" > "All Programs" > "Sennheiser" > "ADN" > "SENNHEISER Conference Manager".

The "Conference Manager" software is started in "Setup" operating mode and the Room View window is displayed. The "Open" window appears in the foreground.

i When using the "Conference Manager" software for the first time, select the desired language (see page 152) and set the correct date and time (see page 151). All screenshots in this manual show the English-language version of the software.

To exit the software:

- ▶ If necessary, save your current configuration (see page 157).
- ▶ Click the  icon on the toolbar.



Getting to know and adjusting the basic features of the software

Overview of the software

The main application window of the "Conference Manager" software consists of permanently visible elements and of views that depend on the operating mode.

The following screenshot shows the Windows version of the "Conference Manager" software:

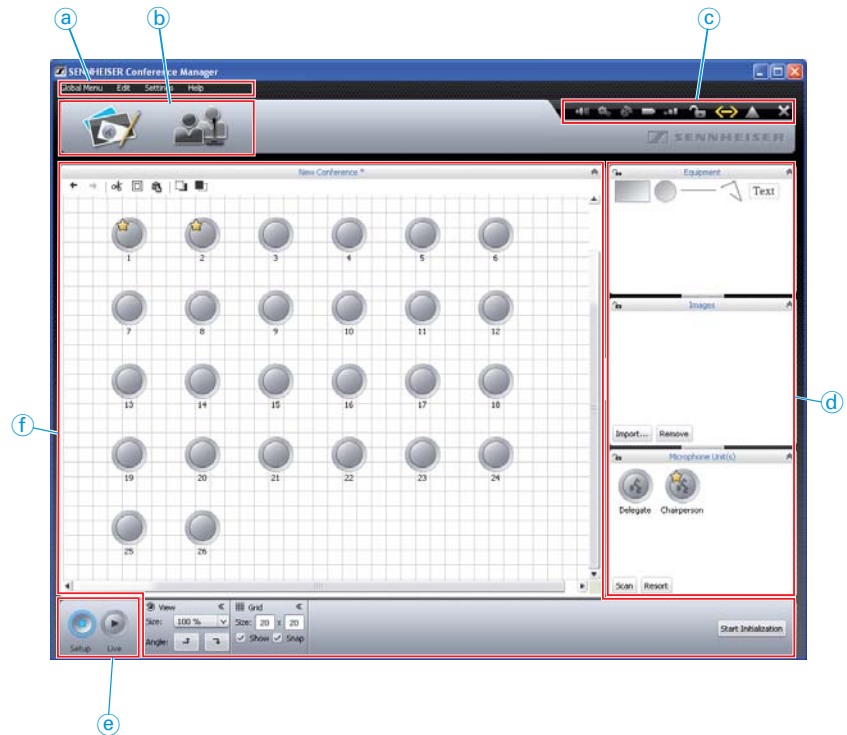

- a Menu bar
- b Buttons for selecting the views
- c Toolbar
- d Library panels
- e Buttons for selecting the operating mode
- f Views

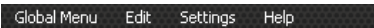
Menu bar 

Menu	Submenu	Function	page
Global Menu	New Conference	Creates a new configuration	155
	Open Conference...	Loads an existing configuration	156
	Delete Conference...	Deletes an existing configuration	159
	Close	Closes the current configuration	159
	Save	Saves the current configuration (locally or on the central unit)	157
	Save as...	Saves the current configuration under a different file name (locally or on the central unit)	
	Connect.../Disconnect...	Establishes a connection to the central unit/disconnects a connection	154
	AutoLoad ...	Automatically loads the central unit's configuration at startup	157
	Exit*	Exits the software	143
Edit	Undo	Reverses the last action you performed	181
	Redo	Reverses the last Undo action	
	Cut	Cuts an object and pastes it to the clipboard	181
	Copy	Copies an object to the clipboard	
	Paste	Pastes an object from the clipboard	
	Delete	Deletes an object	
	Step to back	Moves the object one level to the back	182
	Step to front	Moves the object one level to the front	
	Select All	Selects all objects	176
	Full Screen*	Activates/deactivates full screen mode	151
	Select Delegates List Columns	Shows and hides columns in the participant list (Delegate View window)	150
Settings	Conference Settings ...	Opens the conference settings	195
	Audio Settings ...	Opens the audio settings	199
	Wireless Settings ...	Opens the settings for wireless conferencing	95
	Conference Recording	Opens the audio recording function	217
	Language	Adjusts the language	152
	Set Password ...	Sets the password protection	152
	Network...	Opens the network settings	153
	Re-init Conference	Re-initializes the conference units	191
	Restore Factory Settings	Restores the factory default settings of the software	154
	System Properties**	Opens the hardware settings for screen, mouse and keyboard	151
	Switch Off all wireless Units	Switches off all wireless conference units	154
Help	Help ...	Starts the help function	–
	About ...	Displays the current software version	–

* only visible when you are using the Windows version of the software

** only visible when you are using the central unit's integrated software



Alternatively, you can also use the keyboard shortcuts listed next to the commands.

Buttons for selecting the views [ⓑ]



Button	Function
	Changes to the Room View window where you can configure and/or control the conference system via a graphical interface. The Room View window changes depending on whether "Setup" or "Live" operating mode is set (see page 147).
	Changes to the Delegate View window where you can create a participant list and control the conference by means of the list. The Delegate View window changes depending on whether "Setup" or "Live" operating mode is set (see page 147).

Toolbar [ⓒ]





Button	Function
	Opens the "Audio Settings" window (see page 199)
	Opens the "Conference Settings" window (see page 195)
	Opens the "Wireless Settings" window (see page 95)
	Displays the battery status of the conference units and shows/hides the battery status next to the conference unit icons – "Battery Status" (see page 208): All conference units have a sufficient battery charge (battery charge >10%) At least one conference unit has a low battery charge (battery charge <10%)
	Displays the status of the RF link of the conference units and shows/hides the RF status next to the conference unit icons – "RF Status" (see page 208): All conference units have a good RF link At least one conference unit has a bad RF link (RF signal quality <20%)
	Displays the status of the central unit's lock mode (see page 199): "device unlocked" "device locked"
	Displays the connection status between the central unit and the "Conference Manager" software and/or a media control system (see page 154): "device disconnected" "device connected"
	Displays messages and errors and opens the "Event Log" function (see page 219): Event log, no error messages are reported Error messages are reported
	Closes the software ("Exit") (see page 143)

* only available in the Windows version of the software

Buttons for selecting the operating mode ©



Operating mode activated	Function
	Sets the "Setup" operating mode which allows you to configure the conference system (see page 148). The button is highlighted in blue. The Room View window and the Delegate View window change their appearance in accordance with the selected operating mode.
	Sets the "Live" operating mode which allows you to control a conference using the software (see page 149). The button is highlighted in red. The Room View window and the Delegate View window change their appearance in accordance with the selected operating mode.

Selecting operating modes and views

In "Setup" and "Live" operating mode, you can switch between the Room View window and the Delegate View window.

Views of the software depending on the operating mode

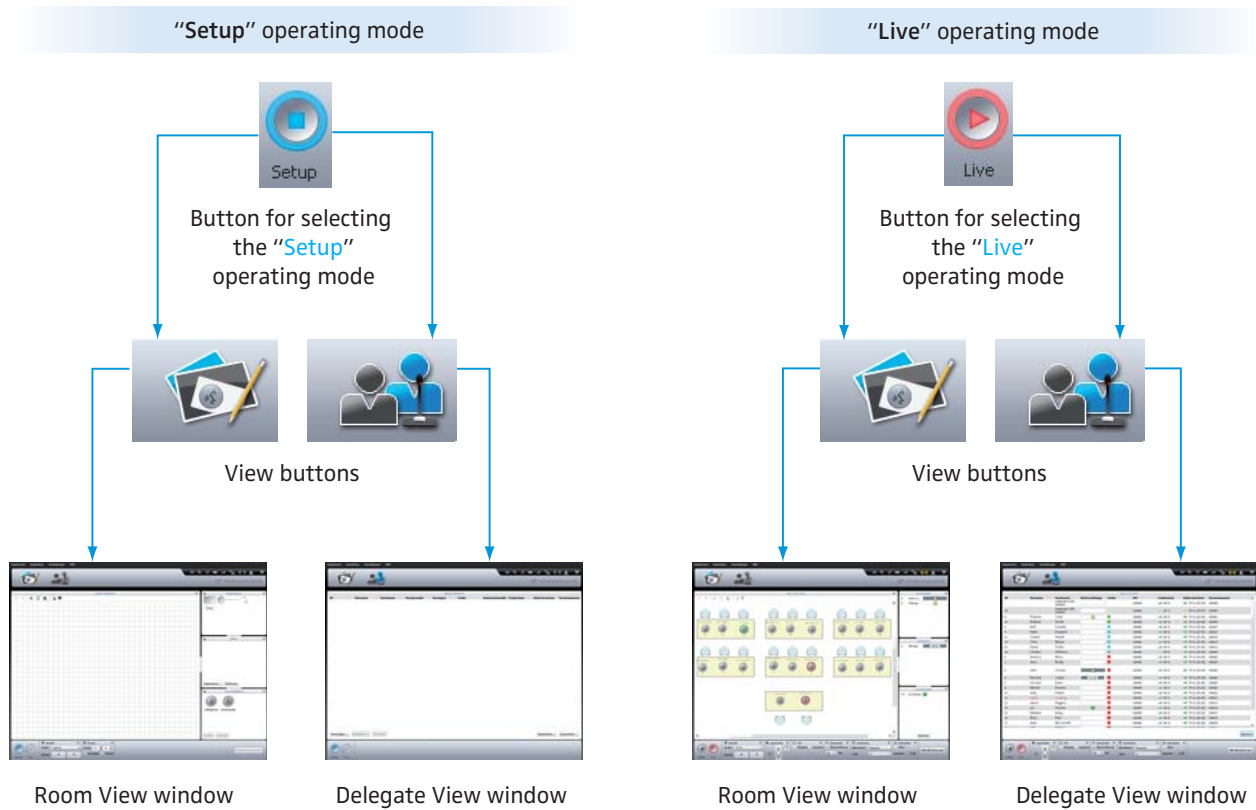

Selecting the "Setup" operating mode



- ▶ Click the "Setup" button. The software changes to "Setup" operating mode and the "Setup" button is highlighted in blue.

To display the Room View:

- ▶ Click the Room View button

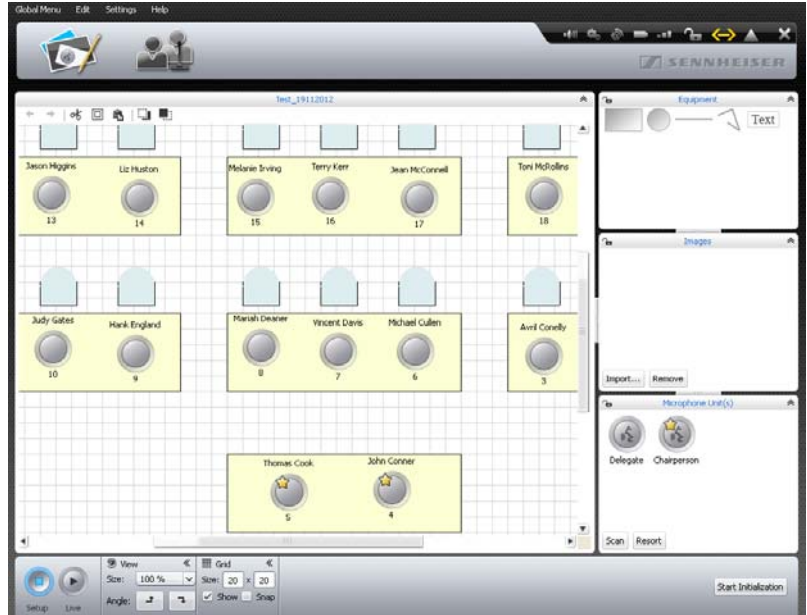

To display the Delegate View window:

- ▶ Click the Delegate View button

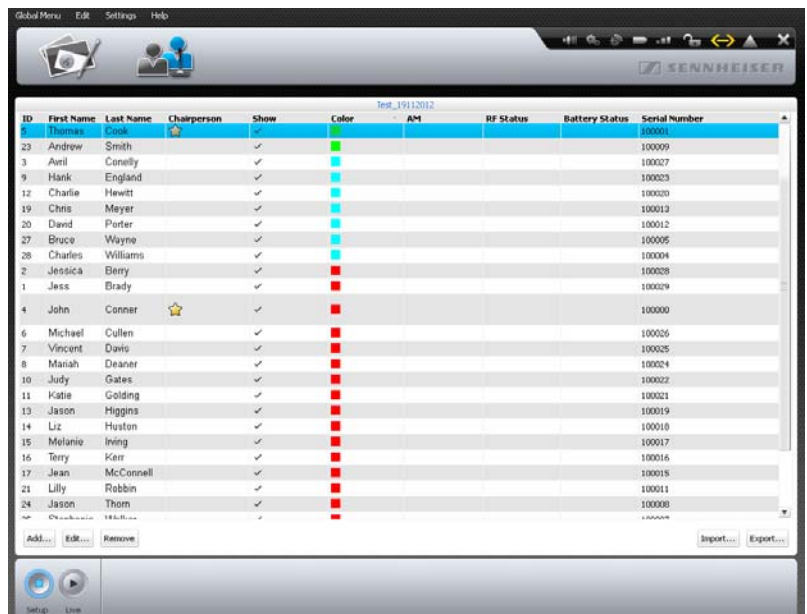

Selecting the "Live" operating mode



▶ Prepare the "Live" operating mode and activate it (see page 203).

To display the Room View window:

▶ Click the Room View button

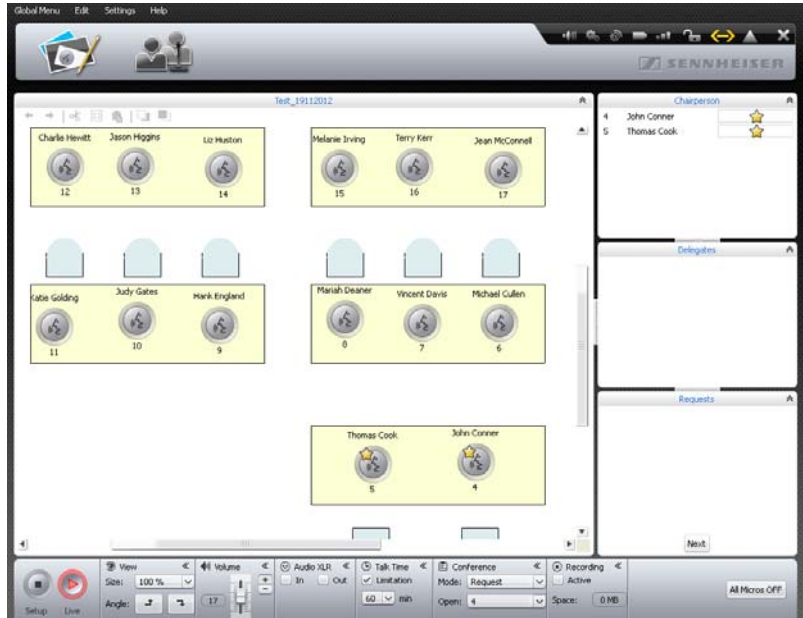

To display the Delegate View window:



▶ Click the Delegate View button



Adjusting the View windows to your needs

You can adjust the Room View window and the Delegate View window to your needs. The library panels can be hidden or shown and can be changed in size. Changes to the View windows are not automatically saved and are reset to the factory default settings when the software is exited.

Hiding, showing and resizing the library panels

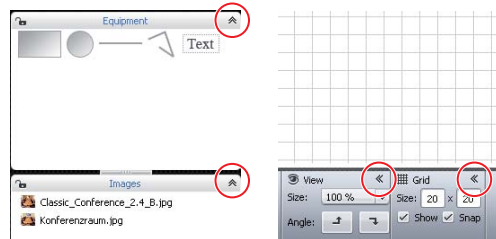

Library panels that show the  or  icon can be hidden and shown:



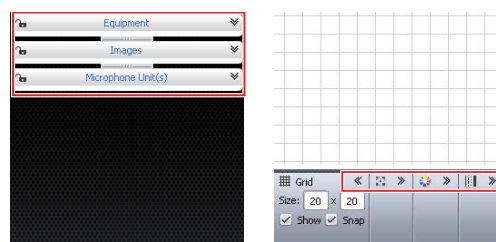

The header of a library panel is always displayed.







To hide a library panel:





- ▶ Click the  or  icon in the header of the library panel that you want to hide.

To show a library panel:

- ▶ Click the  or  icon in the header of the library panel that you want to show.



To change the size of a library panel:

- ▶ Move over the  or  icon between the library panels. The mouse pointer  becomes the resize tool .
- ▶ Adjust the size of the library panel as needed.

 The  and  icons show whether the “Equipment”, “Images” or “Microphone Unit(s)” library panel is locked () or unlocked () (see page 184).

Adjusting the column width of the participant list

To change the column width of the participant list:

- ▶ Move the mouse pointer over the header of the participant list. The mouse pointer  becomes the resize tool .
- ▶ Adjust the column width as needed.



 A double-click automatically adjusts the column width to fit the contents.

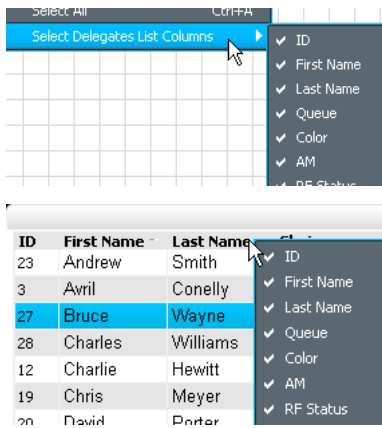

To show and hide columns in the participant list when "Live" operating mode is activated (in "Setup" operating mode, all columns are always shown):

- ▶ In the menu bar, click "Edit" > "Select Delegates List Columns".

Or:

- ▶ Right-click the header of the participant list. A list of the columns that can be shown in "Live" operating mode appears.
- ▶ Activate the desired columns by clicking on the corresponding entries in the list:

Setting	Visibility of the columns in "Live" operating mode
activated	The column in the participant list is shown
<input checked="" type="checkbox"/> ID	
deactivated	The column in the participant list is hidden
<input type="checkbox"/> ID	

Using the full screen mode of the Windows software

- ▶ In the menu bar, click "Edit" > "Full Screen". The full screen mode of the software is activated/deactivated.

Adjusting the screen, mouse, and keyboard settings and the date/time setting of the central unit*

- ▶ In the menu bar, click "Settings" > "System Properties". The "System Properties" window appears.

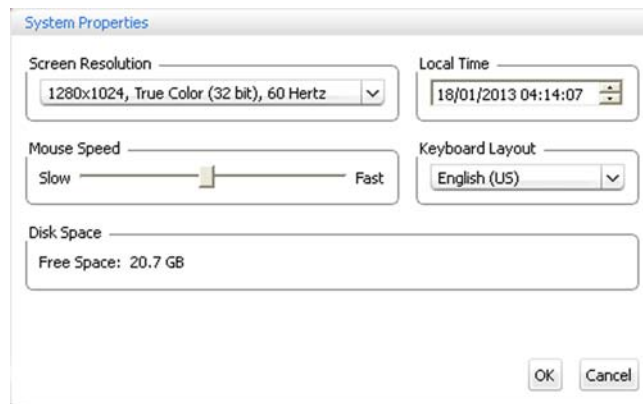

To adjust the screen settings:

- ▶ Select the desired value from the drop-down list in the "Screen Resolution" box. The screen resolution should be at least 800 x 600 pixels (recommended: 1024 x 762 or 1280 x 1024 pixels).



i Screen resolutions and refresh rates are automatically adapted to the connected screen so that you can always select the optimum settings for e.g. flat screen monitors or video projectors. It might be necessary to restart the central unit in order to be able to select the optimum settings for your screen.

* only if you are using the central unit's integrated software

If the screen connected to the central unit does not show anything, it may be that the screen resolution is set too high. In this case, reset the screen resolution:

- ▶ Press the key combination "CTRL" + "SHIFT" + "F1".
The screen resolution is reset to 800 x 600 pixels.

To adjust the mouse pointer speed:



- ▶ In the "Mouse Speed" box, move the slider to
 - "Slow" to reduce the pointer speed or to
 - "Fast" to increase the pointer speed.

To adjust to keyboard layout to the central unit (e.g. cyrillic keyboard layout):

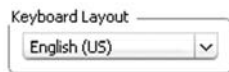

- ▶ Select the desired keyboard layout from the drop-down list in the "Keyboard Layout" box.

To adjust the date and time of the central unit:

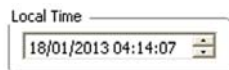

- ▶ Highlight the individual digits in the "Local Time" box.
- ▶ Enter the date and time via the keyboard or click the buttons to increase or reduce the highlighted digits.
- ▶ Click "OK".
The settings are saved and the "System Properties" windows closes.

To get information on the free memory available on the central unit:

The "Disk Space" box in the "System Properties" window provides information on the free memory available on the central unit.



Adjusting the language

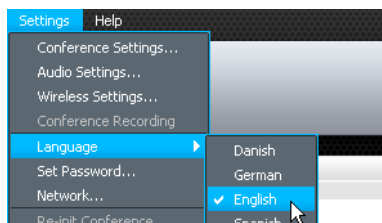

- ▶ In the menu bar, click "Settings" > "Language".
A list with the available languages appears: Chinese "中文", Danish "Dansk", German "Deutsch", English "English", Finnish "Suomi", French "Français", Dutch "Nederlands", Italian "Italiano", Japanese "日本語", Norwegian "Norsk", Russian "Русский", Swedish "Svenska" and Spanish "Español".
- ▶ Click the desired language.
The language of the software is changed.

Using a password

You can use a password to protect existing configurations against unauthorized change. This means that all settings adjusted in "Setup" operating mode are locked. However, password-protected configurations can be used in "Live" operating mode and settings can be adjusted.

Protecting configurations with a password and changing a password

- ▶ In the menu bar, click "Settings" > "Set Password...". The "Set Password" window appears.

To create a new password:

- ▶ Leave the "Old Password" field empty.

To change an existing password:

- ▶ Enter the existing password into the "Old Password" field.
- ▶ Enter the new password into the "New Password" and "Confirm new Password" fields.

The password can consist of up to 16 characters.

- i** If you do not want to use a password, leave the "New Password" and "Confirm new Password" fields empty.

- ▶ Click "OK".

The new password is saved and the configuration is password-protected. Before any changes to the configuration are accepted, you are prompted to enter the password set.

- i** The master key combination allows you to unlock password-protected configurations:

- ▶ Press the key combination "CTRL" + "SHIFT" + "F10". An existing password is deleted.

Adjusting network settings

- i** If you make changes to the settings in the "Network Settings" window, an existing network connection can be lost!

- ▶ In the menu bar, click "Settings" > "Network...". The "Network Settings" window appears.

To automatically integrate the central unit into a network using a **dynamic** IP address:

- ▶ Select the "Obtain an IP Address automatically" option button.
- ▶ Click "OK".

The setting is applied and the "IP Address" and "Subnet mask" fields display the automatically assigned addresses.

To manually integrate the central unit in a network using a **static** IP address, subnet mask and default gateway:

- ▶ Select the "Use the following IP Address" option button.
- ▶ Enter the desired IP address into the "IP address" field.

- ▶ Enter the desired subnet mask address into the “Subnet mask” field.
- ▶ Enter the desired IP address of the default gateway into the “Default gateway” field.

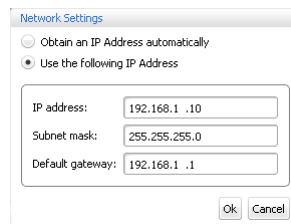

- ▶ Click “OK”.
The setting is applied.

i For further information on the network configuration of the conference system, refer to page 131.

Loading the factory default settings

- ▶ In the menu bar, click “Settings” > “Restore Factory Settings”.
All software settings and, if wireless conference units are connected, all settings of the connected wireless conference units are reset to default.

i If the screen connected to the central unit does not show anything, it may be that the screen resolution is set too high. In this case, reset the screen resolution:

- ▶ Press the key combination “CTRL” + “SHIFT” + “F1”.
The screen resolution is reset to 800 x 600 pixels.

Switching off all connected wireless conference units

- ▶ In the menu bar, click “Settings” > “Switch Off all wireless Units”.
A confirmation prompt appears.
- ▶ Click “OK”.
All wireless conference units connected to the conference system are switched off.

Using the conference system and the software

Connecting the software to the central unit

To connect the “Conference Manager” software to the central unit:

- ▶ Start the software (see page 143).
The “Open” window appears.

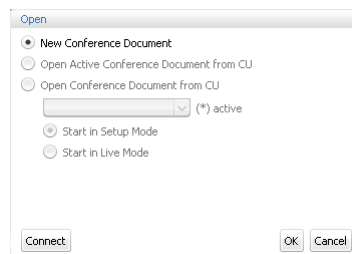

- ▶ Click the “Connect” button.
Or:

- ▶ In the menu bar, click "Global Menu" > "Connect...".
The "Connect to CU" window appears, showing a list of available central units.

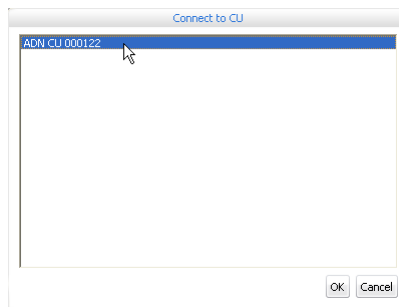

- ▶ Select the desired central unit.

i If the desired central unit is not listed, check the network settings (see page 131) and observe the notes in the following chapter.

i The "Connect" button is also available in other program windows. Its function is always to connect the "Conference Manager" software to the central unit.

i The Windows version of the software allows you to select different central units in the network. The central unit's integrated software can only be connected to its own central unit.

- ▶ Click "OK".
The software is connected to the selected central unit. The "Device Connected" icon  appears on the toolbar.

Disconnecting the connection to the central unit

- ▶ In the menu bar, click "Global Menu" > "Disconnect...".
A confirmation prompt appears.
- ▶ Click "OK".
The connection to the central unit is disconnected. If necessary, the software changes to "Setup" operating mode.

Creating a new configuration

- ▶ In the menu bar, click "Global Menu" > "New Conference Document".
The "Open" window appears.

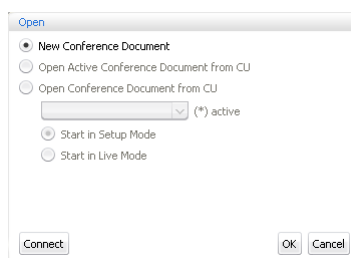

- ▶ Select the "New Conference Document" option button.
- ▶ Click "OK".
A new configuration is created. The software changes to "Setup" operating mode and the Room View window is displayed (see page 148).

Loading a configuration

- ▶ In the menu bar, click “Global Menu” > “Open Conference...”.
The “Open” window appears.

If the software is connected to a central unit (see page 154), you can load three types of configurations:

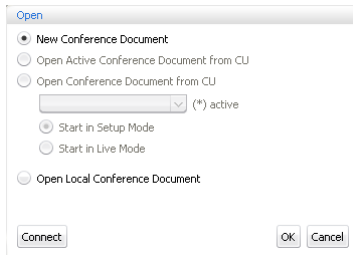

Loading a configuration ...	Actions
... of an active (running) conference	<p>To load your configuration in “Live”[*] operating mode:</p> <ul style="list-style-type: none"> ▶ Select the “Open Active Conference Document from CU” option button. ▶ Click “OK”. <p>To select the operating mode (“Setup”^{**} or “Live”) in which the configuration is to be loaded:</p> <ul style="list-style-type: none"> ▶ Select the “Open Conference Document from CU” option button. ▶ Select the configuration of an active conference (marked with an asterisk “*”) from the drop-down list. ▶ Select the operating mode (“Setup” or “Live”) and click “OK”.
... of a non-active conference	<p>To select the operating mode (“Setup” or “Live”) in which the configuration is to be loaded:</p> <ul style="list-style-type: none"> ▶ Select the “Open Conference Document from CU” option button. ▶ Select the configuration of a non-active conference (not marked with an asterisk “*”) from the drop-down list) ▶ Select the operating mode (“Setup” or “Live”) and click “OK”.
... of a conference saved locally on the hard disk ^{***}	<ul style="list-style-type: none"> ▶ Select the “Open Local Conference Document” option button. ▶ Click “OK” and select the desired configuration from the “Open Conference” file selection dialog box (file extension “*.adn”). ▶ Click “OK”. The conference is loaded in “Setup” operating mode.

* After loading a configuration, the conference automatically starts in “Live” operating mode. Also observe the information on page 158.

** In “Setup” operating mode, you can adapt existing configurations to your needs.

*** Only available if you are using the Windows version of the software – even if there is no connection to a central unit.

 If you open a configuration in “Setup” operating mode, the password set will be prompted (where applies) (see page 152).

Activating/deactivating automatic loading of a configuration

To automatically load a saved configuration at startup of the conference system:

- ▶ In the menu bar, click "Global Menu" > "AutoLoad...". The "Autoload Properties" window appears.
- ▶ Establish a connection to the central unit (see page 154).
- ▶ Select the "Enable Autoload" option button.
- ▶ Select the desired configuration from the drop-down list.
- ▶ Click "OK".

At the next startup of the conference system, the selected configuration is automatically loaded in "Live" operating mode.

To deactivate automatic loading of a configuration:

- ▶ Select the "Disable Autoload" option button.
- ▶ Click "OK".

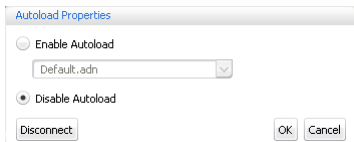
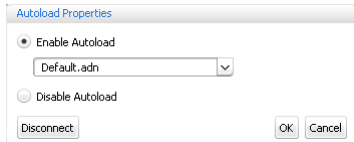

Eliminating connection problems when a configuration is autoloaded

If no connection to the central unit can be established or if the configuration cannot be found, an error message appears.

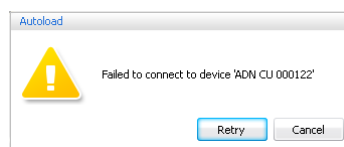

- ▶ Check if the central unit is correctly connected* (see page 127) and switched on (see page 77).
- ▶ Make sure that the network communication between the software and the central unit is not blocked by a proxy server and/or a firewall.
- ▶ If necessary, disconnect an existing connection to the central unit in order to establish a new connection (see next section).
- ▶ Click "Retry".



Saving a configuration

You can save any number of configurations on either the central unit or locally on the connected Windows PC.

To save a newly created configuration on the central unit:

- ▶ In the menu bar, click "Global Menu" > "Save". The "Save Conference" window appears.

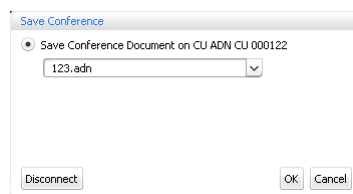

- ▶ If necessary, establish a connection to the central unit (see page 154).
- ▶ Select the "Save Conference Document on CU #####" option button.
- ▶ Enter a file name into the drop-down list box.

* only if you are using the Windows version of the software

- ▶ Click "OK".
The file is saved on the central unit.

You can click "Global Menu" > "Save" to save a configuration that already has a file name; there is no further query.

i Settings made in "Live" operating mode or via the central unit's operating menu are immediately saved to the current configuration.

To protect your configuration, we recommend that you save it under a different file name **before** changing to "Live" operating mode:

- ▶ Make sure that the software is connected to the central unit (see page 154).
- ▶ Load the active configuration in "Setup" operating mode (marked with an asterisk "*", see page 156).
This configuration contains the last settings used.
- ▶ Save the configuration under a different file name (see above).

i For wireless conferencing, the settings "Channel Selection - Manual" and "Output Power" are saved directly in the connected ADN-W AM antenna module. These settings are not saved in a configuration file of the "Conference Manager" software. If you replace the antenna module, you will have to specify these settings again.

To **save a newly created configuration on the hard disk of the Windows PC**:

- ▶ In the menu bar, click "Global Menu" > "Save".
The "Save Conference" window appears.

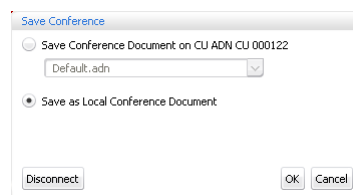

- ▶ Select the "Save as Local Conference Document" option button.
- ▶ Click "OK".
The "Save conference" window appears.

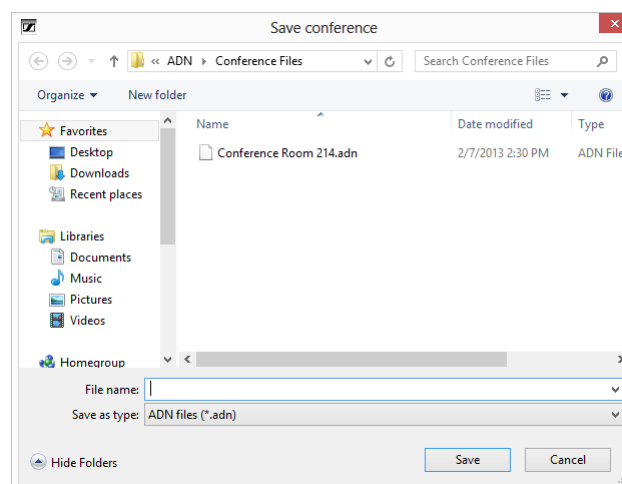

- ▶ Select the desired storage location.
- ▶ Enter a new file name into the "File name" field.
- ▶ Click "Save".
The file is saved.

i By default, the configurations are saved in the "My Documents" folder (Windows XP) or in the "Documents" folder (Windows Vista, 7 or 8) under the "ADN/Conference Files" subfolder.

i You can click "Global Menu" > "Save" to save a configuration that already has a file name; there is no further query.

Saving a configuration under a different file name

To save the current configuration under a different file name:

- ▶ In the menu bar, click "Global Menu" > "Save as...". The "Save Conference" window appears.

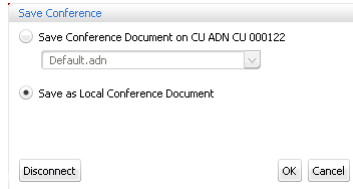

- ▶ Save the current configuration under a different file name (see page 157).

Closing a configuration

- ▶ In the menu bar, click "Global Menu" > "Close". The configuration is closed.

Deleting a configuration from the central unit

- ▶ In the menu bar, click "Global Menu" > "Delete". The "Delete Conference" window appears.

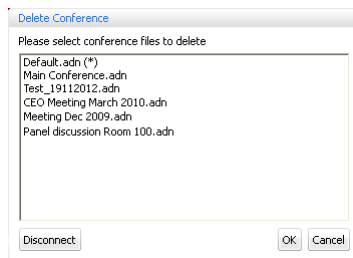

- ▶ Select a configuration.
- ▶ Click "OK". After a confirmation prompt, the selected file is deleted.

i The configuration of an active conference (marked with an asterisk "*"*) and the default file name ("Default.adn") cannot be deleted.

i Configurations saved on the hard disk of a PC can be deleted using the Windows Explorer.



Configuring the settings for wireless conferencing

In order for you to be able to configure the settings for wireless conferencing, the ADN-W AM antenna module(s) must be connected to the central unit and must be ready for operation (see “Connecting the ADN-W AM antenna module to the ADN CU1 central unit” on page 66). Please note that [all](#) the settings for wireless conferencing can only be configured using the “Conference Manager” software in “Live” operating mode (see “Controlling and monitoring a conference – “Live” operating mode” on page 203).

In “Setup” operating mode (and when a connection to the central unit is established), you can view the current settings for the antenna module and make modifications to the settings. Please note, however, that these modifications take effect only when you start “Live” operating mode.

i For wireless conferencing, the settings “[Channel Selection - Manual](#)” and “[Output Power](#)” are saved directly in the connected ADN-W AM antenna module. These settings are not saved in a configuration file of the “Conference Manager” software. If you replace the antenna module, you will have to specify these settings again.

Calling up the general radio settings

- ▶ Activate “Live” operating mode (see “Controlling and monitoring a conference – “Live” operating mode” on page 203).
- ▶ Click the  icon (“Wireless Settings”) on the toolbar. The “[Wireless Settings](#)” window appears. The general wireless settings  are displayed.

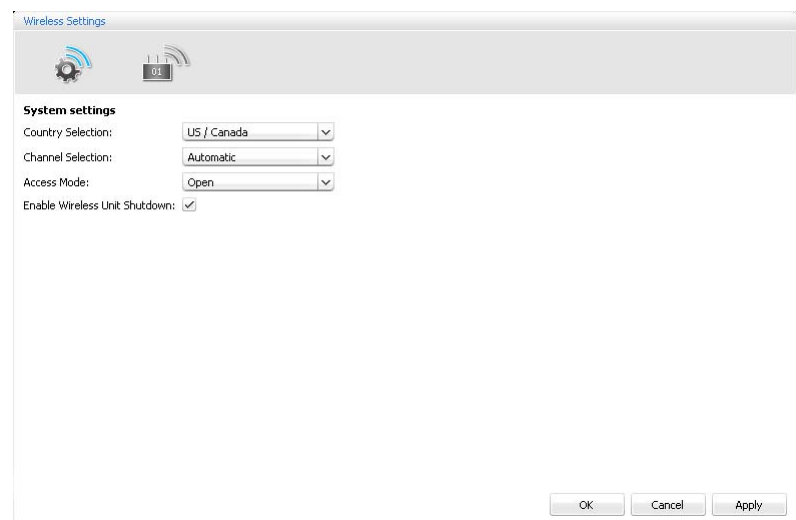

Selecting the country-specific settings – “Country Selection”

i If you are using the ADN-W AM-US antenna module that is designed for the North American market, you cannot change the country-specific settings. The conference system only uses frequencies and transmission powers that are approved for the North American market and all other regions.

To adapt the conference system to the respective country-specific regulations for radio systems:

CAUTION

Risk of violation of legal requirements!

If you are using radio frequencies and transmission powers that cannot be used license-free in your country, there is a risk of violation of legal requirements.

- ▶ Use only radio frequencies and transmission powers that are approved and legal in your country.
- ▶ From the “Country Selection” drop-down list, select the correct country/region in which the conference system is to be used.



- ▶ From the “Country Selection” drop-down list, select the country/region in which the conference system is to be used. Possible settings: “Europe”, “US/Canada” [factory default], “Mexico”, “Japan”, “People’s Republic of China”, “Russian Federation”, “Turkey”, “Australia & New Zealand”, “United Arab Emirates”
- ▶ Click “Apply” or “OK”. When in “Live” operating mode, the conference system then only uses frequencies and transmission powers that are approved and legal in the selected country/region (see “RF channels and transmission powers for wireless conferencing” on page 251).



In some countries/regions (e.g. Canada), the use of wireless components operating in the 5.15 to 5.25 GHz frequency band (channel 5 to 8) is restricted to indoor use.



The country-specific settings for the United States of America and Canada, “US/Canada”, are the most restrictive radio settings of the conference system. These settings are the factory defaults.

Setting the RF channel – “Channel Selection”

You can either activate automatic channel selection, i.e. the conference system automatically selects the RF channels (dynamic frequency management) or you can manually select an RF channel. To ensure safe and reliable operation of the conference system, we recommend that you use automatic channel selection ([Channel Selection – Automatic](#)). Otherwise you have to permanently monitor the wireless components and to manually intervene in case of interference, which will interrupt the conference.

CAUTION

Danger of intermodulation!

If you manually select the RF channel, both the RF signals of the conference system and the RF signals of other devices can be subject to interference.

- ▶ Make sure that the manually selected RF channel cannot be used by other devices or be subject to interference.
- ▶ Only select RF channels that are available for use (see “Manual channel selection” on page 162).

Automatic channel selection



To **automatically** select an RF channel (dynamic frequency management):

- ▶ Select “Automatic” from the “Channel Selection” drop-down list.
- ▶ Click “Apply” or “OK”. The conference system automatically selects the RF channels and permanently monitors the wireless components. The system automatically switches to unused RF channels in case of interference.

To view the RF channel used (only possible in "Live" operating mode):



- ▶ Click the antenna module icon in the "Wireless Settings" window. The overview of the antenna module settings is displayed. The RF channel used is highlighted in blue.



Manual channel selection

To manually select an RF channel (only possible in "Live" operating mode):







- ▶ Select "Manual" from the "Channel Selection" drop-down list.

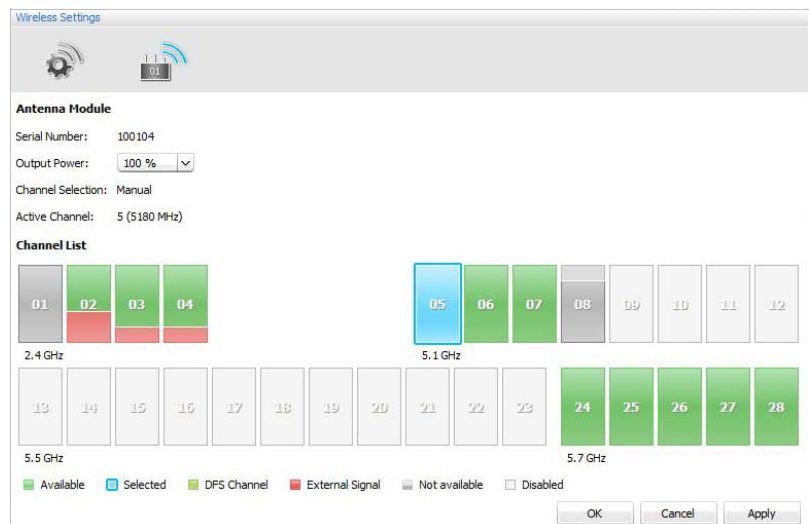

- ▶ Click the antenna module icon in the "Wireless Settings" window. The antenna module scans all frequency ranges and permanently monitors them. The overview of the antenna module settings and of the RF channels is displayed.

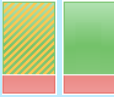

- ▶ Select the desired frequency range (it might be that not all frequency channels can be selected during the cyclic scanning procedure). The selected frequency range is highlighted in blue. The antenna module only uses the selected frequency range.

Channel	Color	RF activity	Usable
	blue	currently set RF channel	–
	green	no RF activity on the respective RF channel	yes
	green-yellow striped	no RF activity on the respective DFS channel; possible RF activity due to primary user (see information box below)	yes, when there is no primary user
	red	slight RF activity on the respective RF channel	yes
	gray	RF channel is occupied; no information available on the RF activity	no
	white	RF channel is not available due to the current country selection	no



A table with all the adjustable frequencies and the exact GHz can be found in the appendix (see page 251).



DFS channels – Dynamic Frequency Selection

DFS channels are unlicensed frequencies in the 5.260 to 5.825 GHz frequency band that can be occupied by authorized primary users.

If one of the DFS channels is used by a primary user (e.g. radar), this channel cannot be used by the ADN conference system for at least 30 minutes. However, with both manual and automatic channel selection, the ADN conference system automatically switches to an alternate channel. Upon expiry of the legal time frame (30 minutes to 24 hours), the ADN conference system will check if the initially selected DFS channel is again available and will use it if needed.

To apply the settings for manual channel selection:

- ▶ Click "Apply" or "OK".

The settings are applied and saved directly in the antenna module.

Setting the RF signal strength – "Output Power"

The maximum possible RF signal strength depends on the currently set country-specific settings for radio systems (see "Selecting the country-specific settings – "Country Selection"" on page 160). This setting can only be made when "Live" operating mode is activated.



- ▶ Click the antenna module icon in the "Wireless Settings" window. The overview of the antenna module settings is displayed.

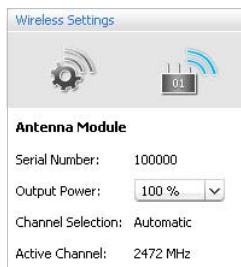

- ▶ Select the desired RF signal strength from the "Output Power" drop-down list:

"Output Power" display	Meaning
"100%" - "20%"	RF signal strength (in percent) – depending on the selected country-specific settings for radio systems (see page 160)
"0%"	All RF functions of the antenna module are switched off. All wireless conference units that were previously connected to the antenna module automatically switch off after 5 minutes.

i An output power of 100% ensures the best possible transmission range of the wireless components and also increases the RF signal quality, especially when the wireless conference units are placed at a large distance from the antenna module.

To apply the settings for the RF signal strength:



- ▶ Click "Apply" or "OK".
The antenna module only uses the selected RF signal strength (in "Live" operating mode). This setting is saved directly in the antenna module.

Logging in the wireless conference units to the conference system – "Access Mode"

There are different options for logging-in the wireless conference units to the conference system:

- Automatic log-in to an open wireless conference system ("Access Mode - Open")
All wireless conference units that are ready for operation automatically connect to the antenna module and can be used instantly. This access mode should be used if only one wireless conference system is in use and if the default eavesdropping protection is sufficient.
- Manual log-in to a closed wireless conference system ("Access Mode - Closed")
Only wireless conference units whose serial numbers are listed in a participant list can be used in the wireless conference. If several wireless conferences are held simultaneously, the closed access mode ensures that the wireless conference units connect to the correct conference system. This access mode increases the protection against eavesdropping because only selected and enabled wireless conference units can be used.

Calling up the settings for logging in the wireless conference units

- ▶ Activate "Live" operating mode (see "Controlling and monitoring a conference – "Live" operating mode" on page 203).
- ▶ Click the  icon on the toolbar.
The "Wireless Settings" window appears. The general wireless settings  are displayed.

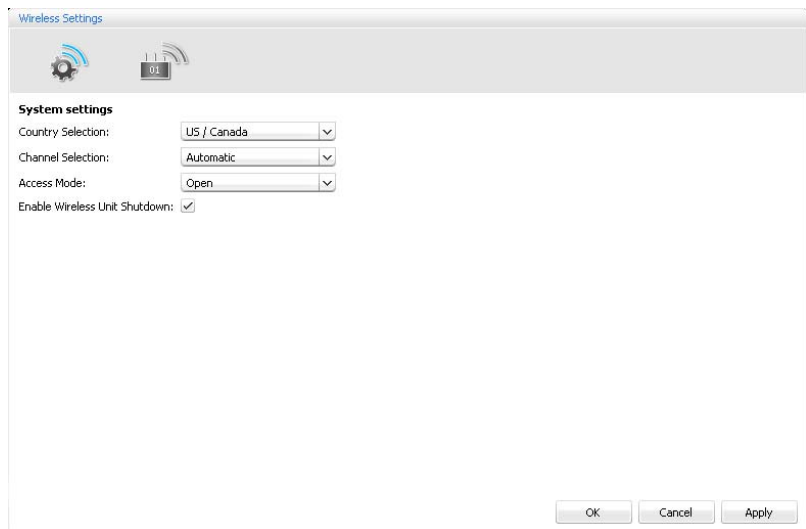

Automatically logging in the wireless conference units (open wireless conferencing) – "Access Mode - Open"

CAUTION

Intermodulation during conferencing!

If several open wireless conferences are held simultaneously ("Access Mode - Open"), intermodulation will occur because the conference units communicate with the antenna modules of the different conference systems.

- ▶ In this case, manually log in the wireless conference units to the correct antenna module (see "Manually logging in the wireless conference units (closed wireless conferencing) – "Access Mode - Closed"" on page 167).



-
- ▶ Select "Open" from the "Access Mode" drop-down list.

- ▶ Click "Apply" or "OK".

After switch-on, all wireless conference units within the transmission range automatically connect to the antenna module and are ready for operation.

-  A list of the automatically logged-in wireless conference units is shown in the Delegate View window (see page 206).

Manually logging in the wireless conference units (closed wireless conferencing) – "Access Mode - Closed"



- ▶ Select "Closed" from the "Access Mode" drop-down list. The participant list containing the wireless conference units to be used in the closed wireless conference system appears below the drop-down list.

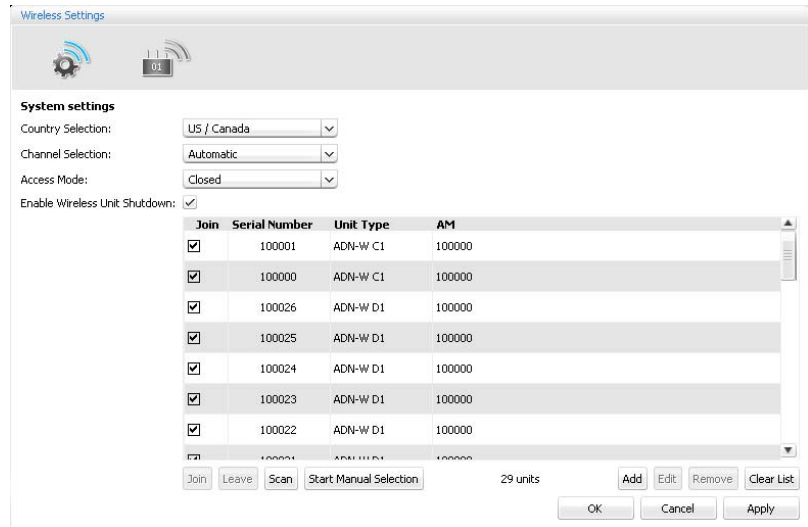

Conference units that are listed in the participant list and whose "Join" check box is ticked are enabled and can be used in a closed wireless conference system. All other wireless conference units change to initialization mode and switch off after approx. 5 minutes.

Reading in wireless conference units and enabling them



To read in all wireless conference units within the transmission range and to enable them for use in a closed wireless conference system:

CAUTION

Interruption of a running conference!

If – during a running conference – you read in all wireless conference units within the transmission range in order to enable them for use in the closed wireless conference system, the conference will be interrupted.

- ▶ Inform the participants that the conference is interrupted and that they might have to make a new request to speak.

- ▶ Make sure that all wireless conference units to be used in the closed wireless conference system are switched on.
- ▶ Click "Scan". All switched-on wireless conference units within the transmission range are added to the participant list and enabled.

Manually selecting wireless conference units and enabling them



To manually select wireless conference units and to enable them for use in a closed wireless conference system:

CAUTION

Interruption of a running conference!

If – during a running conference – you read in all wireless conference units within the transmission range in order to enable them for use in the closed wireless conference system, the conference will be interrupted.

- ▶ Inform the participants that the conference is interrupted and that they might have to make a new request to speak.

- ▶ Make sure that all wireless conference units to be used in the closed wireless conference system are switched on.

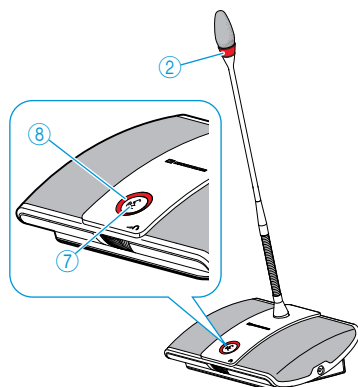

Making individual conference units available or unavailable for use in a close wireless conference system



- ▶ If necessary, click "Clear List" to clear existing entries from the participant list.
- ▶ Click "Start Manual Selection".
The microphone LED ⑧ and the signal light ring ② of all switch-on wireless conference units within the transmission range flash red.
- ▶ Press the microphone key ⑦ of the conference units that you want to add to the participant list.
The microphone LED ⑧ and the signal light ring ② go off. The wireless conference unit is enabled for use in the closed conference system and is added to the participant list.
- ▶ Repeat this procedure for all wireless conference units that are to be enabled for use in the closed wireless conference system.

- i** Make sure that no conference units are accidentally enabled for closed wireless conferencing.
 - ▶ Check the participant list to make sure that only wanted conference units are enabled for closed wireless conferencing.

If the participant list already contains entries (e.g. if you have read in all wireless conference units via the "Scan" function), you can make individual conference units available or unavailable for use in a close wireless conference system:

- ▶ Select one or several entries from the participant list.

- i** To multi-select individual entries throughout the participant list, hold down the CTRL key while selecting using the mouse.

To select a range of adjacent entries, hold down the SHIFT key and select the first and last entry in the list using the mouse.

To make your selection available for use in a close wireless conference system:

- ▶ Click "Join".
The corresponding check boxes in the "Join" column are ticked. The conference units are enabled for use in the closed wireless conference system.



Join	Serial Number	Unit Type	AM
<input checked="" type="checkbox"/>	100001	ADN-W C1	100000
<input checked="" type="checkbox"/>	100000	ADN-W C1	100000
<input checked="" type="checkbox"/>	100026	ADN-W D1	100000

To make your selection unavailable for use in a close wireless conference system:

- ▶ Click "Leave".
The corresponding check boxes in the "Join" column are unticked. The conference units are no longer enabled for use in the closed wireless conference system.



Join	Serial Number	Unit Type	AM
<input checked="" type="checkbox"/>	100001	ADN-W C1	100000
<input type="checkbox"/>	100000	ADN-W C1	100000
<input checked="" type="checkbox"/>	100026	ADN-W D1	100000

Adding a conference unit by entering the serial number

You can easily and safely add additional conference units to a closed conference system or replace an existing conference unit without interrupting the conference by simply manually entering the serial number of a conference unit (see page 121):



- ▶ Click "Add".
The "Conference Participant" window appears.

- ▶ Tick/untick the "Join" check box:

Setting	Enabling for use in a closed wireless conference system
activated Join: <input checked="" type="checkbox"/>	After joining the participant list, the conference unit is immediately enabled for use in a closed wireless conference system.
deactivated Join: <input type="checkbox"/>	After joining the participant list, the conference unit is not yet enabled for use in a closed wireless conference system.

- ▶ In the "Serial Number" text field, enter the last 6 digits of the serial number of the wireless conference unit that you want to add to the closed wireless conference system.

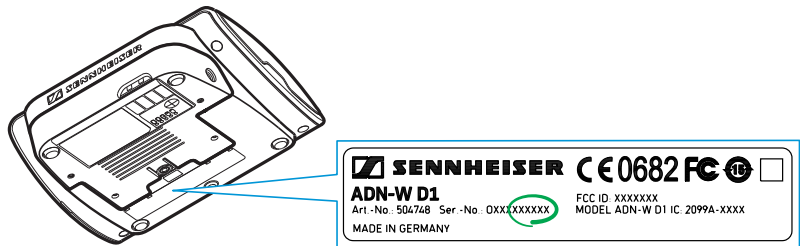

- ▶ Select the correct conference unit type from the "Unit Type" drop-down list ("ADN-W C1" chairperson unit or "ADN-W D1" delegate unit).
- ▶ Click "OK".
The "Conference Participant" window is closed and the conference unit is added to the participant list for closed wireless conferencing.

i If the serial number entered does not correspond to the serial number of the conference unit that is to be added to the conference system, the new entry appears nevertheless in the participant list. The conference unit, however, cannot be enabled for use in a closed wireless conference system.

Editing conference units in or removing conference units from the participant list



To **edit** an entry in the participant list:

- ▶ Select one or several entries from the participant list.
 - ▶ Click “**Edit**”.
- The “**Conference Participant**” window appears.

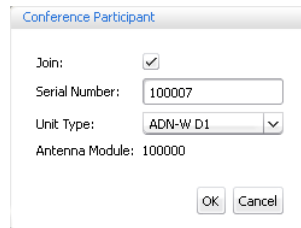

- ▶ Edit the entry as desired.

i If you have selected several entries, you can only edit settings that are applicable to all selected entries.

To **remove** one or several entries from the participant list:

- ▶ Select one or several entries from the participant list.
- ▶ Click “**Remove**”.



The selected entries are removed after a confirmation prompt.

i To multi-select individual entries throughout the participant list, hold down the **CTRL** key while selecting using the mouse.

To select a range of adjacent entries, hold down the **SHIFT** key and select the first and last entry in the list using the mouse.

Clearing the participant list



To **clear** the **entire participant list**:

- ▶ Click “**Clear List**”.
- All entries in the participant list are cleared after a confirmation prompt.

Applying the settings for closed wireless conferencing

To apply the settings for closed wireless conferencing:

- ▶ Click “**Apply**” or “**OK**”.
- Conference units that are listed in the participant list and whose “**Join**” check box is ticked are enabled and can be used in a closed wireless conference system. All other wireless conference units change to initialization mode and switch off after approx. 5 minutes.

Deactivating manual switch-off of the wireless conference units – “Enable Wireless Unit shutdown”

To prevent accidental switch-off of the wireless conference units, you can deactivate the manual switch-off function (see page 79).

- ▶ Tick/untick the “Enable Wireless Unit Shutdown” check box:



Setting	Manual switch-off of the wireless conference units
activated <input checked="" type="checkbox"/> Enable Wireless Unit Shutdown:	Individual conference units can be switched off manually by pressing the microphone key for 5 seconds (see page 79).
deactivated <input type="checkbox"/> Enable Wireless Unit Shutdown:	Individual conference units can no longer be switched off manually.

- ▶ Click “Apply” or “OK”.
The wireless conference units can be switched off as set.

i The “Enable Wireless Unit Shutdown” is also deactivated in “Push to talk” mode.

Preparing a conference and mapping a conference room – "Setup" operating mode

In "Setup" operating mode, you can use photos and graphical elements to map a conference room. Using participant lists, you can clearly assign conference units to conference participants and then monitor and control your conference.

Example of a photographical representation of the conference room (for how to use image files, see page 178):



Example of a graphical representation of the conference room (for how to place graphic objects on the canvas, see page 174):

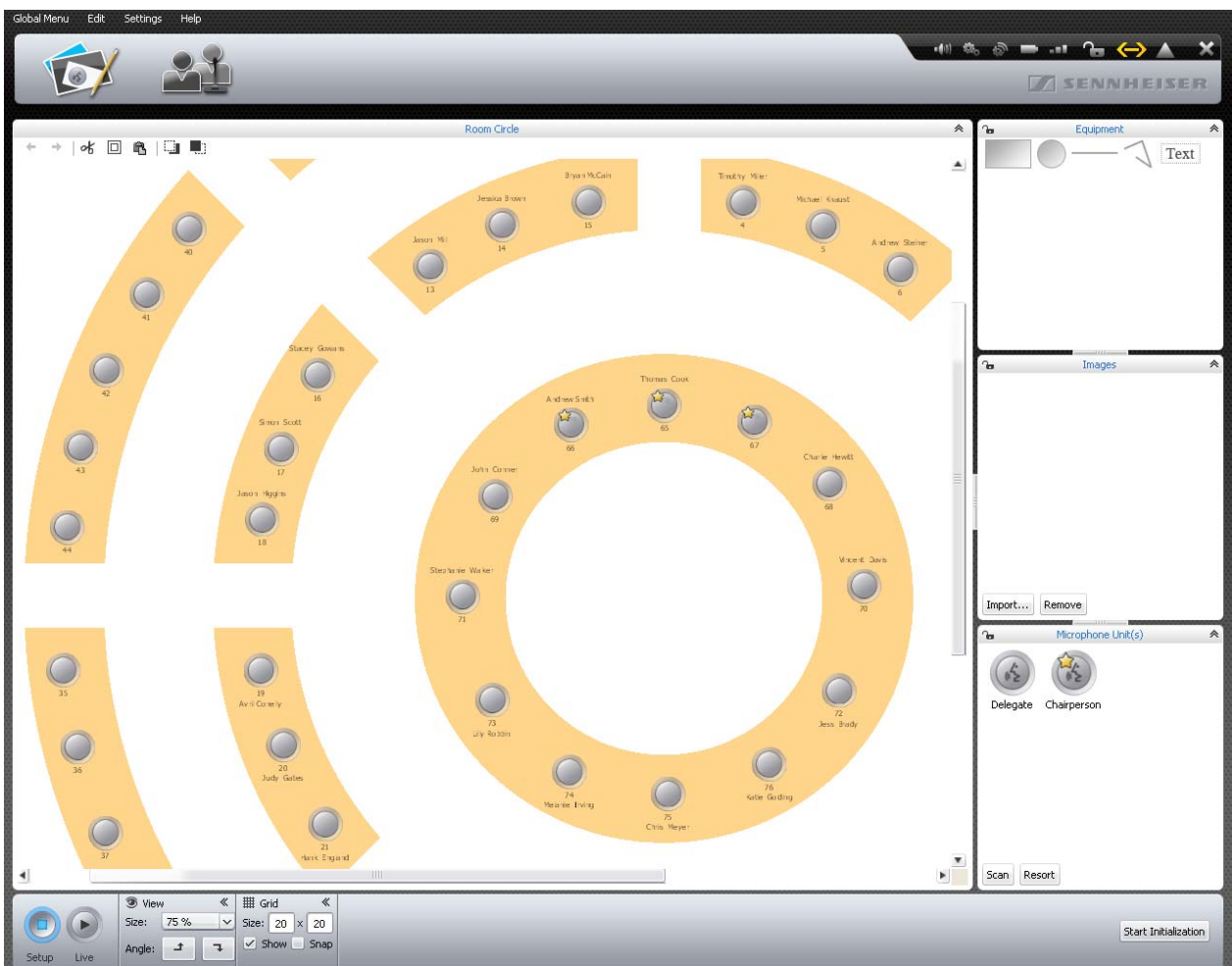

Example of a participant list (for how to create a participant list, see page 184):

ID	First Name	Last Name	Chairperson	Show	Color	Room Circle	RF Status	Battery Status	Serial Number
65	Thomas	Cook	★	✓	Green	AM			-00001
66	Andrew	Smith	★	✓	Green				-00001
19	Avril	Conelly		✓	Cyan				-00001
21	Hank	England		✓	Cyan				-00001
68	Charlie	Hewitt		✓	Cyan				-00001
75	Chris	Meyer		✓	Cyan				-00001
12	David	Porter		✓	Cyan				-00001
1	Bruce	Wayne		✓	Cyan				-00001
3	Charles	Williams		✓	Cyan				-00001
9	Jessica	Barry		✓	Red				-00001
72	Jess	Brady		✓	Red				-00001
69	John	Conner		✓	Red				-00001
7	Michael	Cullen		✓	Red				-00001
70	Vincent	Davis		✓	Red				-00001
22	Mariah	Deaner		✓	Red				-00001
20	Judy	Gates		✓	Red				-00001
76	Katie	Golding		✓	Red				-00001
18	Jason	Higgins		✓	Red				-00001
2	Liz	Huston		✓	Red				-00001
74	Melanie	Iving		✓	Red				-00001
11	Terry	Kerr		✓	Red				-00001
10	Jean	McConnell		✓	Red				-00001
73	Lilly	Robbin		✓	Red				-00001
24	Jason	Thorn		✓	Red				-00001
71	Stephanie	Walker		✓	Red				-00001
8	Jennifer	Watson		✓	Red				-00001
14	Jessica	Brown		✓	Magenta				-00001
16	Stacey	Gowans		✓	Magenta				-00001
5	Michael	Knaust		✓	Magenta				-00001
15	Bryan	McCain		✓	Magenta				-00001
23	Toni	McRollins		✓	Magenta				-00001
13	Jason	Mill		✓	Magenta				-00001
4	Timothy	Miller		✓	Magenta				-00001
17	Simon	Scott		✓	Magenta				-00001
6	Andrew	Steiner		✓	Magenta				-00001



Planning and mapping the conference room

Placing objects on the canvas

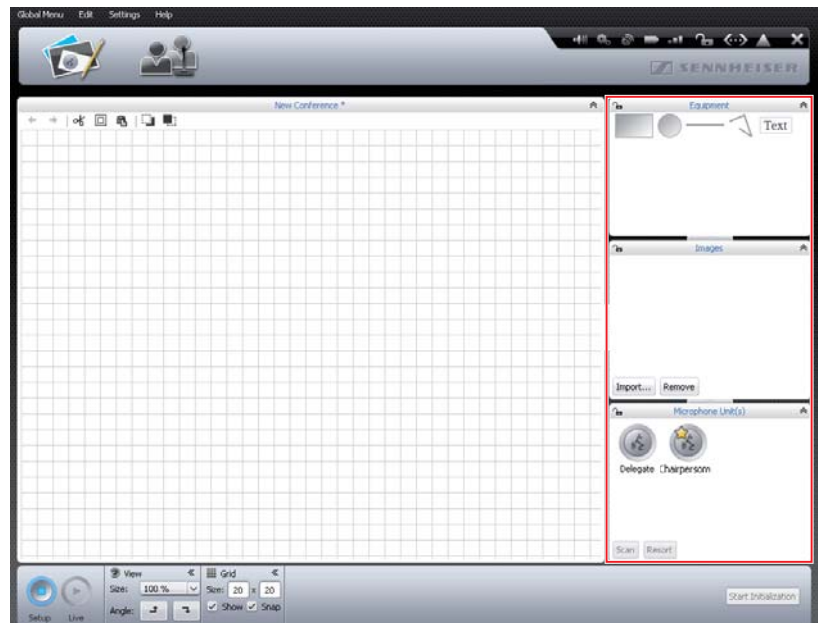
▶ Click the Room View button .





- ▶ Select an object from the "Equipment", "Images" or "Microphone Unit(s)" library panels. The selected object is highlighted in blue.
- ▶ Drag the object onto the canvas.
If the object can be dropped at the current cursor position, the object and the  icon are displayed next to the mouse pointer. If the object cannot be dropped at the current cursor position, the  icon is displayed.
- ▶ Drop the object at the desired position.
The object is placed on the canvas in standard size.

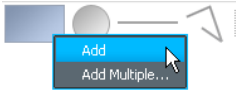

- You can also place rectangles and circles as follows:
- ▶ Right-click the desired object.
The context menu of graphic objects appears.
 - ▶ Click "Add".
The object is placed in the center of the canvas.



You can predefine the color and border of the graphic objects so that the placed objects already have the desired properties (see "Defining fill, line and border attributes" on page 176).

Placing several objects on the canvas

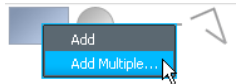

- To place several rectangles or circles on the canvas:
- ▶ Right-click the desired object.
The context menu of graphic objects appears.
 - ▶ Click "Add Multiple...".
The "Add Equipment" window appears.

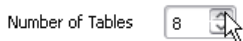
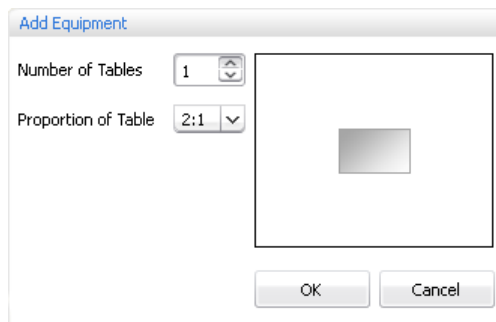

- ▶ Enter the desired number of rectangles or circles into the "Number of Tables" field.
- ▶ Select the shape of the rectangles or circles from the "Proportion of Table" drop-down list.
The thumbnail displays the selected shape.

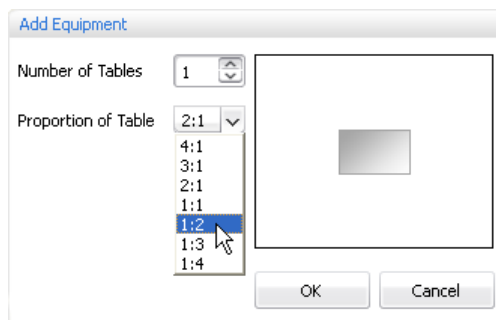

- ▶ Click "OK".
The desired number of rectangles or circles is placed on the canvas.



Newly placed objects can cover existing objects. In this case, change the order of the objects by sending them to the front or back (see page 182).

Creating and positioning a freeform path



- ▶ In the "Equipment" library panel, select the Freeform Path tool and place it on the canvas (see page 174). The starting point of the freeform path is set.
- ▶ Use mouse clicks to add anchor points to the freeform path.
- ▶ Double-click the last anchor point of the path. The freeform path is complete.

Moving graphic objects

- ▶ Select the desired object on the canvas. The object appears with a bounding box (dashed line) around it. Objects that cannot be selected are locked (see page 184).
- ▶ Move the object to the desired position.



If you want to move several objects simultaneously, position the mouse pointer on the canvas, then click and hold down the left mouse button while you draw a box around the objects to be moved. Alternatively, hold down the "CTRL" key and click the desired objects one after the other.

You can also select all objects on the canvas by clicking "Edit" > "Select all" in the menu bar (or by pressing the key combination "CTRL" + "a").

You can use the grid lines to align the objects (see page 183).

Resizing graphic objects

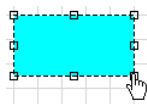

- To resize rectangles, circles, lines or paths:
- ▶ Select the desired object on the canvas. The object appears with a bounding box (dashed line) and bounding box handles around it.
 - ▶ Place the mouse pointer on the desired bounding box handle. The mouse pointer changes to a hand icon.
 - ▶ Resize the object as needed.

Rotating objects

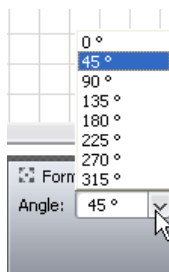

- ▶ Select the desired object on the canvas. The selected object is outlined with a dashed line. The "Form" box appears.
 - ▶ Select the desired rotation angle from the "Angle" drop-down list.
- Or:
- ▶ Enter the desired rotation angle into the "Angle" drop-down list box.

Defining fill, line and border attributes

Please note when defining fill, line and border attributes:

If you select an object [in the library panel](#) and then define fill, line and border attributes, the defined attributes apply to all newly created objects of this type.

If you select an object already placed [on the canvas](#) and then define fill, line and border attributes, the defined attributes only apply to the selected object on the canvas.

Defining the fill color

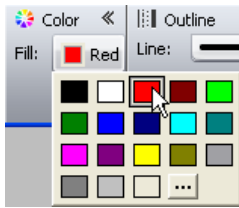

To define the fill color:

- ▶ Select the object.
- ▶ In the "Color" box, click the "Fill" button. The list of colors appears.
- ▶ Select a standard color.
- Or:
 - ▶ Click the  button. The "Select color" window appears.
 - ▶ Select an individual color.
 - ▶ Click "OK". The fill color is assigned to the selected object or to all newly created objects (see above).

To add an individual color to the list of default colors:

- ▶ Select the desired color in the "Select color" window.
- ▶ Click "Add to Custom Colors". The color is added to the list of default colors.

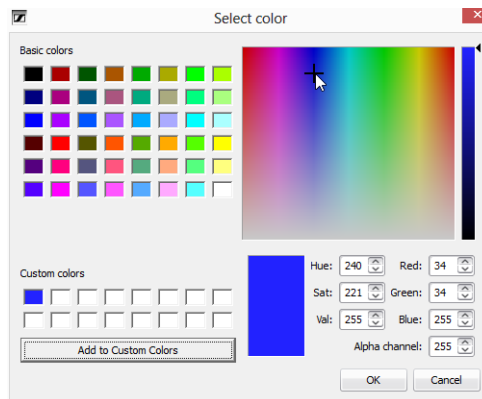

Changing the line and border style and color

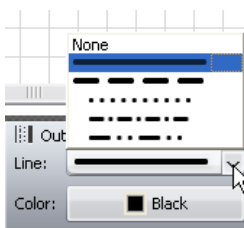

To define the line or border style:

- ▶ Select the object.
- ▶ Click on the "Line" drop-down list. The list of available line styles appears.
- ▶ Select a line type. The line style is assigned to the selected object or to all newly created objects (see above).

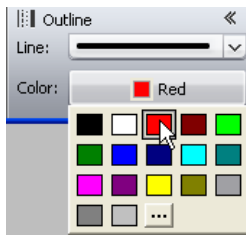

To define the line color:

- ▶ Select the object.
- ▶ Click the "Color" button.
- ▶ Select a default color.

Or:

- ▶ Click the button. The "Select color" window appears.
- ▶ Select a color.
- ▶ Click "OK".

The line or border color is assigned to the selected object or to all newly created objects (see "Defining fill, line and border attributes" on page 176).

Placing text on the canvas



- ▶ Select the "Text" text object tool in the "Equipment" library panel and drag it onto the canvas. The text object is placed on the canvas.
- ▶ Double-click the text object.
- ▶ Enter the desired text.

Changing the font type



- ▶ Select the desired text object on the canvas. The text object appears with a bounding box (dotted line) around it. The "Font" box appears.
- ▶ Select the desired font from the "Font" drop-down list. The font of the text object is changed.

If a configuration file uses a font not installed on the central unit, this font is automatically replaced with the "Microsoft Sans Serif" font.

Changing the font size



- ▶ Select the desired text object on the canvas. The text object appears with a bounding box (dotted line) and bounding box handles around it.
- ▶ Place the mouse pointer on the desired bounding box handle. The mouse pointer changes to a hand icon.
- ▶ Drag the bounding box handle to resize the font size.

Using image files

To particularly realistically simulate the conference situation, you can import image files of you conference room into the software. You can then position conference unit icons exactly where the conference participants are seated and you can also position pictures of the participants or company logos.

Image files can only be imported when you are using the Windows version of the software (see next section).

- ▶ Click the Room View button .

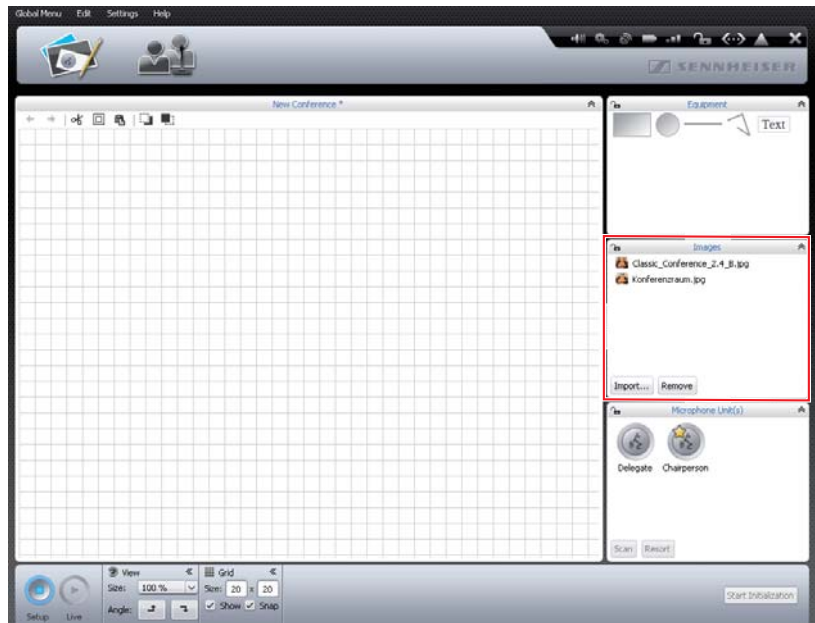

To add an image file:^{*}

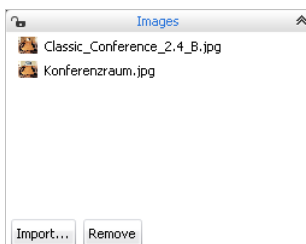

- ▶ In the "Images" library panel, click "Import...". The "Import..." window appears.
- ▶ Select an image file (file extension: ".jpg", ".png" or ".bmp").
- ▶ Click "OK".

The selected image file is added to the library. If you save the configuration on the central unit (see page 157), all image files are copied and are then also available on the central unit. Image files with a resolution of more than 2048 pixels in width are automatically reduced to 2048 pixels.



i The picture of the conference room should meet the following requirements:

- Each seat should be clearly visible.
- Each seat should have enough space for a conference unit icon.
- Use the perspective on the conference room that the conference manager, e.g. the chairperson, will have.
- If possible, use a bird's-eye perspective, providing the conference manager with a good view of the conference room.
- Avoid using dark pictures so that the conference unit icons are always clearly visible on the screen.

i Please note that the memory space on the central unit is limited (approx. 2 GB). To save memory space, delete image files that are no longer needed.

By default, the image files are saved in the "My Documents" folder (Windows XP) or in the "Documents" folder (Windows Vista, 7 or 8) under the "ADN/Images" subfolder.

^{*} only if you are using the Windows version of the software

To remove image files from the "Images" library panel:*

- ▶ Select an image file.
- ▶ Click "Remove".

Automatically aligning objects

- ▶ Hold down the "CTRL" key and select several objects on the canvas using the mouse. The objects appear with a bounding box (dotted line). The "Alignment" box appears.

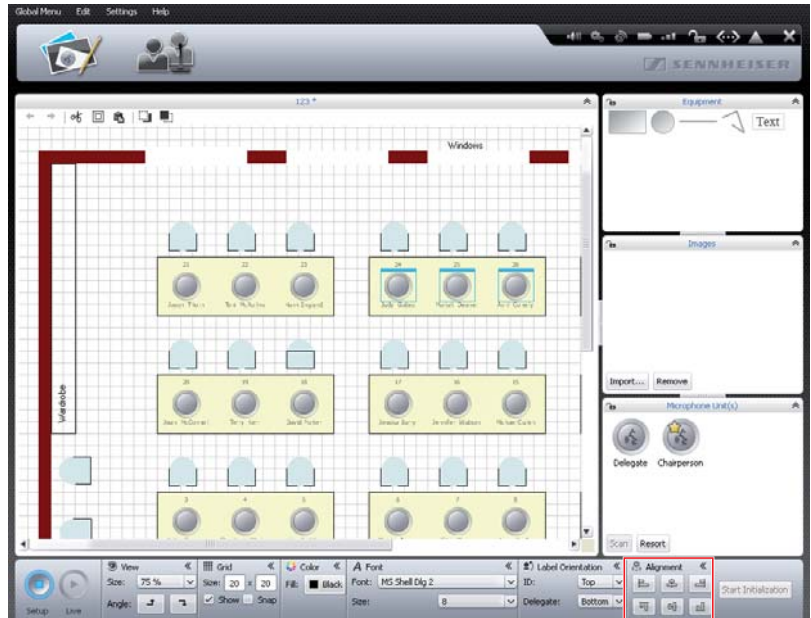

- ▶ In the "Alignment" box, click one of the following buttons:

Button	Objects are aligned to the ...
	left edge
	horizontal center
	right edge
	top edge
	vertical center
	bottom edge

The objects are aligned.

* only if the library of the current configuration contains image files

- Undoing/redoing actions
- ▶ Click the Room View button .

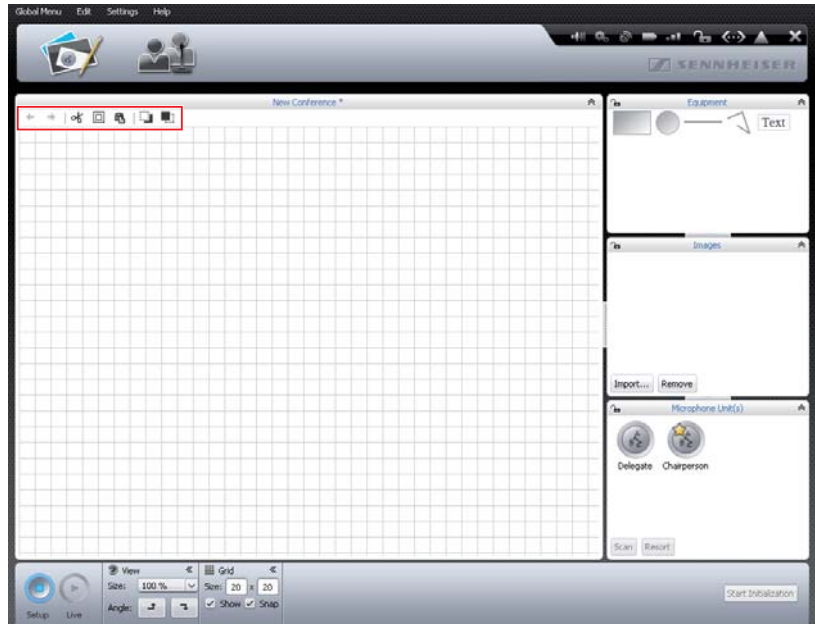

To reverse the last action you performed:

- ▶ Click the  icon.

To reverse the last "undo" action:

- ▶ Click the  icon.



You can undo and redo up to 10 actions.

Copying/pasting/cutting objects



To cut an object and paste it to the clipboard:

- ▶ Select the object that you want to cut and paste.
- ▶ Click the  icon.
The selected object is cut from the canvas and pasted to the clipboard.

To copy an object to the clipboard:

- ▶ Select the object that you want to copy.
- ▶ Click the  icon.
The selected object is copied to the clipboard.

To paste an object from the clipboard:

- ▶ Click the  icon.
The object from the clipboard is pasted to the canvas.

To delete an object:

- ▶ Select the object that you want to delete.
- ▶ Press the "Del" key.
The selected object is deleted.

Moving objects forwards/backwards



All objects on the canvas are placed on top of each other.

To move an object backwards:

- ▶ Select an object.
- ▶ Click the  icon.
The selected object is moved backwards.

To move an object forwards:

- ▶ Select an object.
- ▶ Click the  icon.
The selected object is moved forwards.

Enlarging the canvas

When a new conference document opens in the Room View window, the canvas is the large area with the grid pattern. When you reduce the size of the canvas, you can see that the grid lines of the canvas are surrounded by a white area.

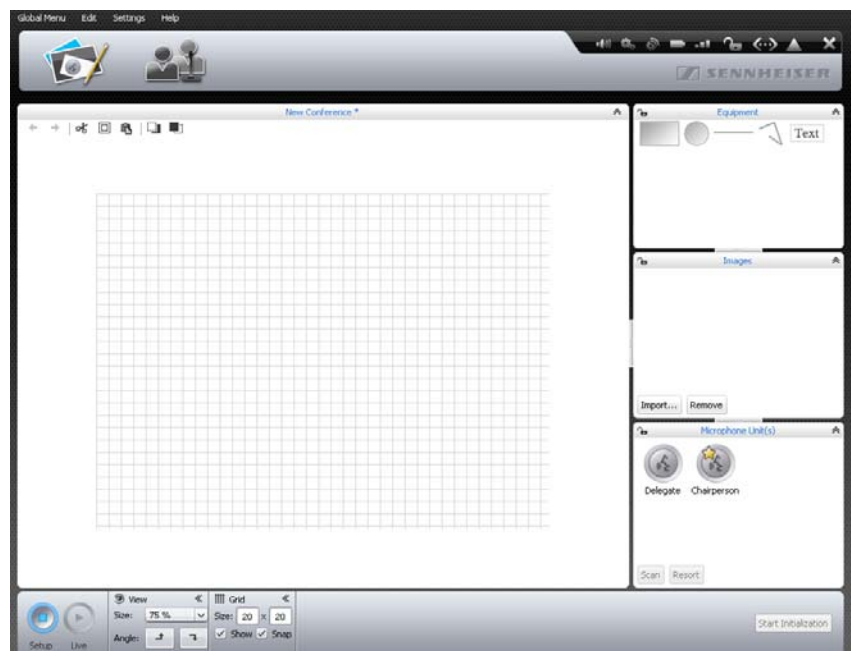

To enlarge the canvas:

- ▶ Move any objects on the canvas beyond the area of the grid lines.
The canvas is automatically enlarged and adjusted to the new position of the objects.



When you remove objects from the enlarged area of the canvas, the canvas is reduced to its normal size.

Changing the size of the canvas and rotating the contents of the canvas

- ▶ Click the Room View button .

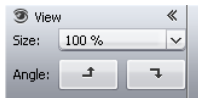
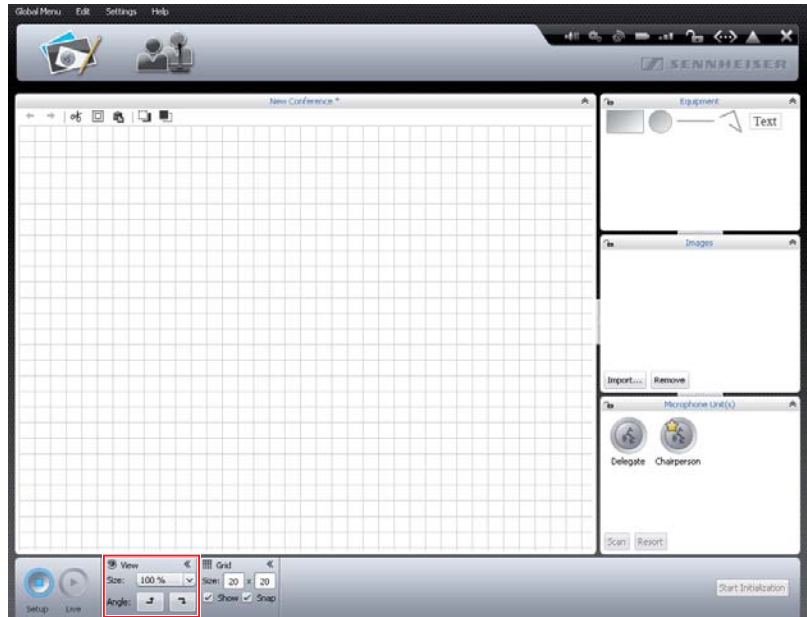

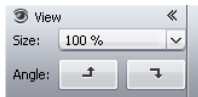

To enlarge/reduce the size of the canvas:

- ▶ Select the desired scaling factor from the "Size" drop-down list. The size of the canvas is adjusted.



To rotate the contents of the canvas:

- ▶ Click  or . The contents of the canvas are rotated by 90°.

 When the contents of the canvas are rotated, the orientation of the text objects does not change so that the text remains readable.

Using grid lines

- ▶ Click the Room View button .

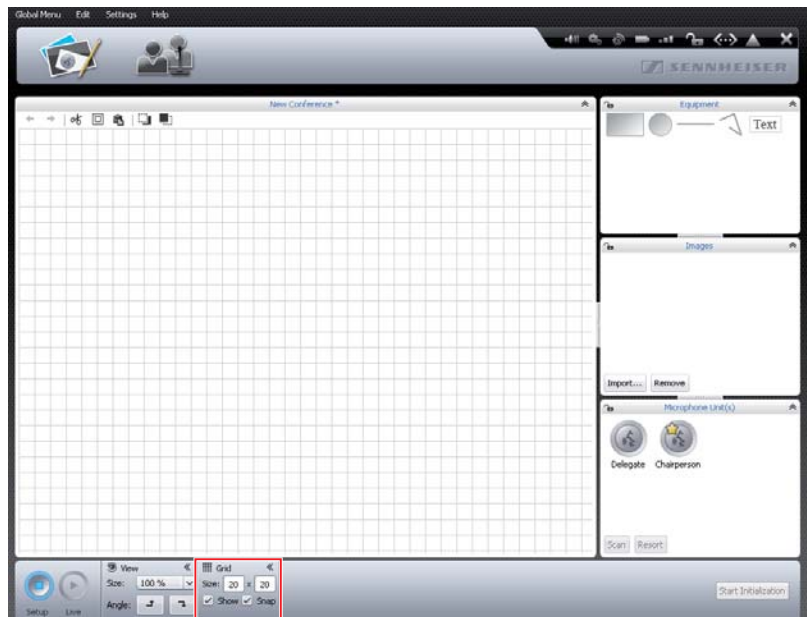



To show/hide the grid lines:

- ▶ Tick/untick the "Show" check box.

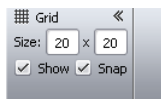

To adjust the grid size:

- ▶ Enter the desired grid size (between 1 and 99) into the "Size" fields. The grid size is adjusted.



To automatically align objects to the grid when you drop them on the canvas:

- ▶ Tick the "Snap" check box.

i If the "Snap" check box is ticked, objects are also aligned to the grid when the grid is invisible.





To randomly place objects on the canvas:

- ▶ Untick the "Snap" check box. All objects can be randomly placed on the canvas on the canvas.

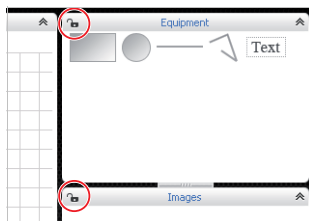

Locking objects and library panels



You can lock all objects in the "Equipment", "Images" and "Microphone Unit(s)" library panels. In doing so, you also lock all objects placed on the canvas so that they cannot be edited.

- ▶ Click the Room View button .
 - ▶ Click the  icon in the header of the library panel that you want to lock. The library panel and the objects are locked (lock icon ).
- You can no longer drag objects from the library panel to the canvas or edit objects that are already placed on the canvas.

To unlock library panels:

- ▶ Click the  icon in the header of the library panel that you want to unlock. The library panel and the objects are unlocked (lock icon .

Managing participant data

You can create a participant list for your conference. You can sort the participant data in your list into groups according to specific criteria and assign conference units to individual names, allowing you to keep track of and securely manage your conference.

Creating a participant list ▶ Click the Delegate View button .

The Delegate View window appears (the screenshot below shows the Windows version of the software which features the additional buttons "Import..." and "Export...").

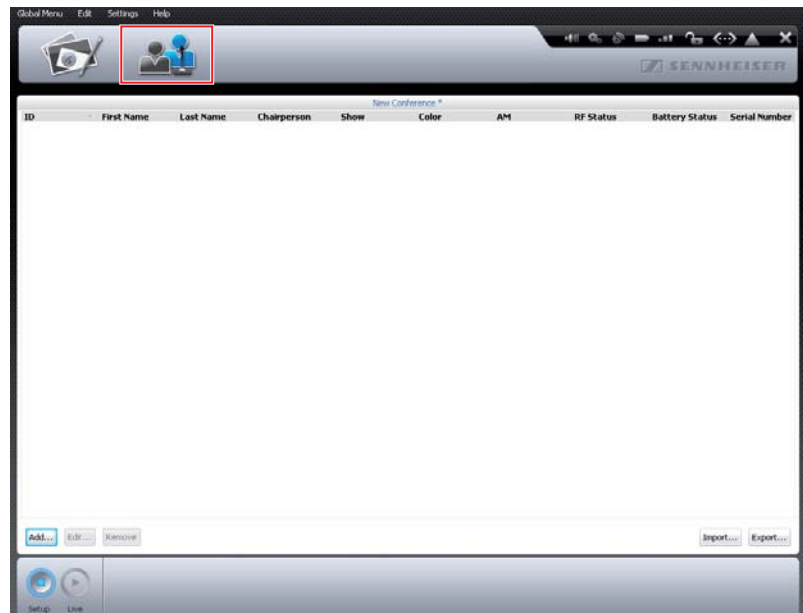

▶ Click the "Add..." button.
The "Delegate" window appears.

To assign an already numbered and initialized conference unit to a participant (only possible, if the conference units have been initialized, see page 189):

▶ Select the number of the conference unit you want to assign from the "Microphone ID" drop-down list.

Or:

▶ Enter the number of the conference unit into the "Microphone ID" field.
Depending on the number of the conference unit, the type of conference unit ("Delegate" or "Chairperson") is displayed behind "Unit Type" after saving.

To enter the first name:

▶ Enter the first name of the participant into the "First Name" field.

To enter the last name:

▶ Enter the last name of the participant into the "Last Name" field.

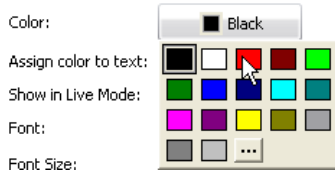

To assign a color to a participant:

- ▶ Click the "Color" button.
- ▶ Select a default color.
- Or:
- ▶ Click the "..." button.
- The "Select color" window appears.
- ▶ Select a color.
- ▶ Click "OK".

To also assign the selected color to the text in the participant list:

- ▶ Tick the "Assign color to text" check box.

8	Jess	Brady		✓	■
9	Katie	Golding		✓	■

Assign color to text:

To display the text in the participant list in black:

- ▶ Untick the "Assign color to text" check box.

8	Jess	Brady		✓	■
9	Katie	Golding		✓	■

Assign color to text:

To show a participant in "Live" operating mode:

- ▶ Tick the "Show in Live Mode" check box.
- The delegate is shown and available in "Live" operating mode.

Show in Live Mode:

To hide a participant in "Live" operating mode:

- ▶ Untick the "Show in Live Mode" check box.
- The participant is hidden and not available in "Live" operating mode. You can use this function to prepare participant lists containing participants who are, for example, not to participate in the next conference.

Show in Live Mode:

To change the font type of the text in the participant list:

- ▶ Select the desired font type from the "Font" drop-down list.

Font:

26	Avril	Conelly		✓	■
3	John	Conner		✓	■

To change the font size of the text in the participant list:

- ▶ Select the desired font size from the "Font Size" drop-down list.

Font Size:

26	Avril	Conelly		✓	■
3	John	Conner		✓	■

To change the line height of the text in the participant list:

- ▶ Select the desired font size from the "Line height" drop-down list.

Line height:

26	Avril	Conelly		✓	■
3	John	Conner		✓	■
4	Stephanie	Walker		✓	■

To save a participant to the participant list with the settings made:

- ▶ Click "OK".
- The window is closed and the participant is displayed in the participant list.

ID	First Name	Last Name	Chairperson	Show	Color
5	Thomas	Cook	★	✓	■
23	Andrew	Smith		✓	■
3	Avril	Conelly		✓	■
27	Bruce	Wayne		✓	■
28	Charles	Williams		✓	■

Changing participant settings

- ▶ Double-click a participant name.

Or:



- ▶ Click the "Edit..." button.*
The "Delegate" window appears, displaying the corresponding participant settings.
- ▶ Change the settings (see page 185).
- ▶ Click "OK".
The window is closed.



If you want to change the settings of other participants in the participant list without having to close the "Delegate" window:

- ▶ Click the "Previous" or "Next" button.



If you want to change several participant entries simultaneously to, for example, assign a specific color to a group of participants:

- ▶ Hold down the "CTRL" key and select several participants from the participant list using the mouse.
- ▶ Right-click the selection.

Or:

- ▶ Click the "Edit..." button.
The "Delegate" window appears.
- ▶ Change the settings you want to assign to the participant group, e.g. the color (see page 185).
- ▶ Click "OK".
The window is closed and the settings are assigned to the participant group.

* only if you are using the Windows version of the software

Sorting participant entries in groups

You can sort the participant entries in your list into groups according to specific criteria:

- ▶ In the participant list, double-click the column header "ID", "First Name", "Last Name", "Chairperson", "Show", "Color", "AM", "RF Status", "Battery Status" or "Serial Number".

The participant list is sorted according to the selected column, e.g. "Color":

ID	First Name	Last Name	Chairperson	Show	Color
1	Andrew	Smith	★	✓	■
2	Thomas	Cook	★	✓	■
7	Chris	Meyer		✓	■
11	Charlie	Hewitt		✓	■
12	Bruce	Wayne		✓	■
14	Charles	Williams		✓	■
18	David	Porter		✓	■
23	Hank	England		✓	■
26	Avril	Conelly		✓	■
3	John	Conner		✓	■
4	Stephanie	Walker		✓	■
5	Lilly	Robbin		✓	■
6	Melanie	Irving		✓	■

- ▶ In "Live" operating mode, you can show and hide the columns in the participant list as you like (see page 150).

Deleting a participant entry

Remove

- ▶ Select a participant entry.
 - ▶ Click the "Remove" button.
- The participant entry is deleted from the participant list.

Exporting a participant list*

Export...

- ▶ Click the "Export..." button.*
- The "Save as..." window appears.
- ▶ Enter a file name.
 - ▶ Select the desired storage location.
 - ▶ Click "OK".
- The window closes and the participant list is exported as an XML file.

- ▶ In "Live" operating mode, you can show and hide the columns in the participant list as you like (see page 150).
- By default, the participant lists are saved in the "My Documents" folder (Windows XP) or in the "Documents" folder (Windows Vista, 7 or 8) under the "ADN/Delegates Lists" subfolder.

Importing a participant list*

You can import a participant list from other configurations:

CAUTION**Loss of participant data!**

If you import a participant list, all existing participant names will be deleted. This action cannot be reversed.

- ▶ Export the existing participant list to save the data for later use (see above).

Import...

- ▶ Click the "Import..." button.
- The "Import Participant data" window appears.
- ▶ Select the XML file with the participant list.
 - ▶ Click "OK".
- The window closes and the participant list is displayed in the Delegate View window.

* only if you are using the Windows version of the software

Initializing the conference units – "Setup" operating mode

In order to assign the wired and wireless conference units connected to the central unit to the conference unit icons in the software, you have to initialize the conference units. By initializing the conference units, you can clearly label the icons and assign them to certain seats or certain conference participants.

You can automatically or manually place wired and wireless conference units on the canvas and initialize them.

CAUTION



Interruption of a running conference!

If you start the initialization of the conference units during a running conference, the conference will be interrupted.

- ▶ Inform the participants that the conference is interrupted and that they might have to make a new request to speak.

Overview of the conference unit icons

The icons display the current status of the conference units. The icons of chairperson units are marked with a star 🌟.

Conference unit icon	Meaning
	The icon has not yet been assigned a conference unit. The conference unit is not ready for operation.
	The icon has been assigned a conference unit. The conference unit is ready for operation.

The icons are the same for wired and wireless conference units. Only after you have initialized the conference units can you get detailed information on the individual icons by hovering the mouse pointer over an icon.

For additional information on the conference unit icons in "Live" operating mode, refer to the chapter "Monitoring a conference" on page 205.

Automatically placing conference units on the canvas and initializing them

- ▶ Set up the conference system (see page 56).
- ▶ Establish a connection between the "Conference Manager" software and the central unit (see page 154).
- ▶ Make sure that all wired and wireless conference units are connected and ready for operation (see page 78).

- ▶ Click the Room View button .

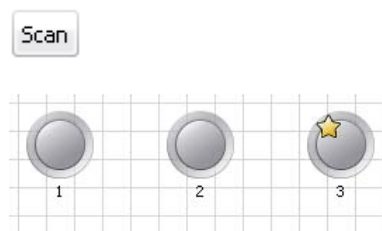
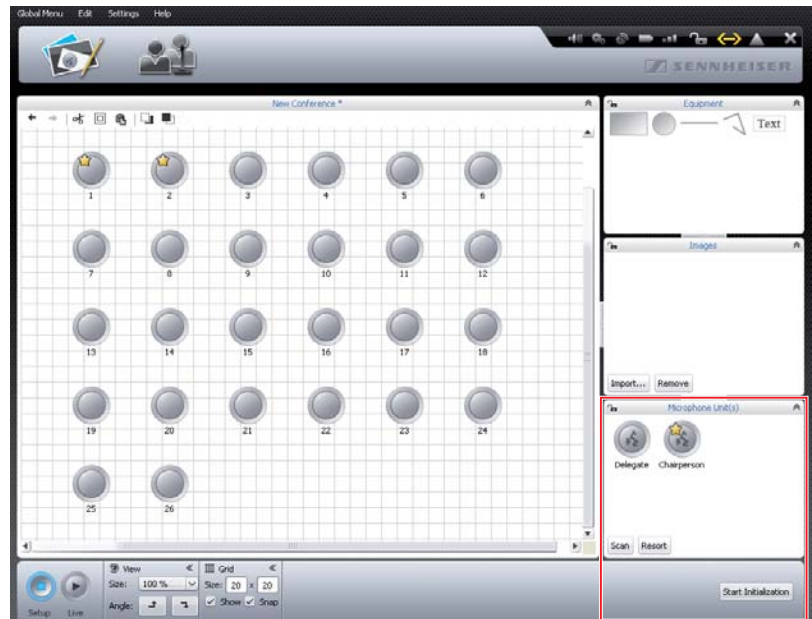

- ▶ In the "Microphone Unit(s)" library panel, click the "Scan" button. The conference unit icons are placed on the canvas and initialized. With wired conference units, the order of initialization corresponds to the physical order of connection to the central unit. With wireless conference units, the order of initialization depends on the type of conference unit and on the serial number. The sequential number of the conference units is displayed below the conference unit icons. The icons of chairperson units are marked with a star .

i If there are already conference unit icons on the canvas, a confirmation prompt appears, telling you that these icons will be deleted. If you do not want to delete these icons, you have to manually place and initialize the conference units (see next section).

Manually placing conference units on the canvas and initializing them

To manually place conference units on the canvas, the software must not be connected to the central unit.



- ▶ In the "Microphone Unit(s)" library panel, select a delegate unit icon or a chairperson unit icon and drag it on the canvas (see page 174). The sequential number of the conference unit is displayed below the icon. As long as the conference units are not yet initialized, a question mark is displayed on the icon.



To enable manually placed conference units for use:

- ▶ Establish a connection between the "Conference Manager" software and the central unit (see page 154).
- ▶ Make sure that all wired and wireless conference units are connected and ready for operation (see page 78).
- ▶ Assign each icon on the canvas a conference unit that is physically connected to the central unit or wirelessly connected to the antenna module (see next chapters).

i During initialization, you can extend or reduced the selection of conference unit icons:

- ▶ Select one or several conference unit icons using the mouse.
- ▶ Right-click the selection and confirm the confirmation prompt by clicking "OK".
The selected conference unit icons are included in or excluded from the initialization.

i If you only want to select and edit conference unit icons, you can lock the graphic objects and pictures that are in the background (see page 184).

Starting the initialization of all conference units



- ▶ Make sure that no conference unit icon is selected.
- ▶ Click the "Start Initialization" button and confirm the confirmation prompt with "OK".

The microphone LEDs ⑧ and the signal light rings ② of the connected wired and wireless conference units light up red. On the canvas, the conference unit icon with the number "1" is permanently marked with a red circle. All other icons are marked with flashing red circles.

Starting the initialization of a selection of conference units



- If you only want to initialize a certain selection of conference units:
- ▶ Select all conference units icons that you want to initialize.
 - ▶ Click the "Start Initialization" button and confirm the confirmation prompt with "OK".

The microphone LEDs ⑧ and the signal light rings ② of the selected and not yet initialized conference units (wired and wireless) flash red. On the canvas, the conference unit icon with the lowest, not yet initialized number is permanently marked with a red circle. All other selected icons are marked with flashing red circles.

To assign a conference unit to the conference unit icon which is permanently marked with a red circle:

- ▶ Press the microphone key ⑦ on the conference unit.
The microphone LED ⑧ and the signal light ring ② of the conference unit go off. The next conference unit icon is permanently marked with a red circle.
- ▶ Repeat this step for the remaining conference units.
The initialization process is complete when all conference units are assigned.

i You can only assign delegate units to delegate unit icons ④ and chairperson units to chairperson unit icons ⑤.

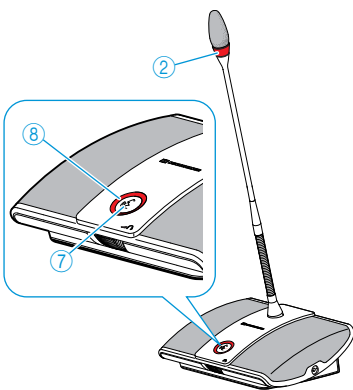

Canceling or stopping the initialization of the conference units



To cancel or stop the initialization:

- ▶ Click the "Stop Initialization" button in the "Microphone Unit(s)" library panel.
- ▶ The "Stop Initialization" window appears.

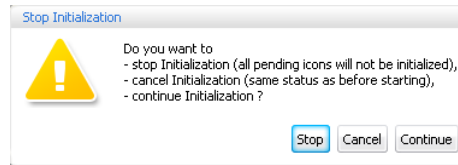

If you want to stop the initialization and not initialize all uninitialized conference units:

- ▶ Click "Stop".

If you want to cancel the initialization and to reverse the changes made:

- ▶ Click "Cancel".

If you want to continue the initialization process:

- ▶ Click "Continue".

Changing the numbering of the conference units



To change the numbering of the conference units:

- ▶ Click the "Resort" button.
The "Resort" button becomes the "Stop Resort" button.
- ▶ Click the conference unit icons in the desired order.
The numbering of the conference unit icons is changed.

i If, during numbering, you realize that you require further conference unit icons, just place them on the canvas. The numbering process is not interrupted.

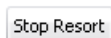

To stop the numbering of the conference units:

- ▶ Click the "Stop Resort" button.
The changes made are retained.

To change the numbering of individual conference units:

- ▶ Select a conference unit icon.
The selected icon is marked with a blue rectangle and the "Microphone Unit" box appears.
- ▶ Enter the desired number into the "ID" field.
The number of the conference unit icon is changed and the numbering of the other conference unit icons is automatically adjusted.

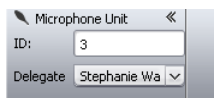

Assigning participant names to the conference units

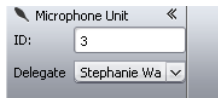

- ▶ Create a participant list (see page 185).
- ▶ Select a conference unit icon. The selected icon is marked with a blue rectangle and the "Microphone Unit" box appears.
- ▶ Select the desired name from the "Delegate" drop-down list. The name is assigned to the conference unit and is displayed below the icon. The conference unit assigned to the name appears in the "ID" column of the Delegate View window.

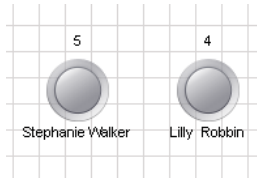

ID	First Name	Last Name	Chairperson
28	Stacey	Gowans	
27	Toni	McRollins	
26	Simon	Scott	
25	John	Conner	
24	Lilly	Robbin	
23	Stephanie	Walker	

Or:

- ▶ Select a participant from the participant list:
- ▶ Click the "Edit..." button. The "Delegate" window appears.
- ▶ Enter the number of the conference unit into the "Microphone ID" field. Depending on the number of the conference unit, the type of conference unit ("Delegate" or "Chairperson") is displayed behind "Unit Type" after saving.
- ▶ Click "OK". The window is closed and the number of the conference unit is assigned to the delegate entry (see above).

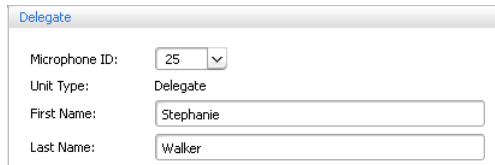

Changing the orientation/visibility of the icon labeling

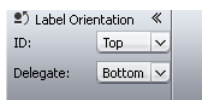

You can change the orientation/visibility of numbers and participant names assigned to the conference unit icons:

- ▶ Select a conference unit icon.
The selected icon is marked with a blue rectangle and the "Label Orientation" box appears.

To change the orientation/visibility of the number:

- ▶ Select the desired orientation from the "ID" drop-down list.
The number is displayed at the selected side of the icon or is hidden.

To change the orientation/visibility of the participant name:

- ▶ Select the desired orientation/visibility from the "Delegate" drop-down list.
The participant name is displayed at the selected side of the icon or is hidden.

Orientation/visibility
"Left"
"Top"
"Right"
"Bottom"
"Hidden"

Changing the font type

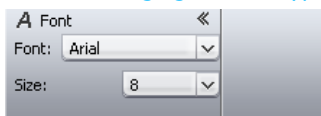

- ▶ Select the desired conference unit icon on the canvas.
The conference unit icon appears with a blue line around it. The "Font" box appears.
- ▶ Select the desired font from the "Font" drop-down list.
The font of the conference unit icon is changed.

i If a configuration file uses a font not installed on the central unit, this font is automatically replaced with the "Microsoft Sans Serif" font.

Changing the font size



- ▶ Select the desired conference unit icon on the canvas.
The conference unit icon appears with a blue line around it. The "Font" box appears.
- ▶ Select the desired font from the "Size" drop-down list.
The font size of the conference unit icon is changed.

Changing the font color

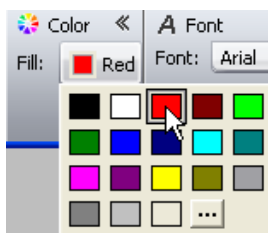

- ▶ Select the desired conference unit icon on the canvas.
The conference unit icon appears with a blue line around it. The "Color" box appears.
- ▶ Click the "Fill" button.
The list of colors appears.
- ▶ Select a default color.
Or:
- ▶ Select an individual color (see page 177).
The font color is assigned to the conference unit icon.

Adjusting the conference settings – "Setup" operating mode

Setting the conference modes

- ▶ Click the  icon on the toolbar. The "Conference Settings" window appears.

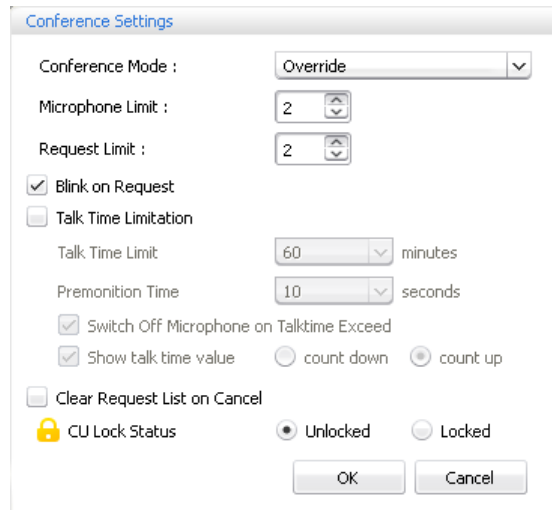

Setting the conference mode

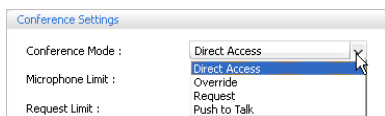

- ▶ Select the desired conference mode from the "Conference Mode" drop-down list.

Possible settings: "Direct Access" [factory default], "Override", "Push to Talk" and "Request"

- "Direct Access" mode and "Override" mode:

These two conference modes do not require the use of a chairperson unit.

If the maximum number of speakers who can take the floor simultaneously ("Microphone Limit") has not been reached, a further speaker can take the floor immediately.

Situation	The maximum number of speakers who can take the floor simultaneously ("Microphone Limit") has been reached.
Event	A further speaker presses the microphone key on his or her conference unit.
Behavior	<p>In "Direct Access" mode: The speaker has to wait until one of the current speakers passes on or loses his or her speaking privileges. He or she is then automatically granted speaking privileges.</p> <p>In "Override" mode: The speaker can take the floor immediately. The speaker with the longest speaking time loses his or her speaking privileges.</p>

- "Push to Talk" mode:

This conference mode does not require the use of a chairperson unit.

If the maximum number of speakers who can take the floor simultaneously ("Microphone Limit") has not been reached, any speaker can take the floor immediately as soon as he or she presses and holds the microphone key. Releasing the microphone key will discontinue the speaking privileges.

Situation	The maximum number of speakers who can take the floor simultaneously ("Microphone Limit") has been reached.
Event	A further speaker presses and holds the microphone key on his or her conference unit.
Behavior	Pressing and holding the microphone key causes no reaction. The speaker can only take the floor if the maximum number of speakers who can take the floor simultaneously drops below the specified limit value.

- "Request" mode:
For this mode to function, a chairperson unit is required or the conference system must be controlled via the "Conference Manager" software.
In "Request" mode, the chairperson receives requests to speak and grants speaking privileges according to the FIFO principle (First In – First Out), i.e. the speaker with the longest waiting time is granted speaking privileges.

Situation	The maximum number of requests to speak has been reached ("Request Limit").
Event	A further speaker makes a request to speak.
Behavior	The speaker can only make a request to speak if the maximum number of requests to speak drops below the specified limit value.

Setting the max. number of speakers who can take the floor simultaneously

The "Microphone Limit" menu item allows you to set the max. number of speakers who can take the floor simultaneously for all conference modes.

Please note that any connected chairperson unit (ADN C1 or ADN-W C1) is counted against the microphone limit (the number of chairperson units is limited to 10 max., see page 28). If you set a higher value (adjustment range "1" ... "10") than the one determined by the number of connected chairperson units, the system will reduce the microphone limit to the maximum possible value (see examples in the table).

Chairperson units	Possible "Microphone Limit" values	Possible number of active delegate units
0	"1" - "10"	1-10
4	"1" - "6"	1-6
10	"0"	0; the delegate units can only reproduce contributions made via the chairperson units.

For information on how this setting affects your conference, refer to the previous section "Adjusting the conference mode".

Adjustment range: "1" ... "10"

Microphone Limit :

- ▶ Enter the max. number of speakers who can take the floor simultaneously into the "Microphone Limit" field.

Setting the maximum number of requests to speak

The setting adjusted in the "Request Limit" field becomes effective only if you are using a chairperson unit ("Request" mode) or if you have selected "Direct Access" mode.

For information on how this setting affects your conference, refer to the section "Adjusting the conference mode" (see page 195).

Adjustment range: "0" ... "10"

Request Limit :

- ▶ Enter the max. number of requests to speak into the "Request Limit" field.

Activating/deactivating the flashing of the signal light ring ② when a request to speak is made

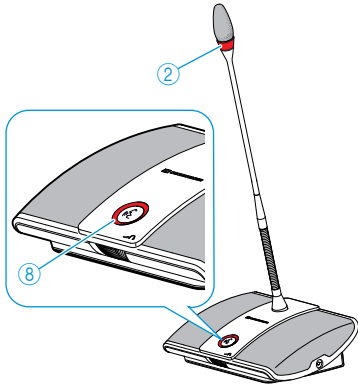

▶ Tick/untick the "Blink on Request" check box.

Check box	Behavior when a request to speak is made
is ticked <input checked="" type="checkbox"/> Blink on Request	When a participant makes a request to speak, the microphone LED ⑧ flashes green and the signal light ring ② flashes red.
is unticked <input type="checkbox"/> Blink on Request	When a participant makes a request to speak, the microphone LED ⑧ flashes green.

Activating/deactivating the speaking time limit

Talk Time Limitation

The "Talk Time Limitation" check box allows you to activate/deactivate the speaking time limit. The duration of the speaking time limit, the advance warning time, and the activation of an optical warning signal can be set individually.

i If you make a new request to speak, the speaking time countdown is started again.

▶ Tick/untick the "Talk Time Limitation" check box.

Check box	Behavior
is ticked <input checked="" type="checkbox"/> Talk Time Limitation	The speaking time is limited to the time period set.
is unticked <input type="checkbox"/> Talk Time Limitation	The speaking time is not limited.

Talk Time Limitation

Talk Time Limit: minutes

Premonition Time: seconds

To set the speaking time limit:

▶ Enter the speaking time into the "Talk Time Limit" field.

Adjustment range: "1" ... "60", adjustable in steps of 1 minute

To set the advance warning time:

▶ Select the desired advance warning time from the "Premonition Time" drop-down list.

Adjustment range: "0" ... "120", adjustable in steps of 10 seconds

This setting affects your conference as follows (example):

"Talk Time Limit" (speaking time limit)	15 minutes
"Premonition Time Limit" (advance warning time)	60 seconds
Effect	60 seconds before the speaking time limit expires, i.e. after 14 minutes in this example, the signal light ring ② and the microphone LED ⑧ start flashing red.

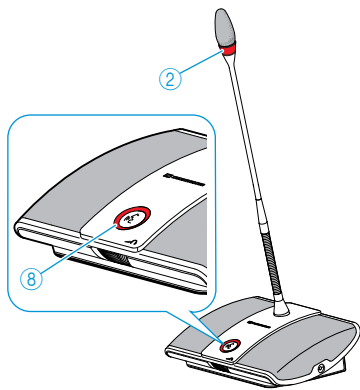

Setting the display of the individual speaking time

To determine the behavior when the individual speaking time is exceeded:

- ▶ Tick/untick the "Switch off Microphone on Talktime Exceed" check box.

Check box	Behavior of the conference unit when the individual speaking time is exceeded
is ticked <input checked="" type="checkbox"/> Switch Off Microphone or	The individual speaking time is terminated. The signal light ring ② and the microphone LED ⑧ go off.
is unticked <input type="checkbox"/> Switch Off Microphone or	The individual speaking time is continued. The signal light ring ② and the microphone LED ⑧ flash red until the speaker has finished speaking.

The "Show talk time value" check box allows you to activate/deactivate the display of the individual speaking time in the bar graphs shown in "Live" operating mode (see page 208).

- ▶ Tick/untick the "Show talk time value" check box.

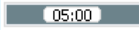
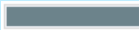
Check box	Display of the speaking time in the bar graphs
is ticked <input checked="" type="checkbox"/> Show talk time value	The individual speaking time is displayed in the bar graphs. 
is unticked <input type="checkbox"/> Show talk time value	The individual speaking time is not displayed in the bar graphs. 

When the display of the individual speaking time in the bar graphs is activated, the time can be counted downwards or upwards:

- ▶ Select the desired option button behind "Show talk time value".

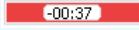
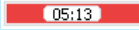
Option button	Way of counting
"count down" <input checked="" type="radio"/> count down	The individual speaking time is counted downwards. 
"count up" <input checked="" type="radio"/> count up	The individual speaking time is counted upwards. 

Setting the function of the "All Micros OFF" button

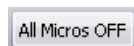

The "Clear Request List on Cancel" check box allows you to set the function of the "All Micros OFF" button (see page 212).

- ▶ Tick/untick the "Clear Request List on Cancel" check box in the "Conference Settings" window.

Check box	Function of the "All Micros OFF" button
is ticked <input checked="" type="checkbox"/> Clear Request List on Ca	Deactivates all delegate units and clears a request-to-speak list (if available).
is unticked <input type="checkbox"/> Clear Request List on Ca	Deactivates all currently active delegate units. All requests to speak are retained.

- ▶ Click "OK".
Your settings are saved and the "Conference Settings" window closes.

Locking/unlocking the central unit's operating menu



To protect the central unit's operating menu against any accidental change of settings:

- ▶ In the "Conference Settings" window, select the "Locked" option button behind "CU Lock Status".
- ▶ Click "OK".
The central unit's operating menu is locked and the "Conference Settings" window closes. To adjust settings via the operating menu, you have to deactivate the lock mode (see page 83).

To deactivate the lock mode:

- ▶ Select the "Unlocked" option button behind "CU Lock Status".
- ▶ Click "OK".
The central unit's operating menu is unlocked and the "Conference Settings" window closes.

Adjusting the audio settings

- ▶ Click the  icon on the toolbar.
The "Audio Settings" window appears.

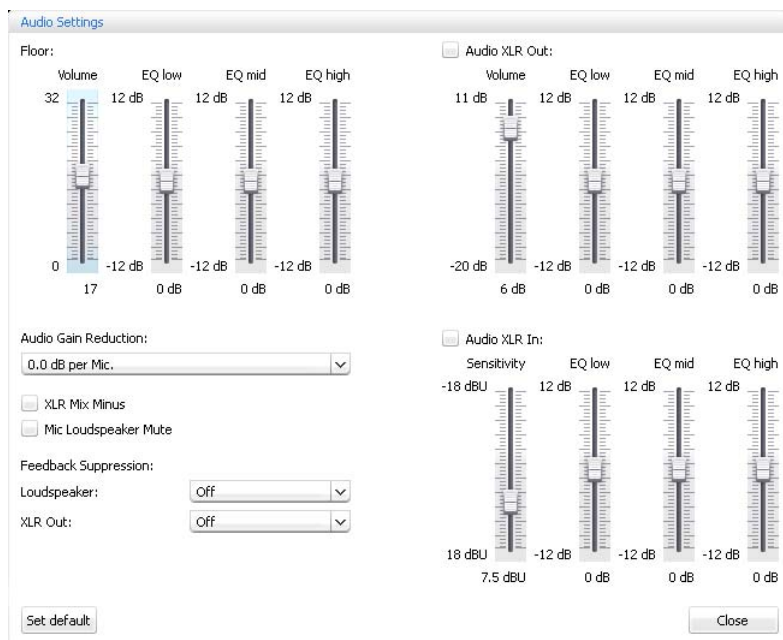

Setting the volume and the tone color of the floor channel



CAUTION

Danger of hearing damage due to loud hissing!

When the floor channel volume is set to a high level or when several participants speak simultaneously, feedback (loud hissing noise) can occur. This can cause hearing damage.

- ▶ Reduce the floor channel volume (see page 200 or page 214).
- ▶ Activate the "Feedback Suppression" function to be able to increase the volume before feedback can occur (see page 99 or page 202).
- ▶ Make sure that the "Audio Gain Reduction" function is activated (see page 201).
This function reduces the gain per active microphone by the selected level and thus prevents feedback.
- ▶ Increase the distance between the individual conference units to at least 50 cm.

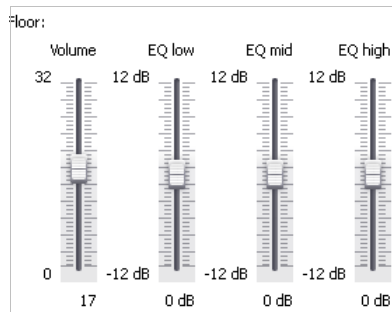

To set the floor channel volume:

- ▶ In the "Floor" area, move the "Volume" slider
 - upwards to increase the floor channel volume or
 - downwards to reduce the floor channel volume.
 The floor channel volume is changed immediately. The numeric value set is displayed below the slider.

To set the tone color of the floor channel:

- ▶ In the "Floor" area, move the "EQ low", "EQ mid" or "EQ high" sliders to change the tone color.
- ▶ Click "OK".
Your settings are saved and the "Audio Settings" window closes.

Adjusting the processing of the conference units' audio signals in the floor channel



The sum of the audio signals of all conference units is fed to the floor channel which in turn is output via the conference units' built-in loudspeakers and via the OUT audio output. The volume level of the floor channel increases with each additional audio signal* tends to overmodulate. The "Audio Gain Reduction" menu item allows you to adjust how the volume levels of the signals of the conference units are processed.

Situation	The audio signal of the 1. conference unit is fed to the floor channel.
Event	The audio signal of another conference unit is fed to the floor channel. The volume level of the floor channel would increase if the signal wasn't influenced.
Behavior	<p>"0.0 dB per Mic" ... "-3.0 dB per Mic" setting: With each additional audio signal, the volume level of the floor channel is reduced by the adjusted value.</p> <ul style="list-style-type: none"> ▶ Try out the different settings by activating the maximum number of open channels (see page 116). The floor channel should be heard at the desired volume level without any distortion or feedback. ▶ First start with low values. <p>"Linear Division" setting: The volume level of the floor channel is automatically reduced depending on the number of conference units with speaking privileges (see the following table).</p>

Conference units with speaking privileges	1	2	3	4	5	6	7	8	9	10
Reduction of the volume level of the floor channel in dB	0	-6	-9	-12	-14	-16	-17	-18	-19	-20

Activating/deactivating the filtering of the IN audio input from the OUT audio output

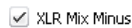

The "XLR Mix Minus" function filters the audio signals of the IN audio input from the audio signals of the OUT audio output. This prevents that external conference participants, which are for example connected via a video- or teleconference, hear delayed or double audio signals.

A connected video- or teleconferencing system must also support this function.

- ▶ Tick/untick the "XLR Mix Minus" check box.
 The audio signals of the IN audio input are filtered so that no double audio signals can be heard (check box is ticked) or the audio signals are not filtered (check box is unticked).

Deactivates the conference units' built-in loudspeakers for contributions coming from the conference units' microphones



The "Mic Loudspeaker Mute" function allows you to deactivate the conference units' built-in loudspeakers and headphones sockets for contributions coming from the conference units' microphones. Contributions are only output via the OUT output socket.

The conference units' built-in loudspeakers only output audio signals that are fed in via the IN audio input (e.g. from a video- or teleconferencing system).

- ▶ Tick/untick the "Mic Loudspeaker Mute" check box.
 Contributions coming from the conference units' microphones are not reproduced via the conference units' built-in loudspeakers (check box is ticked) or all audio signal are reproduced (check box is unticked).

* conference units and IN audio input

Activating/deactivating the function for eliminating feedback and for increasing the volume

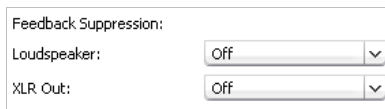

Via the “Feedback Suppression” submenu, you can change the volume adjustment of the floor channel (“Floor/Loudspeakers”) or the OUT audio output (“XLR Out”). You can increase the maximum possible volume in two steps while the risk of feedback due to the increased volume is reduced.

To adjust the “Feedback Suppression” function for the floor channel (“Floor/Loudspeakers”) or the OUT audio output (“XLR Out”):

- ▶ Select the desired setting from the “Loudspeaker” or “XLR Out” drop-down list. Possible settings: “Off”, “Low Intensity” and “High Intensity”
 - “Off”: The function is deactivated.
 - “Low Intensity”: The volume can be slightly increased (approx. +2 to +3 dB); feedback is reduced.
 - “High Intensity”: The volume can be strongly increased (approx. +5 to +6 dB); feedback is reduced.

Using the OUT audio output/IN audio input and setting the tone color

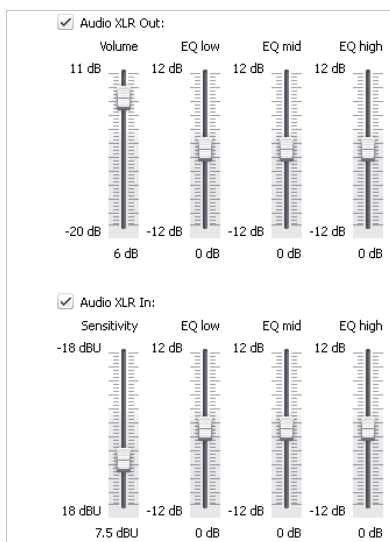

To activate/deactivate the OUT audio output/IN audio input:

- ▶ Tick/untick the “Audio XLR out”/ “Audio XLR In” check box.

The OUT audio output/IN audio input is activated (check box is ticked) or deactivated (check box is unticked).

To set the volume of the OUT audio output/the sensitivity of the IN audio input:

- ▶ In the “Audio XLR Out”/“Audio XLR In” area, move the “Volume” / “Sensitivity” slider
 - upwards to increase the volume/sensitivity or
 - downwards to reduce the volume/sensitivity.

The volume/sensitivity is changed immediately. The numeric value set is displayed below the slider.

- ▶ Set the sensitivity of the IN audio input so that the audio signal is not overmodulated at maximum input volume (see page 97).

To set the tone color of the OUT audio output/IN audio input:

- ▶ In the “Audio XLR Out”/“Audio XLR In” area, move the “EQ low”, “EQ mid” or “EQ high” sliders to change the tone color.

- ▶ Click “OK”.

Your settings are saved and the “Audio Settings” window closes.

Resetting the audio settings



To reset the audio settings for the floor channel and for the IN audio input and the OUT audio output to the factory default settings:

- ▶ Click the “Set default” button. All sliders are reset.

Controlling and monitoring a conference – "Live" operating mode

In "Live" operating mode, you can:

- control a conference from the screen,
- use either the Room View window or the Delegate View window for controlling the conference,
- use the graphical/photographical representations of the conference room that you created in "Setup" operating mode,
- – with a mouse click – grant or withdraw speaking privileges to/from individual conference units,
- monitor speaking privileges
- adjust the radio settings and monitor the RF signal quality and the battery status of the wireless conference units
- start and control an audio recording on a USB mass storage device



If you change the conference settings in "Live" operating mode, these settings are saved in the current configuration.

Settings that customize the view of your configuration and settings that affect the user interface of the "Conference Manager" are not saved.

Switching to "Live" operating mode – starting/ending a conference

Preparing and starting a conference

- ▶ Load a conference configuration (see page 156).

Or:

- ▶ Prepare a conference in "Setup" operating mode (see page 172).

The "Save Conference" window appears, allowing you to save the configuration on the central unit.

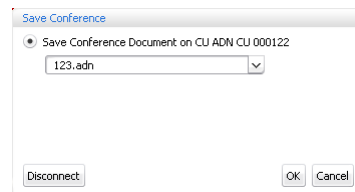

It is vital to observe the information provided in the chapter "Saving a configuration" on page 157.

- ▶ Enter a file name into the drop-down list.
- ▶ Click "OK".

The configuration is saved on the central unit and "Live" operating mode is started. The View windows change their appearance accordingly and the "Live" button is highlighted in red.

To open the Room View window in “Live” operating mode:

- ▶ Click the Room View button . The Room View window appears:

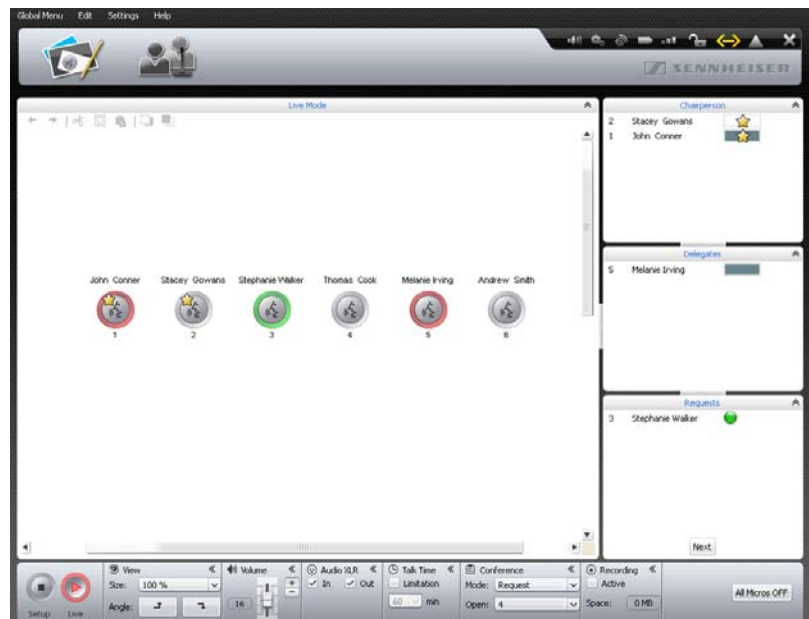

To open the Delegate View window in “Live” operating mode:

- ▶ Click the Delegate View button . The Delegate View window appears:

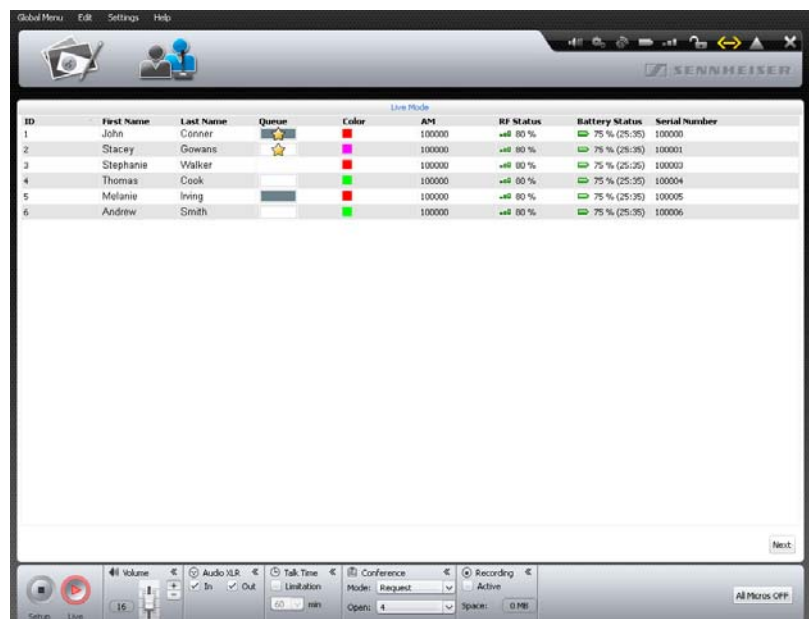

Using the software for controlling a running conference

If you want to use the software for controlling a running conference:

- ▶ Load the configuration of the running conference (see page 156). The software switches to “Live” operating mode. All active conference units remain active and all requests to speak are retained.

 If you have activated automatic loading of a configuration, the configuration is automatically loaded in “Live” operating mode (see page 157).

Monitoring a conference

You can monitor a conference from the screen without intervening.

Monitoring a conference using the Room View window

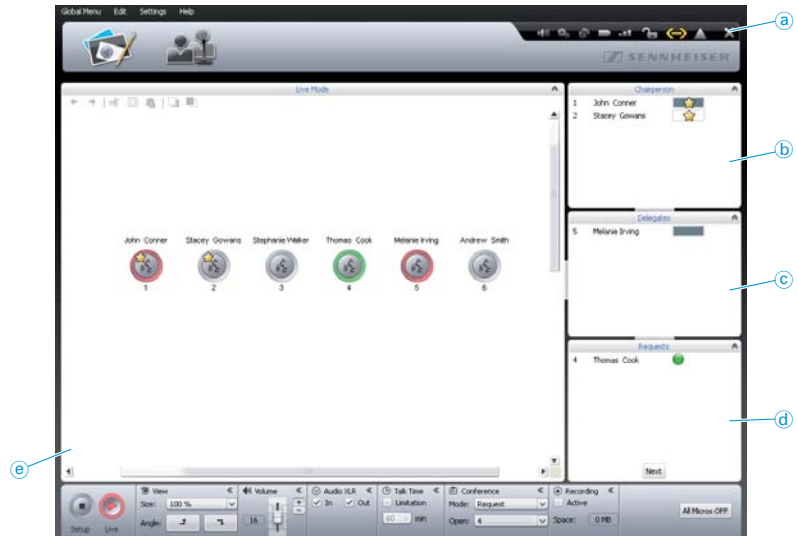

Element	Function/Meaning
(a)	Toolbar for status and warning icons of the conference system and the wireless conference units (see page 206)
(b)	Permanent list of chairperson units, sorted by "ID" number (see page 208)
(c)	Delegate units with speaking privileges, sorted by chronological order of registration (see page 208)
(d)	Delegate units that have made a request to speak, sorted by chronological order of registration (see page 208)
(e)	Canvas with initialized conference unit icons (see page 207)



Conference unit icons are not displayed in "Live" operating mode if

- the conference units icons have not been initialized (see page 189) or
- a conference unit icon has been assigned to a participant who is not to be displayed in "Live" operating mode (the "Show in Live Mode" check box is unticked, see page 184).

Monitoring a conference using the Delegate View window



Element	Function/Meaning
e	<p>Permanent list of conference units, sorted by "ID" number, the first name ("First Name"), the last name ("Last Name"), the speaking privileges status ("Queue"), the color assigned ("Color"), the serial number of the antenna module ("AM"), the RF signal quality ("RF Status") and the battery status ("Battery Status") or the serial number ("Serial Number").</p> <p>Settings made in "Setup" operating mode regarding the participant list (see page 184) are also taken into account in "Live" operating mode.</p> <p>The different bar graphs indicate the speaking privileges status of the conference units (see page 208)</p>
f	<p>Permanent list of uninitialized conference units Designation "Undefined Name (S/N #####)"</p>

i Conference unit icons are not displayed in "Live" operating mode if a conference unit icon has been assigned to a participant who is not to be displayed in "Live" operating mode (the "Show in Live Mode" check box is unticked, see page 184).

Displaying the status and warning messages of the conference system

To display the status and warning messages of the overall conference system:









- ▶ Click the icon on the toolbar.
The "Event Log" window appears (see page 219).

i In case of critical warnings or errors, the icon changes to .

i If the RF signal quality or battery status of a wireless conference unit show critical values, the following icons are displayed: (see page 208).

Overview of the conference unit icons

In the Room View window, the conference unit icons display the current status of the conference units connected to the central unit. The icons of chairperson units are marked with a star ☆.

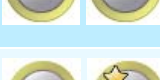

Icon	Function/Meaning
	Conference unit icon is not assigned to a conference unit ▶ Initialize the conference unit (see page 191).
	Conference unit is ready for operation
	Conference unit with speaking privileges
 flashing	Conference unit with speaking privileges, shortly before the speaking time limit expires or when the speaking time limit is exceeded
 flashing	Conference unit with speaking privileges but muted (via the priority function of the chairperson unit, see page 119)
 flashing	Conference unit has made a request to speak
	Conference unit icon is assigned to a conference unit but the conference unit is not available ▶ Check the conference unit (see page 210).
	Type of conference unit assigned to the conference unit icon does not correspond to the connected hardware ▶ Check the conference unit (see page 210).
	Battery charge of the wireless conference unit is low (battery charge <10%; see page 208)
	RF signal quality of the wireless conference unit is critical, transmission can be subject to interference (RF signal quality <20%; see page 208)

To call up detailed information on the individual conference units (e.g. serial number or – in the case of wireless conference units – remaining battery capacity or RF signal quality):

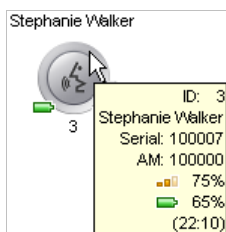
- ▶ Hover the mouse over the conference unit icon.
After approx. 2 seconds, the following information appears:









Detail	Meaning	Conference units
ID: 3	Numbering of the conference unit	Wired and wireless conference units
Stephanie Walker	Name of the conference participant assigned to the conference unit (where applies)	
Serial: 100001	Serial number of the conference unit	

Detail	Meaning	Conference units
AM: 100000	Serial number of the antenna module to which the wireless conference unit is connected	Wireless conference units only
 75%	RF signal quality (approximate value)	
 65%	Remaining battery capacity (approximate value)	
(22:10)	Remaining operating time in hours:minutes (approximate value)	

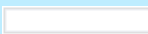
 To simultaneously view detailed information on all conference units, use the Delegate View window where information relating to the conference units is permanently listed and visible.

Overview of the bar graphs

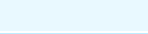
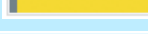
In the Room View window and in the Delegate View window, the bar graphs display the current speaking privileges status of the conference units.

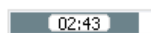

Bar graph	Meaning
	Chairperson unit is deactivated
	Delegate unit is deactivated
	Chairperson unit with speaking privileges
	Delegate unit with speaking privileges, 100% of the speaking time is available
	Delegate unit with speaking privileges, approx. 50% of the speaking time is available
	Delegate unit shortly before the speaking time limit expires
	Delegate unit when the speaking time limit is exceeded
	Conference unit with speaking privileges but muted (via the priority function of the chairperson unit, see page 119)
 flashing	Delegate unit has made a request to speak



If you activated the display of the individual speaking time (see page 198), the current speaking time is displayed in the center of the bar graph.



Monitoring wireless conference units

To show and hide the battery status and the RF signal quality of the wireless conference units:

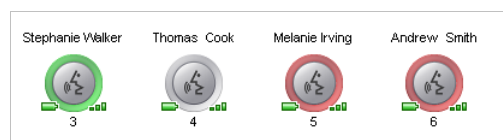
- ▶ Click the  icon or the  icon on the toolbar. In the Room View window, the conference unit icons of the wireless conference units show or hide the current battery status and the current RF signal quality.







If the battery charge of a wireless conference unit is low, the  icon on the toolbar changes to  and the corresponding conference unit icon in the Room View window displays the current battery status (see diagram on the left).

- ▶ Check if the remaining battery charge is sufficient. **Attention:** The displayed remaining operating time is an approximate value!
- ▶ If necessary, recharge the battery pack (see page 51) or replace it with a charged one.







If the RF signal quality of a wireless conference unit is critical, the  icon on the toolbar changes to  and the corresponding conference unit icon in the Room View window displays the poor RF signal quality (see diagram on the left).

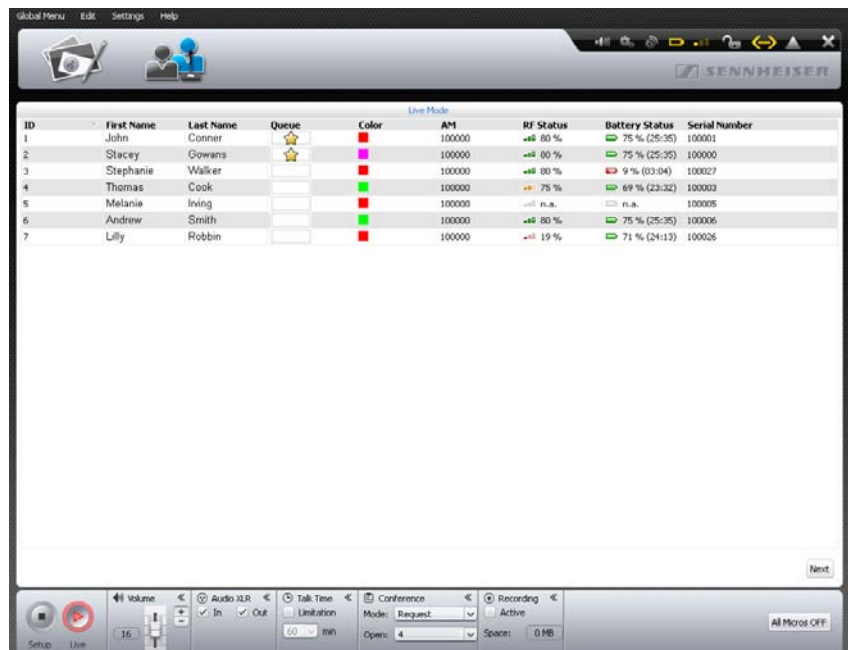



- ▶ Adjust the settings of the wireless conference unit and reduce its distance to the antenna module in order to reduce RF interference (see page 82).

The Delegate View window permanently displays detailed information on all wireless conference units:



The “RF Status” and “Battery Status” icons change color depending on the current operating status:

“RF Status” icon (RF signal quality)	Meaning
 green	The RF signal is of good quality, RF transmission is interference-free (RF signal quality is approx. 80–100%)
 yellow	The RF signal is of sufficient quality, RF transmission can be subject to minimal interference (RF signal quality is approx. 20–80%)
 red	The RF signal is of bad quality, interference and dropouts occur (RF signal quality is <20%)
 gray	No information provided on the RF signal quality (e.g. in “Setup” operating mode without active connection to the central unit)

"Battery Status" icon	Meaning
 green	The battery pack is sufficiently charged, operating time is approx. 12-20 hrs (battery charge is approx. 60-100%)
 yellow	The battery pack runs short, operating time is less than 12 hrs (battery charge is approx. 10-60%)
 red	The battery pack is almost flat, recharge or replace the battery pack (battery charge is <10%)
 gray	No information provided on the battery status (e.g. in "Setup" operating mode without active connection to the central unit)

 In "Live" operating mode, you can show and hide the columns in the participant list as you like (see page 150).

Conference unit of a conference unit icon not available or wrongly assigned



If an initialized conference unit icon cannot find the assigned conference unit (e.g. due to loose cabling or a flat battery pack), the conference unit icon is marked with a yellow circle. You cannot use the conference unit in question.

To be able to use the conference unit in question again:

- ▶ With a wired conference unit, check the cabling and the conference unit, check if the cabling is wrong or if another error has occurred (see page 56).

Or, with wireless conference units:

- ▶ Check the battery charge status (see page 51) and check if the battery pack is correctly inserted (see page 47).
- ▶ Check the RF signal quality (see page 82) and check if the RF transmission range is exceeded.

To use a new conference unit and to newly assign the conference unit icons:

- ▶ Re-initialize the conference units (see page 189).



If the type of wired conference unit (ADN C1 chairperson unit or ADN D1 delegate unit) assigned to the conference unit icon does not correspond to the connected hardware, the conference unit icon is marked with a yellow circle and an exclamation mark. You can use the conference unit in question.

To re-establish the correct assignment of the conference unit type:

- ▶ Replace the conference unit so that it corresponds to the type of the conference unit icon assigned.

Or:

- ▶ Re-initialize the conference units (see page 189).

 The ADN-W C1 and ADN-W D1 wireless conference units are clearly assigned to the conference unit icons by means of their serial numbers so that the conference unit icons cannot be accidentally confused.

Granting/withdrawing speaking privileges using the Room View window

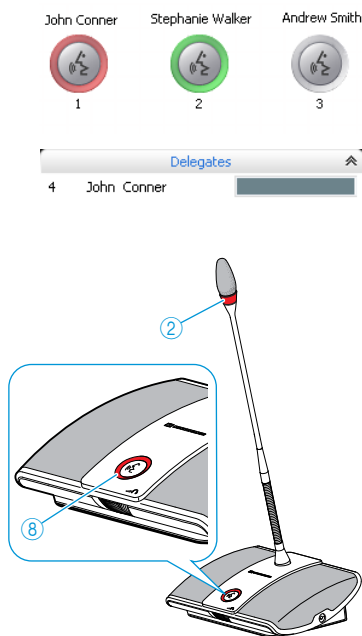

Controlling a conference

To grant speaking privileges to a conference unit (in all conference modes):

- ▶ Click a conference unit icon. The conference unit icon is then marked with a red circle and the conference unit is displayed in the "Delegates" box. The bar graph displays the current speaking privileges status. The conference unit is granted speaking privileges and the signal light ring ② and the microphone LED ⑧ light up red.

To withdraw speaking privileges from a conference unit:

- ▶ Click a conference unit icon marked with a red circle. The conference unit icon turns gray and the conference unit is removed from the "Delegates" box. The conference unit loses its speaking privileges and the signal light ring ② and the microphone LED ⑧ go off.

To arbitrarily grant speaking privileges to a conference unit that has made a request to speak (in "Request" and "Direct Access" mode):

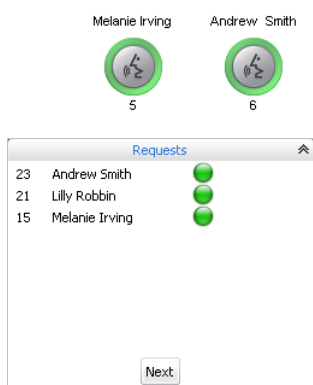

- ▶ Click a green flashing conference unit icon.

Or:

- ▶ In the "Requests" box, click the conference unit to which you want to grant speaking privileges. The conference unit is granted speaking privileges (see above) and is removed from the "Requests" box.

To grant speaking privileges to a conference unit by the order of the request-to-speak list (in "Request" and "Direct Access" mode):

- ▶ Click the "Next" button. The conference unit is granted speaking privileges (see above) and is removed from the "Requests" box.



Granting/withdrawing speaking privileges using the Delegate View window

ID	First Name	Last Name	Queue
2	Jessica	McGowan	<input type="checkbox"/> ★
3	Stephanie	Walker	<input type="checkbox"/> ★
4	Thomas	Cook	<input type="checkbox"/>
6	Andrew	Smith	<input checked="" type="checkbox"/>
1	John	Conner	<input type="checkbox"/>

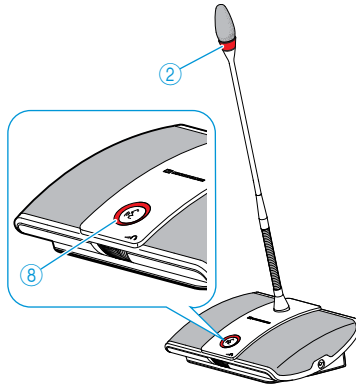

To grant speaking privileges to a conference unit:

- ▶ Click the name of the delegate to whom you want to grant speaking privileges.

The bar graph displays the current speaking privileges status. The conference unit is granted speaking privileges and the signal light ring ② and the microphone LED ⑧ light up red.

To withdraw speaking privileges from a conference unit:

- ▶ Click the name of the delegate whose speaking privileges you want to withdraw.

The bar graph displays that the conference unit is deactivated. The conference unit loses its speaking privileges and signal light ring ② and the microphone LED ⑧ go off.

ID	First Name	Last Name	Queue
2	Jessica	McGowan	<input checked="" type="checkbox"/> ★
3	Stephanie	Walker	<input type="checkbox"/> ★
6	Andrew	Smith	<input checked="" type="checkbox"/>
4	Thomas	Cook	<input checked="" type="checkbox"/>

To arbitrarily grant speaking privileges to a conference unit that has made a request to speak (in "Request" and "Direct Access" mode):

- ▶ Click the name of the delegate to whom you want to grant speaking privileges. The conference unit is granted speaking privileges.

To grant speaking privileges to a conference unit that has made a request to speak in the order of the request-to-speak list (in "Request" and "Direct Access" mode):

- ▶ Click the "Next" button. The conference unit is granted speaking privileges.



Deactivating all conference units



- ▶ Click the "All Micros OFF" button.

The conference system behaves as set (see page 198):

- All LEDs go off and the delegate units are deactivated. A request-to-speak list, if available, is cleared.
- All currently active delegate units are deactivated. All requests to speak are retained.

Adding conference units to the conference system during operation

You can also add conference units to the conference system during operation (see page 121).

All added delegate units are ready for immediate use. If you add chairperson units, you have to re-initialize them. Note that this will interrupt the conference (see page 94 or page 191).

ID	First Name	Last Name	Queue
-		Undefined Name (S/N 100028)	<input type="text"/>
-		Undefined Name (S/N 100029)	<input type="text"/>
-		Undefined Name (S/N 100030)	<input type="text"/>
-		Undefined Name (S/N 100002)	<input type="text"/> 

If you are using the "Conference Manager" software, newly added conference units only appear in the Delegate View window with the label "Undefined Name (S/N #####)" and the serial number. The newly added wired or wireless conference units are sorted by device type and serial number.

Via the Delegate View window of the "Conference Manager" software, you can also control conference units that are not initialized (see page 212).



When adding wired conference units to the conference system, observe the maximum number of conference units per cable string in order to ensure operational reliability (see page 29).

Adjusting settings during a running conference

In "Live" operating mode, the boxes "View", "Volume", "Audio XLR", "Talk Time", "Conference" and "Recording" are shown in the lower part of the window.

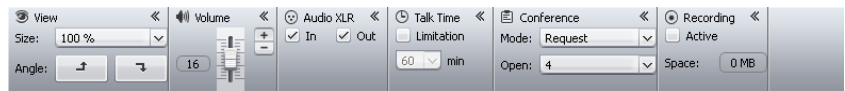

i If you change the conference settings in Live operating mode, these settings are saved in the current configuration.

Settings that customize the view of your configuration and settings that affect the user interface of the "Conference Manager" are not saved.

Changing the view of the canvas

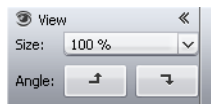

To enlarge/reduce the size of the canvas:

- ▶ In the "View" box, select the desired scaling factor from the "Size" drop-down list.
The size of the canvas is adjusted.

To rotate the contents of the canvas:

- ▶ Click **↕** or **↻**.
The contents of the canvas are rotated by 90°.

i Settings that customize the view of your configuration and settings that affect the user interface of the "Conference Manager" are not saved.

Setting the volume of the conference units' built-in loudspeakers



CAUTION

Danger of hearing damage due to loud hissing!

When the floor channel volume is set to a high level or when several participants speak simultaneously, feedback (loud hissing noise) can occur. This can cause hearing damage.

- ▶ Reduce the floor channel volume (see page 200 or page 214).
- ▶ Activate the "Feedback Suppression" function to be able to increase the volume before feedback can occur (see page 99 or page 202).
- ▶ Make sure that the "Audio Gain Reduction" function is activated (see page 201).
This function reduces the gain per active microphone by the selected level and thus prevents feedback.
- ▶ Increase the distance between the individual conference units to at least 50 cm.



- ▶ In the "Volume" box, move the slider 
 - upwards to increase the floor channel volume or
 - downwards to reduce the floor channel volume.
The value next to the slider changes ("0"-"32") and the floor channel volume is adjusted.

Adjustment increments for the floor channel volume that can be adjusted via the central unit:

Value shown on the standard display	Adjustment increments for the floor channel volume
0	0
1 to 8	2.5 dB
9 to 16	2.0 dB
17 to 24	1.5 dB
25 to 32	1.0 dB

Activating/deactivating the audio input/output

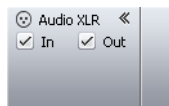

To activate or deactivate the **IN** audio input or the **OUT** audio output:

- ▶ Tick/untick the check boxes in the "Audio XLR" box:

Audio input/output	activated	deactivated
In audio input	<input checked="" type="checkbox"/>	<input type="checkbox"/>
Out audio output	<input checked="" type="checkbox"/>	<input type="checkbox"/>

Activating/deactivating the speaking time limit

i If, in "Live" operating mode, you change settings that affect the conference mode (see next chapters), the conference will be interrupted. A confirmation prompt appears:

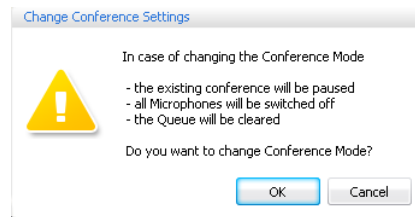

To activate or deactivate the speaking time limit:



- ▶ In the "Talk Time" box, tick/untick the "Limitation" check box (see also page 197):
 - ticked : The speaking time limit is activated.
 - unticked : The speaking time limit is deactivated.

To change the speaking time limit:

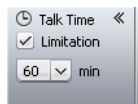

- ▶ In the "Talk Time" box, enter the desired speaking time limit into the drop-down list field (see also page 197).

Changing the conference mode

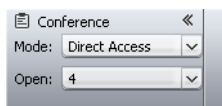

- ▶ From the "Mode" drop-down list in the "Conference" box, select the desired conference mode (see page 195).

Changing the maximum number of speakers who can take the floor simultaneously



- ▶ From the "Open" drop-down list in the "Conference" box, select the maximum number of speakers who can take the floor simultaneously (see also page 196).

Changing the maximum number of requests to speak

- ▶ Change the maximum number of requests to speak (see page 196).

Changing the behavior of the signal light ring ② when a request to speak is made

- ▶ Change the behavior of the signal light ring ② when a request to speak is made (see page 197).

Recording a conference



- ▶ In the “Recording” box, tick/untick the “Active” check box:
 - ticked : Recording is started.
 - unticked : Recording is stopped.

The “Space” text field provides information on the remaining memory space of the USB mass storage device.

 For information on the requirements and recording possibilities, refer to page 122.

Exiting “Live” operating mode

You can exit the “Live” operating mode by calling up the “Setup” operating mode:



- ▶ Click the “Setup” button.
The “Stop” warning message appears.

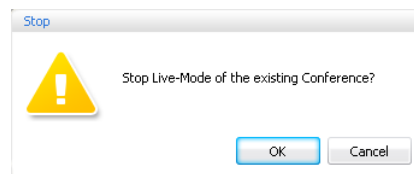

- ▶ Click “OK”.
The software switches to “Setup” operating mode and the View windows change their appearance accordingly. A running conference is **not** interrupted and can be continued. An audio recording on a USB mass storage device is not stopped.

Recording a conference – "Conference Recording"

In "Live" operating mode, the ADN CU1 central unit allows you to record the floor channel and the channels of all active conference units as audio files on a USB mass storage device. Information on the requirements and recording possibilities can be found in the chapter "Recording a conference" on page 122.

CAUTION

Loss of an audio recording!

If you disconnect the USB mass storage device from the central unit during an audio recording, the audio recording can be rendered unusable due to faulty data.

- ▶ Stop the audio recording (see page 218) and make sure that the  icon is no longer displayed in the CU1 display panel before disconnecting the USB mass storage device from the central unit.

Starting an audio recording

- ▶ Make sure that the USB mass storage device is correctly connected to the ADN CU1 central unit (see page 75).
- ▶ In the menu bar, click "Settings" > "Conference Recording". The "Conference Recording" window appears.



- ▶ Click "Record".

The recording is started. The "Record" button is grayed out and the "Stop" button and the recording icon are active. The  icon ²⁵ is displayed on the CU1 display panel.

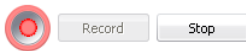

i If you exit the "Live" operating mode, the audio recording is not stopped.



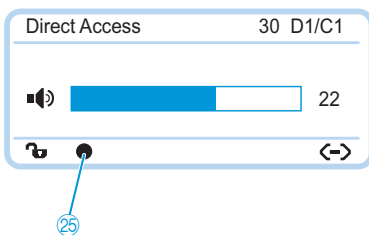

Monitoring an audio recording

The "Event Log" function of the "Conference Managers" software logs all information on the audio recording (see page 219).

In "Live" operating mode, the "Recording" box shows whether or not the conference is recorded and provides information on the available memory space on the USB mass storage device (see page 216).



The CU1 display panel displays the status of the audio recording:

 icon	Meaning
	Audio recording in progress
	Memory space < 500 MB Depending on the number of channels recorded, the memory capacity will suffice for approx. 15 minutes of recording. Stop the audio recording (see page 218) and, if necessary, change the USB mass storage device.
	After finishing the audio recording, data is still written to the mass storage device.
	An error occurred during recording. The recording was interrupted.
The central unit's display panel lights up red	

To view the available memory space:

- ▶ In the menu bar, click "Settings" > "Conference Recording". The "Conference Recording" window appears and the available memory space ("Available disk space") is displayed.



To close the "Conference Recording" window:

- ▶ Click "Close".

Stopping an audio recording

- ▶ In the menu bar, click "Settings" > "Conference Recording". The "Conference Recording" window appears.





- ▶ Click "Stop".



The recording is stopped. The "Stop" button and the recording icon are grayed out and the "Record" button is active. The CU1 display panel does not display the recording icon.

Using the log and diagnosis function – "Event Log"

The log and diagnosis function allows you to log all changes to the conference system. During normal operation, the  icon is displayed on the toolbar. As soon as a change to the system or an error is detected, the  icon on the toolbar changes to .

To start the "Event Log" function:

- ▶ Click the  or  icon on the toolbar.

Or, if the "Processing..." window is displayed:



- ▶ Click the  icon. The "Event Log" window appears.



Time	Location	Qualifier	Description
2012/12/07 11:22:39	CU Main 000122	Info	Conference Recording
2012/12/07 10:46:19	Power Supplies	Info	HW Version -
2012/12/07 10:46:19	D1w / C1w	Info	SW Version 1.0.0.0
2012/12/07 10:46:19	AM	Info	SW Version 1.0.0.0
2012/12/07 10:46:19	AM	Info	HW Version 1
2012/12/07 10:46:19	D1w / C1w	Info	HW Version 1
2012/12/07 10:46:19	CU Main 000122	Info	Topology update: Found connected conference units=29, Power Supplies=0
2012/12/07 10:46:19	D1 / C1	Info	SW Version --,--,---
2012/12/07 10:46:19	CLUSB	Info	SW Version 1.0.0.0
2012/12/07 10:46:19	CU Main 000122	Info	SW Version 0.0.0.0
2012/12/07 10:46:19	D1 / C1	Info	HW Version -

Changes and warnings are listed in chronological order:

Column	Meaning/Function
"Time"	Time of the ADN CU1 central unit
"Location"	Location of information/error (ADN CU1 central unit = "CU Main", ADN PS power supply = "PS", ADN C1 chairperson unit = "PU", ADN D1 delegate unit = "DU")
"Qualifier"	Message qualifier: <ul style="list-style-type: none"> • "Info" • "Warning" • "Error" • "Critical Error"
"Description"	Error description in English language A selection of possible error descriptions is given in the following chapter.
"Value"	Optional additional value (e.g. error code)

Selection of possible information in the "Event Log"

The "#" characters in the following tables represent varying numeric values (e.g. "Location" [CU Main #####] stands for an ADN CU1 central unit with the serial number e.g. "[CU Main 661235]").

"Info"

Column "Description"	"Location"	Meaning
Conference Recording	[CU Main #####]	Audio recording started
Conference Recording Off	[CU Main #####]	Audio recording stopped
HW Version #/ VARIOUS	[DU / PU] / [CUSB]	Hardware versions of the ADN D1 chairperson unit ("DU") or ADN C1 delegate unit ("PU") or the ADN CU1 central unit ("CUSB"); are different ("VARIOUS")
HW Version #/ VARIOUS	[Power Supplies]	Hardware version of the ADN PS power supply; is different ("VARIOUS")
SW Version #.#.#.#	[DU / PU] / [CUSB]	Software version of the ADN D1 chairperson unit ("DU") or ADN C1 delegate unit ("PU") or the ADN CU1 central unit ("CUSB")
SW Version #.#.#.#	[CU Main #####]	Software version of the ADN CU1 central unit ("CU Main")
SW Version VARIOUS	[DU / PU] / [CUSB]	Software versions of the ADN D1 chairperson unit ("DU") or ADN C1 delegate unit ("PU") or the ADN CU1 central unit ("CUSB") are different
Topology update: Found connected conference units=##, Power Supplies=##	[CU Main #####]	The set up of the conference system has been changed; conference units and/or power supplies have been added or removed

"Warning"

Column "Description"	"Location"	Meaning
Available USB device space below 500 MB	[CU Main #####]	Available memory space on the USB mass storage device < 500 MB
Bus Error (### Frames)	[CU Main #####]	Data transmission error; number of lost data frames
More than 400 conference units (x) connected!	[CU Main #####]	More than 400 conference units are connected. System stability is no longer guaranteed! A system error can occur.
Chairperson unit S/N: ##### at pos.### NOT INITIALIZED	[CU Main #####]	The chairperson unit is not initialized
More than 15 ADN PS devices (x) connected!	[CU Main #####]	The maximum number of connected ADN PS power supplies has been exceeded.
Conference Reinit due to inconsistent topology	[CU Main #####]	Re-initialization due to inconsistent set up of the conference system
Device Temperature Overheat/OK	[CU Main #####]/ [PS #####]	Temperature of the central unit/power supply is within the permissible range ("ok")/too high ("overheat")
Fan status: Fan1=ALERT/OK; Fan2=ALERT/OK	[CU Main #####]/ [PS #####]	Fan 1/2 of the central unit/power supply is in operation ("ok")/has failed ("ALERT")
High Current status: (Port1=ALERT/OK, Port2=ALERT/OK)	[CU Main #####]/ [PS #####]	Current at PORT I/PORT II of the central unit/power supply is within the permissible range ("ok")/too high ("ALERT")
Low Voltage Alert at Unit Pos.###	[Unit at Pos.###]	Voltage required for powering the conference units is too low
More than max number (150) of wireless conference units tried to register to the system	[CU Main #####]	The maximum number of wireless conference units has been exceeded.
Microphone Limit changed to ## due to number of chairperson units	[CU Main #####]	Microphone limit has been changed due to changed number of chairperson units
Microphone limit readjusted to max possible value=##	[CU Main #####]	Microphone limit has been adjusted to the maximum possible value.
More than 4 ADN-W AM devices (x) connected!	[CU Main #####]	The maximum number of antenna modules (4 per central unit) has been exceeded.
Premonition Time readjusted to ##s due to Talk Time Limit conflict	[CU Main #####]	Advance warning time has been adjusted due to conflicts with the speaking time limit
Short-Circuit status: (Port1=ALERT/OK, Port2=ALERT/OK)	[CU Main #####]/ [PS #####]	Short-circuit at PORT I/PORT II of the central unit/power supply ("ALERT")/no short-circuit at PORT I/PORT II of the central unit/power supply ("ok")

"Error"

Column "Description"	"Location"	Meaning
Cabling error on power supply unit at pos.### (Port##.##)	[CU Main #####]	Faulty system cable connected to power supply
Conference Unit S/N: ##### failure at Pos.###: Please contact service	[CU Main #####]	Defective conference unit has been detected. Contact your Sennheiser partner (see page 236)
Corrupted USB device	[CU Main #####]	Error of the USB mass storage device
CU recording performance problem	[CU Main #####]	Performance problem of the CU1. In case of repeated occurrence, contact your Sennheiser partner (see page 236).
Insufficient USB device performance	[CU Main #####]	Read/write speed of the USB mass storage device is not sufficient
Invalid USB device format	[CU Main #####]	USB mass storage device uses a file system that is not supported
No USB device available	[CU Main #####]	No USB mass storage device available
Selftest result: Error	[CU Main #####]	Self-test has failed
Set Conference mode=## denied => Value out of range {Automatic=##, Overrun=##, Request=##, Push_To_Talk=##}	[CU Main #####]	Conference mode could not be changed ("denied") because the value is out of the permissible range
Set Floor Mix=## denied => Value out of range(##..##)	[CU Main #####]	Automatic volume reduction could not be changed because the value is out of the permissible range
Set Floor Volume=## denied => Value out of range(##..##)	[CU Main #####]	Volume of the floor channel could not be changed ("denied") because the value is out of the permissible range
Set Microphone limit=## denied => Value out of range(##..##)	[CU Main #####]	Number of speakers who can take the floor simultaneously could not be changed ("denied") because the value is out of the permissible range
Set Operating Mode=## denied => Value out of range(##..##)	[CU Main #####]	Operating mode of the central unit (e.g. initialization mode or conference mode) could not be changed ("denied") because the value is out of the permissible range
Set Premonition Time=##s denied => Value out of range(0..##s)	[CU Main #####]	Advance warning time could not be changed ("denied") because the value is out of the permissible range
Set Request Limit=## denied => Value out of range(##..##)	[CU Main #####]	Maximum number of requests to speak could not be changed ("denied") because the value is out of the permissible range

Column "Description"	"Location"	Meaning
Set Speaker Feedback Suppression=## denied => Value out of range [##.##]	[CU Main #####]	Feedback suppression function could not be changed ("denied") because the value is out of the permissible range
Set Talk Time Limit=##min denied => Value out of range(##min..##min)	[CU Main #####]	Speaking time limit could not be changed ("denied") because the value is out of the permissible range
Set Talk Time=##s denied => Conflict with existing premonition time=##s	[CU Main #####]	Speaking time limit could not be changed due to conflicts with the advance warning time ("denied") because the value is out of the permissible range
Set XLR In Sensitivity=## denied => Value out of range(##.##)	[CU Main #####]	Sensitivity of the XLR IN input could not be changed ("denied") because the value is out of the permissible range
Set XLR Out Feedback Suppression=## denied => Value out of range [##.##]	[CU Main #####]	Function for eliminating feedback and for increasing the volume of the XLR OUT audio output could not be changed ("denied") because the value is out of the permissible range
Set XLR Out Volume=## denied => Value out of range(##.##)	[CU Main #####]	Volume of the XLR OUT audio output could not be changed ("denied") because the value is out of the permissible range
Unknown Conference Recording Status (##)	[CU Main #####]	Unknown status of the audio recording
USB device full	[CU Main #####]	Memory space on the USB mass storage device is full

"Critical Error"

Column "Description"	"Value"	"Location"	Meaning/solution	
Comm. Error - Read Manual FAQ	60002	[CU Main #####]	Faulty system cable or cabling error, see page 233	
D1/C1 at PS cascading port	60003	[CU Main #####]	Cabling error, see page 233	
PS unit at PS conference port	60004	[CU Main #####]		
Ring cabling between port I+II	60005	[CU Main #####]		
Ring cabling between two PS	60006	[CU Main #####]		
Ring cabling at CU1 ports	60007	[CU Main #####]		
Max number of devices exceeded	60008	[CU Main #####]		
Slave GUID duplicate	60009	[CU Main #####]		
AM at PS cascading port	60010	[CU Main #####]		
Cabling IN/OUT Error at blinking unit S/N: ##### at Pos.###	###	[CU Main #####]		Connection error of a conference unit (IN socket and OUT socket have been accidentally swapped); the microphone LED and the signal light ring of the conference unit flash red
Conference Mailbox command Object ## Error ##at Unit Pos.###	###	[CU Main #####]		Internal command error
Critical Error ## [##]	###	[CU Main #####]	Critical error	
Device Runtime Error [##]	###	[CU Main #####]	Run-time error	
Mailbox Command Timeout => Unit at Pos. ### INVALID	###	[CU Main #####]	Internal command error	
Unknown Error: ##	###	[CU Main #####]	Unknown error	

Exporting the log*

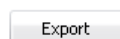

- ▶ Click the "Export" button. The "Save as..." window appears.
- ▶ Enter a file name.
- ▶ Save the file to the desired location.
- ▶ Click "OK". The log is exported as a text file ("*.txt").

* only if you are using the Windows version of the software

Cleaning and maintaining the conference system

CAUTION

Liquids can damage the product!

Liquids entering the product can cause a short-circuit in the electronics or damage the mechanics.

Solvents or cleansing agents can damage the surfaces of the product.

- ▶ Keep all liquids away from the product.
 - ▶ Do not use any solvents or cleansing agents.
-

ADN components

- ▶ Switch the conference system off (see page 77).
- ▶ Before cleaning, disconnect the ADN CU1 central unit, the ADN PS power supplies and the ADN-W AM antenna module from the mains power supply (see page 78).
- ▶ Remove the ADN-W BA battery pack from the ADN-W C1 or ADN-W D1 wireless conference units (see page 47)
- ▶ Only use a dry and soft cloth to clean the products.
- ▶ Clean the grids of the conference units with a soft brush or paintbrush in order to avoid dust deposits.

To ensure optimum cooling of the ADN CU1 central unit and the ADN PS power supplies:

- ▶ Clean the air vents on the front, back and bottom from time to time with a soft brush or paintbrush in order to avoid dust deposits.

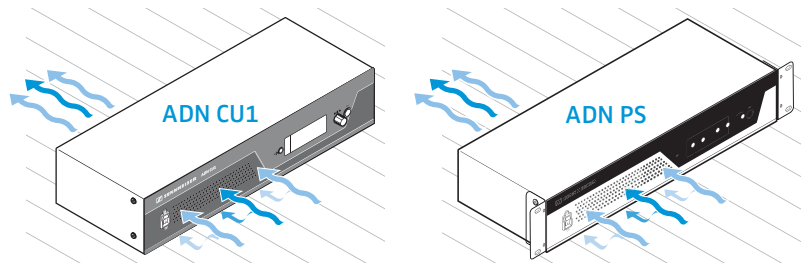

ADN chargers

- ▶ Switch the chargers off (see page 54).
- ▶ Before cleaning, disconnect the chargers from the mains power supply (see page 50).
- ▶ Only use a dry and soft cloth to clean the products.
- ▶ Use for example a paintbrush to remove dust from the charging compartments.

To ensure optimum cooling of the ADN-W L 10 or ADN-W CASE UNITS charger:

- ▶ Clean the air vents on the sides from time to time with a soft brush or paintbrush in order to avoid dust deposits.

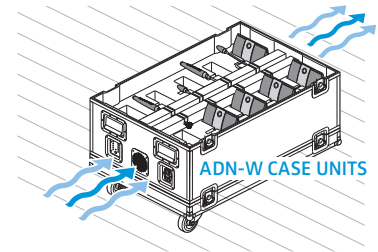
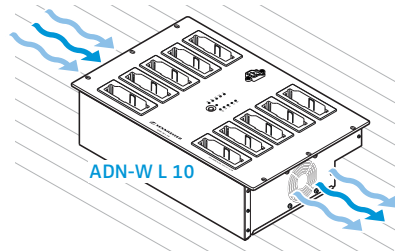

Transporting the wireless components

One of the advantages of wireless components of the ADN conference system is that they are easy to set up and dismantle again. This makes the conference system mobile and ensures flexibility of use.

Preparing the wireless components for transport

- ▶ Unplug all system and mains cables from the ADN CU1 central unit and from the ADN-W AM antenna module.

If you use the wireless conference units together with the ADN-W MIC 36-29 gooseneck microphones:

- ▶ Unscrew the ADN-W MIC 36-29 gooseneck microphones from the conference units (see page 46).

Using the ADN-W CASE transport and charging case

For transporting a wireless conference system, we recommend ADN-W CASE, an optionally available transport and charging case. This modular case allows you to easily and safely transport all components required for a wireless conference system.

Available modules:

- ADN-W CASE BASE case bottom with wheels and case lid
- ADN-W CASE CENTRAL transport case for e.g. central unit, antenna module, ADN-W L 10 charger, power supplies, mains cables and other accessories
- ADN-W CASE UNITS charging case with charging compartments for 10 wireless conference units



CAUTION

Danger of material damage and personal injury during transport!

The modules of the ADN-W CASE transport and charging case can be equipped with the components of the ADN conference system.

Improper lifting or stacking of the individual modules of the transport case can cause personal injury and material damage.

If the transport and charging case tips over, is moved jerkily or not secured against inadvertent rolling, this can cause personal injury and material damage.

- ▶ Lift, shift or move the individual modules of the transport and charging case only when assisted by a second person.
- ▶ Do not stack the modules higher than 1.2 m. This height corresponds to 3 ADN-W CASE UNITS or ADN-W CASE CENTRAL modules plus the ADN-W CASE BASE case bottom and lid.
- ▶ Make sure that the modules are correctly interlocked with each other and that all butterfly locks are properly engaged and locked.
- ▶ Always move the transport and charging case carefully and only on even, horizontal surfaces.
- ▶ Lock the casters of the ADN-W CASE BASE case bottom and use additional securing straps to secure the transport case against inadvertent rolling.

You can stack the individual modules arbitrarily up to a height of 1.2 m.

To stack the modules of the transport and charging case:

- ▶ Open the butterfly locks of the lower module.
- ▶ With the assistance of at least a second person, lift the next module using the foldable carrying handles and place it on the lower module so that the aluminum profiles of the modules engage with each other.
- ▶ Re-engage the 4 butterfly locks of the two modules and turn the butterfly fastener clockwise.
- ▶ Only stack the other modules up to a height of 1.2 m. This height corresponds to 3 ADN-W CASE UNITS or ADN-W CASE CENTRAL modules plus the ADN-W CASE BASE case bottom and lid.

i The butterfly locks can be locked with a small U-lock to prevent inadvertent opening of the modules.

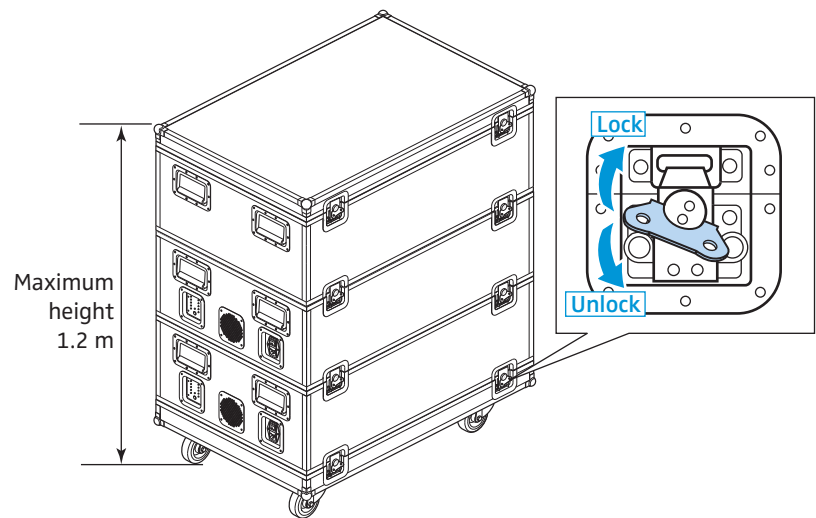

To secure the transport and charging case against inadvertent rolling:

- ▶ Push the locking lever of the casters ③ of the ADN-W CASE BASE case bottom – downwards to lock the casters or – upwards to unlock the casters.
- ▶ If necessary, secure the transport and charging case by means of securing straps that can be attached to the carrying handles.

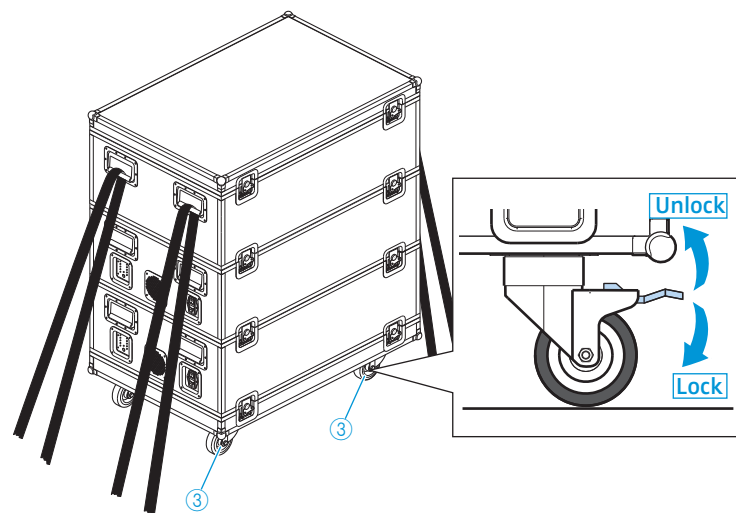

Packing the ADN-W CASE CENTRAL transport case

The module has padded compartments for the following components:

- 1 ADN CU1 central unit
- 1 ADN-W AM antenna mount
- 11 NT 12-50C power supplies
- 1 ADN-W L 10 charger
- 10 ADN-W BA battery packs
- Mains cables and other accessories

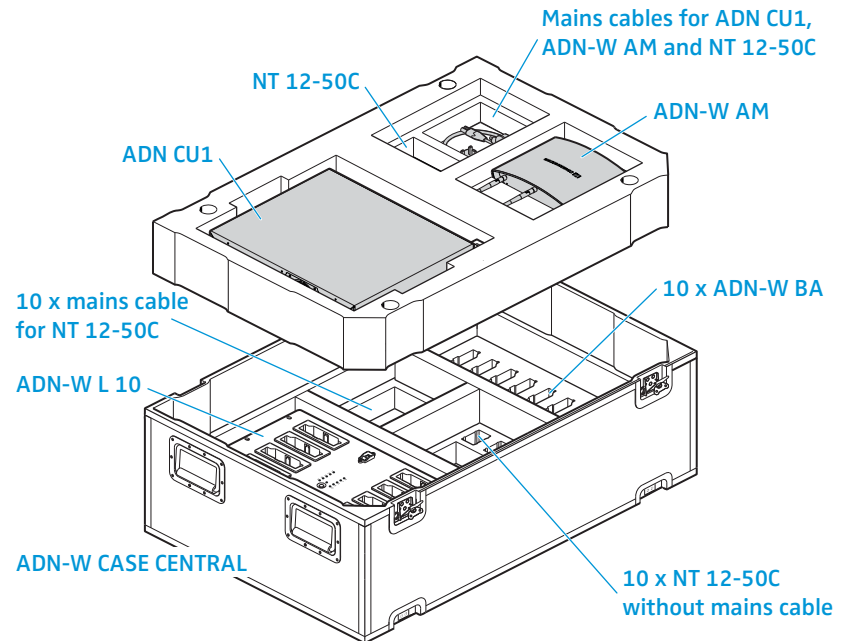

Packing the ADN-W CASE UNITS charging case

The module has padded compartments for 10 ADN-W C1 or ADN-W D1 wireless conference units including their ADN-W BA battery packs and ADN-W MIC 15 or ADN-W MIC 36 gooseneck microphones.

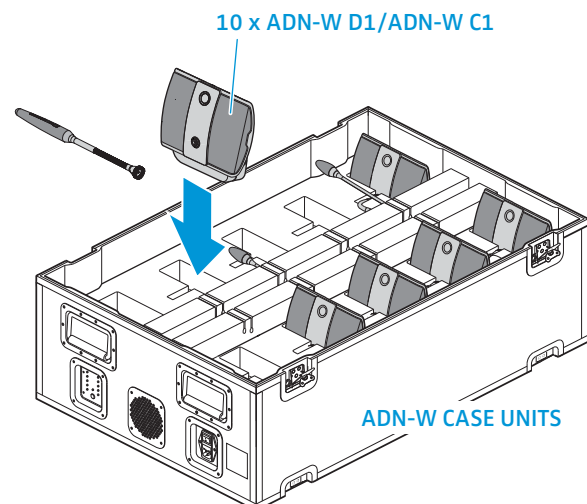

To safely store away the microphones and to insert the goosenecks into the cut-outs of the padded compartments:

- ▶ Carefully bend the ADN-W MIC 15-39, ADN-W MIC 15-50 and ADN-W MIC 36-50 gooseneck microphones sideways.
- ▶ Unscrew the ADN-W MIC 36-29 gooseneck microphones from the conference units (see page 46).

Updating the firmware of the conference system

CAUTION

Danger of damage to the conference system!

Improper modification of the firmware (e.g. due to updates) can cause irreparable damage to the conference system.

- ▶ Only update the firmware if the function of your conference system is impaired or if the update is recommended by Sennheiser.
- ▶ Contact your Sennheiser partner to update the firmware.
- ▶ While the update is in process, do **not** disconnect the ADN CU1 central unit, the ADN PS power supplies and the conference units from the mains power supply.
- ▶ Only update the firmware of the ADN-W D1 or ADN-W C1 wireless conference units when a fully charged ADN-W BA battery pack is installed.

You can display the version numbers of the hardware and software via the central unit's operating menu (see page 111).

Information on the firmware update of the ADN products ("ADN System Update") can be found in the "ADN System Software Setup" manual included on the DVD-ROM (supplied with the central unit) or at www.sennheiser.com.

For further information on firmware updates for your ADN conference system, contact your Sennheiser partner.

If a problem occurs .../Frequently asked questions

Conference system

Problem	Possible cause	Possible solution	See page
ADN CU1 central unit and/or ADN PS power supply cannot be switched on	No connection to the mains power supply	Connect the ADN CU1 central unit and/or the ADN PS power supply to the mains power supply.	39
ADN PS power supply cannot be switched on	No connection to the central unit	Correctly connect the ADN PS power supply to the ADN CU1 central unit and switch the central unit on.	58
ADN PS power supply can be switched on but cannot be detected by the conference system	Too many ADN PS power supplies used in the conference system (the central unit's display panel displays the warning triangle )	You can use a max. of 15 ADN PS power supplies in a conference system. Reduce the number of ADN PS power supplies.	–
Conference unit cannot be used/activated	The conference unit is not connected correctly	Check if all plugs are connected correctly.	56
	The cable string/cable ring is too long	Reduce the length of the cable string/cable ring or reduce the number of conference units.	29
	The maximum number of requests to speak has been reached	Increase the maximum number of requests to speak.	91 and 196
	The ADN C1 chairperson unit has not been initialized before use	If chairperson units are connected afterwards, you have to initialize them.	94 and 191
	Too many ADN C1 chairperson units used in the conference system	You can use a max. of 10 chairperson units in a conference system. Since each chairperson unit reduces the max. possible number of speakers ("Microphone Limit"), reduce the number of ADN C1 chairperson units.	91 and 196
	Too many conference units used in the conference system	You can use a max. of 400 conference units in a conference system. Reduce the number of conference units.	–
	You are using a wireless conference unit and the battery pack is flat	Recharge the ADN-W BA battery pack or replace the flat battery pack by a charged one.	51
	You are using a wireless conference unit – see page 234 for possible problems and solutions	–	–
The central unit's display panel displays error icons/ the display panel lights up red	Changes or errors have occurred	Check the possible causes indicated by the icons.	102
Volume of the conference units' loudspeakers is too high or too low	The processing of the conference units' audio signals ("Audio Gain Reduction") is adjusted so that the gain of each additional channel is reduced too much or too little	Adjust the processing of the conference units' audio signals.	98 and 201
	The floor channel volume is not adjusted correctly	Adjust the floor channel volume.	120, 200 and 214

Problem	Possible cause	Possible solution	See page
Loud hissing at the conference units' loudspeakers	The conference units are placed too close together	Increase the distance between the individual conference units to at least 50 cm.	–
	The floor channel volume is adjusted to a very high level	Reduce the floor channel volume.	120, 200 and 214
	The "Feedback Suppression" function for eliminating feedback is deactivated	Activate the "Feedback Suppression" function ("Low Intensity" or "High Intensity").	99 and 202
Contributions coming from the conference units' microphones are not reproduced via the conference units' built-in loudspeakers and headphones sockets	The "Mic Loudspeaker Mute" function is activated (the conference units' built-in loudspeakers and headphones sockets are deactivated for contributions coming from the conference units' microphones)	Deactivate the "Mic Loudspeaker Mute" function.	100 and 201
The audio signals of the IN audio input are not output at the OUT audio output	The "XLR Mix Minus" function for filtering the audio signals of the IN audio input from the audio signals of the OUT audio output is activated	Deactivate the "XLR Mix Minus" function.	100 and 201
Occurrence of double audio signals during a video- or teleconference	The volume of the conference units' loudspeakers is too high	Reduce the floor channel volume.	120, 200 and 214
	The "XLR Mix Minus" function for avoiding double audio is deactivated	Activate the "XLR Mix Minus" function.	100 and 201
After switch-on, the delegate units only indicate requests to speak	You are using ADN D1/ADN-W D1 delegate units exclusively. The conference mode chosen requires a chairperson unit for granting speaking privileges (e.g. "Request")	Set a conference mode which does not require the grant of speaking privileges.	90 and 195
		Use an ADN C1/ADN-W C1 chairperson unit to grant speaking privileges.	118
		Use the "Conference Manager" software to grant speaking privileges.	211
Delegate unit is automatically deactivated	The speaking time limit is activated	Deactivate or increase the speaking time limit.	92 and 197
	A further speaker has made a request to speak in "Override" mode	Change the conference mode.	90 and 195
		Increase the number of speakers who can take the floor simultaneously.	91 and 196
No request to speak can be made	The maximum number of requests to speak has been reached	Increase the maximum number of requests to speak.	91 and 196
		Wait until one of the current speakers passes on his or her speaking privileges.	–
The signal light ring ② does not flash when a request to speak is made	The function is deactivated	Activate the function.	93 and 197
The number of conference units displayed does not correspond to the number of connected conference units	The conference units have been added to the conference system during operation	Initialize the conference units or switch the conference system on again.	94 and 191
	A cabling error has occurred	Check the conference system for a cabling error.	56

Problem	Possible cause	Possible solution	See page
Conference units are wrongly assigned to the ADN PS power supplies	The conference units have been added to the conference system during operation	Initialize the conference units or switch the conference system on again.	94 and 191
	A cabling error has occurred	Check the conference system for a cabling error.	56
No audio recording on USB mass storage device possible	The data storage device is not formatted	Format the USB mass storage device as NTFS or FAT32 file system	–
	The power supply for the USB mass storage device is not sufficient	Connect the external power supply of the USB mass storage device or use the two USB connections for powering the USB mass storage device.	–
	The data transmission speed is too low	Use a USB mass storage device with USB 2.0 interface.	–
Use a shielded USB cable.		–	
File name of the audio recording does not correspond to the actual date	The date and time on the ADN CU1 central unit are not set correctly	Set the correct date and time.	152

Error messages on the ADN CU1 central unit

Error number	Possible cause	Possible solution	
Unlisted error number	System error	Contact your Sennheiser partner (see page 236).	
60002	Faulty system cable	Replace the faulty system cable and switch the conference system on again (see page 77).	
	Conference units with hardware revision 0 or 1 detected and at least 2 conference units located at the end of a cable string are connected via the OUT socket (or in a ring topology)	Only use conference units with hardware revision 2 (“HW: v2” is printed on the type plate) in a ring topology and/or at the end of a cable string (if connected via the OUT socket).	
60003	Conference units are connected to the DATA socket of an ADN PS power supply	Set up the conference system correctly (see page 56) and switch the conference system on again (see page 77).	
60004	DATA socket of an ADN PS power supply is connected to a PORT socket of an ADN PS power supply		
60005	Ring topology is connected to different PORT sockets of an ADN PS power supply		
60006	Ring topology is connected to different PORT sockets of different ADN PS power supplies		
60007	Ring topology is connected to the ADN CU1 central unit		
60008	Maximum number (500) of connected conference units is exceeded		
60009	At least one serial number of a conference unit appears twice in the system		Check the serial numbers of the conference units or contact your Sennheiser partner (see page 236).
60010	DATA socket of an ADN PS power supply is connected to the antenna module		Set up the conference system correctly (see page 56) and switch the conference system on again (see page 77).

Conference system with wireless conference units

Problem	Possible cause	Possible solution	See page
Antenna module(s) are not active. Wireless conference units flash red continuously. (A warning message appears on the central unit's display panel)	More than 4 antenna modules are connected to an ADN-W CU1 central unit.	Reduce the number of antenna modules. Use a maximum of 4 antenna modules per CU1 central unit.	221
Wireless conference units cannot be logged in and switch off after approx. 5 minutes.	More than 150 wireless conference units are connected to a central unit.	Use a maximum of 150 wireless conference units per ADN-W CU1.	221
Conference unit is active but the microphone does not function	The microphone is wrongly connected	Make sure that the microphone is correctly connected to the console of the wireless conference unit.	46
Newly added conference units do not function. Conference units flash red continuously.	More than 400 conference units are to be connected.	Reduce the number of conference units to a maximum of 400.	–
Microphone LED ⑧ and, if the microphone is power supplied, the signal light ring ② flash red rapidly, the microphone does not function	The microphone is wrongly connected	Make sure that the microphone is correctly connected to the console of the wireless conference unit.	46
	The microphone is defective	Replace the defective microphone by a new one.	–
Conference unit does not connect to the antenna module	The transmission range is exceeded	Reduce the distance between the conference units and the antenna module. Place the antenna module as centrally as possible and above the wireless conference units.	74
	The antenna module checks the frequency ranges.	Wait a few minutes until the frequency ranges have been checked.	
	The access mode is set to "Closed". Only wireless conference units whose serial numbers are listed in a participant list can be used in the wireless conference.	Add the serial number of the wireless conference unit to the participant list.	167
		Set the access mode to "Open" so that the conference units automatically connect to the antenna module.	166
Bad radio link between antenna module and conference units	The transmission range is exceeded	Reduce the distance between the conference units and the antenna module. Place the antenna module as centrally as possible and above the wireless conference units.	74
		Increase the output power to "100%".	163
	The antennas are wrongly oriented or connected	Only use the supplied antennas and correct them correctly to the antenna module. Orient the antennas so that they are parallel to each other and are directed at a 90° angle towards the wireless conference units.	42
	The radio link is subject to interference	Use dynamic frequency management.	96 or 161
RF channels or output power cannot be selected or changed	The software is not in "Live" operating mode	Activate "Live" operating mode in order to manually set the RF channels or the output power.	162

Problem	Possible cause	Possible solution	See page
Country-specific settings ("Country") cannot be changed; "USA/Canada" is selected	If you are using the ADN-W AM-US antenna module that is designed for the North American market, you cannot change the country-specific settings. The conference system only uses frequencies and transmission powers that are approved for the North American market and all other regions		
Settings for wireless conferencing cannot be configured in the "Conference Manager" software	The "Conference Manager" software is not connected to the central unit and/or "Setup" operating mode is activated	Establish a connection between the "Conference Manager" software and the central unit and activate "Live" operating mode in order to configure settings for wireless conferencing.	160

Battery packs and chargers

Problem	Possible cause	Possible solution	See page
Battery pack does not charge	You are using an unsuitable power supply	Only use the NT 12-50C power supply to charge the battery pack.	51
	The battery pack is overheated	Let the battery pack cool down and ensure sufficient ventilation during charging (ambient temperature of 10°C to 45°C). Only use the ADN-W CASE UNITS charging case with the lid open.	51
	The fuse of the ADN-W L 10 or ADN-W CASE UNITS charger has tripped	Contact your Sennheiser partner to find the cause of the problem and to have the fuse replaced.	–
	The battery pack is inserted into the ADN-W L 10 or ADN-W CASE UNITS charger and the NT 12-50C power supply is additionally connected to the battery pack	Charge the battery pack either via the NT 12-50C power supply or the ADN-W L 10 or ADN-W CASE UNITS charger.	51
	The battery pack is defective	Replace the defective battery pack with a new one.	51
Battery charge is quickly used up	The battery pack is overaged	Replace the overaged battery pack with a new one.	–

“Conference Manager” software

Problem	Possible cause	Possible solution	See page
Software cannot be connected to the central unit	No network connection	Check the connections between network, central unit and PC.	76
	The IP address of the central unit or of the Windows PC has been changed	Check the network settings and adjust them if necessary.	127
	There is already a connection to the central unit	Disconnect the connection to the central unit.	155
Screen connected to the central does not show anything	The screen resolution is set too high.	Reset the screen resolution.	143
Network connection between Windows PC and central unit cannot be established	No Zeroconf service installed on the Windows PC	If the PC and the central unit are directly connected to each other, the network configuration is usually done via Zeroconf – not via DHCP. If no Zeroconf service is installed on the PC, install this service or manually assign the route (subnet: 255.255.0.0; IP address range: 169.254.0.x; x = desired IP address of the PC).	–
	Improper IP address allocation to the PC and/or the central unit	Check the network settings and adjust them if necessary.	131
	The network communication between the central unit and the Windows PC is blocked by a proxy server and/or a firewall		
Password forgotten	–	Delete the existing password.	153
Objects in the Room View window cannot be changed	The objects are locked	Unlock the objects.	184
	The software runs in “Live” operating mode	Change to “Setup” operating mode to edit the configuration.	147
Pictures cannot be imported	You are using the central unit’s integrated software	Import pictures using the Windows version of the software.	178
Conference unit icon and participant are not displayed in “Live” operating mode	In the participant list, the “ Show in Live Mode ” check box is deactivated for the participant in question	Activate the “ Show in Live Mode ” check box.	184

If a problem occurs that is not listed in the above table or if the problem cannot be solved with the proposed solutions, please contact your local Sennheiser partner for assistance.

To find a Sennheiser partner in your country, search at www.sennheiser.com under “Service & Support”.

Components and accessories

Central unit/Power supply

Cat. No.	Product name	Description
505553	ADN CU1-EU	Central unit, EU version with EU mains cable
505554	ADN CU1-UK	Central unit, UK version with UK mains cable
505555	ADN CU1-US	Central unit, US version with US mains cable
505546	ADN PS-EU	Power supply, EU version with EU mains cable
505547	ADN PS-UK	Power supply, UK version with UK mains cable
505548	ADN PS-US	Power supply, US version with US mains cable
504031	ADN RMB-2	Rack mount "ears" for rack mounting the ADN CU1 central unit

Wired conference units

Cat. No.	Product name	Description
502758	ADN D1	Delegate unit
502759	ADN C1	Chairperson unit
504001	ADN TR 1	Cable holder for conference unit

Wireless components

Cat. No.	Product name	Description
504748	ADN-W D1	Console of the wireless delegate unit (w/o battery pack and gooseneck microphone)
504745	ADN-W C1	Console of the wireless chairperson unit (w/o battery pack and gooseneck microphone)
504744	ADN-W BA	Battery pack for ADN-W D1/ADN-W C1 wireless conference unit
504750	ADN-W MIC 15-39	Gooseneck microphone for wireless conference unit (length: 39 cm; KE 10 microphone capsule)
504751	ADN-W MIC 36-29	Gooseneck microphone for wireless conference unit (length: 29 cm; ME 36 microphone capsule)
504752	ADN-W MIC 15-50	Gooseneck microphone for wireless conference unit (length: 50 cm; KE 10 microphone capsule)
504753	ADN-W MIC 36-50	Gooseneck microphone for wireless conference unit (length: 50 cm; ME 36 microphone capsule)
505717	ADN-W D1 15-39	Wireless conference unit kit with console of the ADN-W D1 wireless delegate unit, ADN-W BA battery pack and ADN-W MIC 15-39 gooseneck microphone
505718	ADN-W D1 36-29	Wireless conference unit kit with console of the ADN-W D1 wireless delegate unit, ADN-W BA battery pack and ADN-W MIC 36-29 gooseneck microphone
504743	ADN-W AM	Antenna module
505715	ADN-W AM-US	Antenna module, US version

Cat. No.	Product name	Description
505712	NT 12-50C-EU	Power supply for charging one ADN-W BA battery pack and for optionally powering the antenna module, EU version with EU mains cable
505713	NT 12-50C-UK	Power supply, UK version with UK mains cable
505714	NT 12-50C-US	Power supply, US version with US mains cable
003226	GZG 1029	Swivel joint for mounting the antenna module (3/8" thread)
003193	GZP 10	Mounting plate for mounting a swivel joint or the antenna module (3/8" thread)
043207	Thread insert	5/8" to 3/8"
504749	ADN-W L 10	Charger for up to 10 ADN-W BA battery packs (w/o mains cable)
505719	ADN-W L 10-EU	Charger for up to 10 ADN-W BA battery packs, EU version with EU mains cable
505720	ADN-W L 10-UK	Charger for up to 10 ADN-W BA battery packs, UK version with UK mains cable
505721	ADN-W L 10-US	Charger for up to 10 ADN-W BA battery packs, US version with US mains cable
504959	ADN-W CASE BASE	Case lid and case bottom with wheels
504956	ADN-W CASE UNITS	Transport and charging case for 10 wireless conference units (w/o mains cable)
505758	ADN-W CASE UNITS-EU	Transport and charging case for 10 wireless conference units, EU version with EU mains cable
505759	ADN-W CASE UNITS-UK	Transport and charging case for 10 wireless conference units, UK version with US mains cable
505757	ADN-W CASE UNITS-US	Transport and charging case for 10 wireless conference units, US version with US mains cable
504957	ADN-W CASE CENTRAL	Transport case for central unit, antenna module and accessories
505716	ADN-W CASE KIT 20	Transport and charging case kit for 20 wireless conference units (w/o mains cables) with ADN-W CASE BASE case lid and case bottom and 2 ADN-W CASE UNITS charging cases
505756	ADN-W CASE KIT 20-EU	Transport and charging case kit for 20 wireless conference units, EU version with two EU mains cables
505754	ADN-W CASE KIT 20-UK	Transport and charging case kit for 20 wireless conference units, UK version with two UK mains cables
505755	ADN-W CASE KIT 20-US	Transport and charging case kit for 20 wireless conference units, US version with two US mains cables

System cables

Cat. No.	Product name	Description
009842	SDC CBL RJ45-2	System cable with two shielded RJ 45 plugs, black, 2 m
009843	SDC CBL RJ45-3	System cable with two shielded RJ 45 plugs, black, 3 m
009844	SDC CBL RJ45-5	System cable with two shielded RJ 45 plugs, black, 5 m
009845	SDC CBL RJ45-10	System cable with two shielded RJ 45 plugs, black, 10 m
009846	SDC CBL RJ45-20	System cable with two shielded RJ 45 plugs, black, 20 m
009847	SDC CBL RJ45-50	System cable with two shielded RJ 45 plugs, black, 50 m

Specifications

ADN CU1 central unit

Nominal input voltage	100 to 240 V~
Mains frequency	50 to 60 Hz
Power consumption	245 W
Output voltage at RJ45 EtherCAT	52.8 V ===
Nominal output current	max. 1.75 A
Temperature range	operation: +5°C to +50°C storage: -25°C to +70°C
Relative humidity	operation: 10 to 80% storage: 10 to 90%
Dimensions (W x H x D)	approx. 417 x 100 x 345 mm
Weight	approx. 6.5 kg

XLR IN

Input resistance	$R_{IN} > 10 \text{ k}\Omega$
Input level	max. +18 dBu min. -18 dBu
Nominal level	+7.5 dBu

XLR OUT

Output resistance	$R_{OUT} < 100 \Omega$
Frequency response	20 Hz to 14.5 kHz; -3 dB
Output level	max +11 dBu
Nominal level	+6 dBu
THD (at 1 kHz)	< 0.02% A-weighted at +7.5 dBu
Signal-to-noise ratio	> 80 dB A-weighted at +11 dBu

ADN PS power supply

Nominal input voltage	100 to 240 V~
Mains frequency	50 to 60 Hz
Power consumption	385 W
Output voltage at RJ45 PORT I/II output 1/2	52.8 V ===
Nominal output current at RJ45 PORT I/II output 1/2	max. 5.25 A in total max. 1.75 A per output
Output voltage at RJ45 DATA	52.8 V ===
Nominal output current at RJ45 DATA	max. 0.08 A
Temperature range	operation: +5°C to +50°C storage: -25°C to +70°C
Relative humidity	operation: 10 to 80% storage: 10 to 90%
Dimensions (W x H x D)	approx. 482.5 x 168 x 100 mm
Weight	approx. 4.6 kg

ADN D1 and ADN C1 conference units





Supply voltage	35 V to 52.8 V $\overline{=}$
Power consumption	2 W (without reproduction via loudspeakers)
Headphone socket	3.5 mm stereo jack socket
Output level at headphone socket	50 mW/16 Ω
THD (at 1 kHz)	0.03% at 50 mW/16 Ω
Frequency response	100 Hz to 14.5 kHz
Signal-to-noise ratio	> 70 dB(A)
Temperature range	operation: +10°C to +40°C storage: -25°C to +70°C
Relative humidity	operation: 10 to 80% storage: 10 to 90%
Dimensions without gooseneck (W x H x D)	approx. 185 x 63 x 140 mm
Weight	approx. 700 g

Microphone

Pick-up pattern	super-cardioid
Frequency response	190 Hz to 14.5 kHz

Approvals ADN CU1, ADN PS, ADN D1 and ADN C1

In compliance with

Europe	EMC EN 55103-1/-2 Safety EN 60065
	
USA	EMC  47 CFR Part 15 B
Canada	EMCICES 003
Brazil ADN CU1	 Agência Nacional de Telecomunicações  3998-15-7356

Certified by

USA/Canada	Audio, Video and Similar Electronic Apparatus – Safety Requirements CAN/CSA-C22.2 No. 60065 and UL 60065
	

ADN-W AM antenna module

RF frequency ranges	2.4 GHz; 5.1 to 5.9 GHz (see page 251)
RF output power	25 to 100 mW (depending on the selected country/region, see page 251)
Power supply	12 to 15 V === alternatively via ADN PORT bus 52.8 V
Power consumption	6 W
Antennas	3 rod antennas with R-SMA connection
Transmission range	typ. 30 m
Mounting thread	5/8" and 3/8" thread insert
Temperature range	operation: +5°C to +45°C storage: -25°C to +70°C
Relative humidity	operation: 20 to 95% storage: 10 to 90%
Dimensions (W x H x D)	approx. 226 x 181 x 58 mm
Weight	approx. 1660 g

ADN-W C1 and ADN-W D1 wireless conference units

RF frequency ranges	2.4 GHz; 5.1 to 5.9 GHz (see page 251)
RF output power	max. 100 mW (depending on the selected country/region, see page 251)
Audio quality	16 bit / 32 kHz
Operating time	approx. 20 hours (ADN-W BA battery pack)
Voltage of optional external power supply	12 V === via ADN-W BA battery pack
Charging time of battery pack	typ. 4 hours
Headphone socket	3.5 mm stereo jack socket
Output level at headphone socket	50 mW/16 Ω
THD (at 1 kHz)	0.03% at 50 mW/16 Ω
Frequency response	100 Hz to 14.5 kHz
Signal-to-noise ratio	> 70 dB(A)
Temperature range	operation: +5°C to +45°C storage: -25°C to +70°C
Relative humidity	operation: 20 to 80% storage: 10 to 90%
Dimensions without gooseneck (W x H x D)	approx. 185 x 67 x 180 mm
Weight (incl. battery pack)	approx. 940 g

Microphone

See "ADN-W MIC 15 gooseneck microphone for wireless conference units" on page 243.

ADN-W MIC 15 gooseneck microphone for wireless conference units

Pick-up pattern	super-cardioid
Frequency response	190 Hz to 14.5 kHz
Sensitivity (1 kHz)	38 mV/Pa
Signal-to-noise ratio	69 dB
Max. SPL (1 kHz)	120 dB
Temperature range	+10°C to +40°C
Length	ADN-W MIC 15-39: approx. 390 mm ADN-W MIC 15-50: approx. 500 mm
Weight	ADN-W MIC 15-39: approx. 98 g ADN-W MIC 15-50: approx. 116 g
Color	matt black
Windshield	glued

ADN-W MIC 36 gooseneck microphone for wireless conference units

Pick-up pattern	super-cardioid
Frequency response	40 Hz to 20 kHz
Sensitivity (1 kHz)	18 mV/Pa
Signal-to-noise ratio	71 dB
Max. SPL (1 kHz)	130 dB
Temperature range	+10°C to +40°C
Length	ADN-W MIC 36-29: approx. 290 mm ADN-W MIC 36-50: approx. 500 mm
Weight	ADN-W MIC 36-29: approx. 98 g ADN-W MIC 36-50: approx. 116 g
Color	matt black
Windshield	glued

Approvals ADN-W AM, ADN-W D1, ADN-W C1, ADN-W MIC 15 and ADN-W MIC 36

In compliance with

	Europe	EMC	EN 301489-1/-17
		Radio	EN 300328
			EN 301893
			EN 300440-1/-2
		Safety	EN 60065
			EN 62311 (SAR)

Approved by

USA



47 CFR Part 15
FCC ID: DMOADNWAM
FCC ID: DMOADNWDU

Canada

Industry Canada RSS 210
IC: 2099A-ADNWAM
IC: 2099A-ADNWDU

Brazil

ADN-W AM



ADN-W C1



ADN-W D1



ADN-W BA Lithium-Ion battery pack

Nominal output voltage	7.4 V
Capacity	7,800 mAh
Charging voltage	12 V $\overline{=}$
Charging current	2.5 A
Charging time	with a completely discharged battery pack and at room temperature: approx. 100% = typ. 4 hours
Temperature range	operation: +10°C to +45°C storage: -25°C to +70°C Charging: +10 °C to +45 °C
Relative humidity	operation: 20 to 95% storage: 10 to 90%
Dimensions (W x H x D)	approx. 143 x 27 x 124 mm
Weight	approx. 404 g

In compliance with

Europe	EMC	EN 301489-1/-17
	Safety	IEC/EN 62133
USA	UL 1642	Standard for Lithium Batteries
	UL 62133	Standard for Household and Commercial Batteries
UN transportation test	according to UN Manual of Tests and Criteria, Part III, section 38.3 Lithium-Ion batteries	

Certified by

USA/Canada	 E 488750
Japan	

NT 12-50C power supply

Nominal input voltage	100 to 240 V~
Mains frequency	50 to 60 Hz
Nominal output voltage	12 V $\overline{=}$
Nominal output current	max. 5 A
Standby power consumption	≤ 0.5 W
Energy efficiency level (according Energy Star)	V
Temperature range	operation: 0°C to +40°C storage: -10°C to +70°C
Relative humidity	operation: 20 to 95% storage: 10 to 90%
Dimensions (W x H x D)	approx. 115 x 33 x 50 mm

Weight	approx. 280 g
Cable lengths	approx. 1.8 m to mains plug approx. 2.5 m to hollow jack plug

In compliance with

Europe	EMC EN 61204-3 Safety EN 60950-1
USA	EMC  47 CFR Part 15 B Safety CAN/CSA-C22.2 NO. 60950-1
Canada	EMCICES 003 Safety CAN/CSA-C22.2 NO. 60950-1

Certified by

USA/Canada	Audio, Video and Similar Electronic Apparatus – Safety Requirements CAN/CSA-C22.2 No. 60065 and UL 60065
China	China Compulsory Certification
Korea	Korea Certification

ADN-W L 10 charger

Nominal input voltage	100 to 240 V~
Mains frequency	50 to 60 Hz
Power consumption	max. 250 W
Charging voltage	12 V ===
Charging current	max. 10 x 1.6 A
Compatible battery packs	Sennheiser ADN-W BA
Charging time	with a completely discharged battery pack and at room temperature: approx. 100% = typ. 4 hours
Temperature range	operation: +5°C to +45°C storage: -20°C to +70°C
Relative humidity, non-condensing	operation: 20 to 95% storage: 10 to 90%
Dimensions (W x H x D)	approx. 483 x 138 x 310 mm, can be mounted into a 19" rack (7 U)
Weight w/o battery packs	approx. 6.8 kg

ADN-W CASE transport and charging case

ADN-W CASE UNITS

Nominal input voltage	100 to 240 V~
Mains frequency	50 to 60 Hz
Power consumption	max. 250 W
Charging voltage	12 V ===
Charging current	max. 10 x 1.6 A
Temperature range	operation: +5°C to +45°C storage: -20°C to +70°C
Relative humidity, non-condensing	operation: 20 to 95% storage: 10 to 90%
Dimensions (W x H x D)	approx. 931 x 283 x 617 mm
Weight w/o conference units	approx. 16.9 kg

ADN-W CASE CENTRAL

Dimensions (W x H x D)	approx. 931 x 283 x 617 mm
Weight w/o ADN CU1, etc.	approx. 10.9 kg

ADN-W CASE BASE

Case bottom



Dimensions (W x H x D)	approx. 931 x 203 x 617 mm
Weight w/o ADN CU1, etc.	approx. 8.9 kg

Case lid

Dimensions (W x H x D)	approx. 931 x 60 x 617 mm
Weight w/o ADN CU1, etc.	approx. 4 kg

Approvals ADN-W L 10 and ADN-W CASE UNITS

In compliance with

Europe	EMC	EN 301489-1/-17
	Safety	EN 60065
USA	EMC	 47 CFR Part 15 B
	Safety	UL 60065
Canada	EMC	ICES 003
	Safety	CAN/CSA-C22.2 No. 60065

Appendix

Mounting dimensions

ADN CU1

 Make sure that the air vents are not covered or blocked (see page 38).

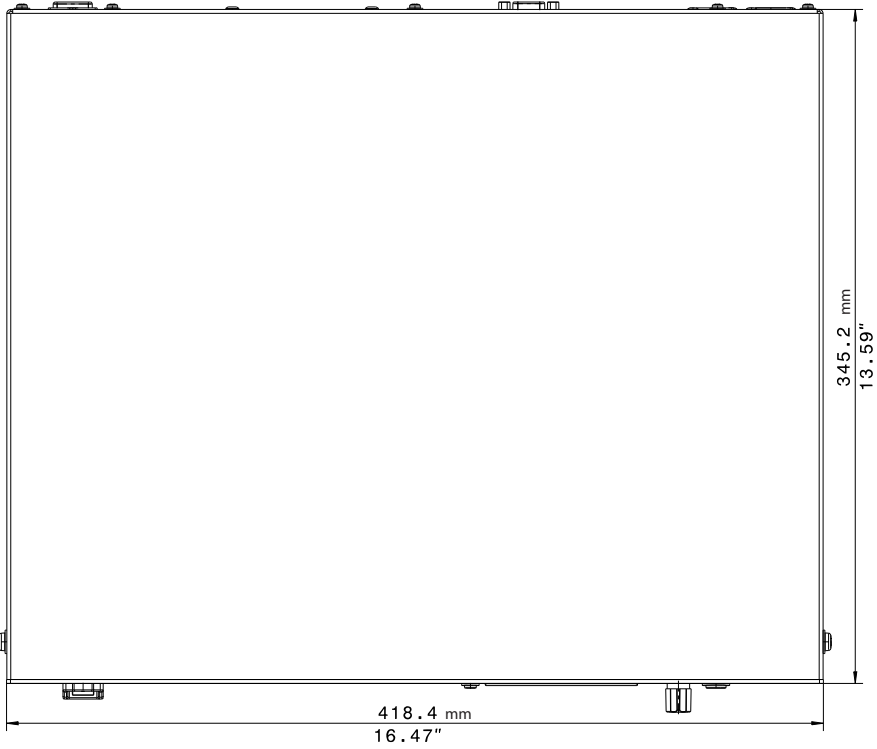
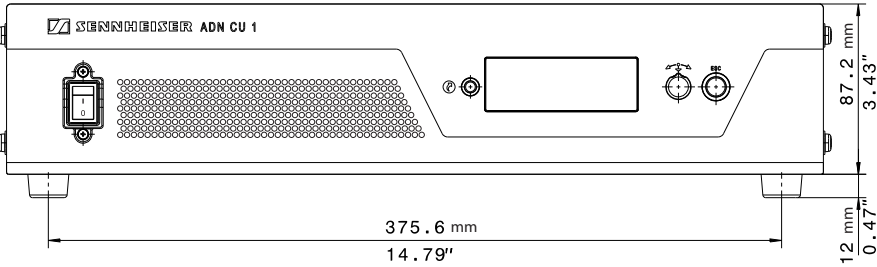

ADN PS



Make sure that the air vents are not covered or blocked (see page 40).

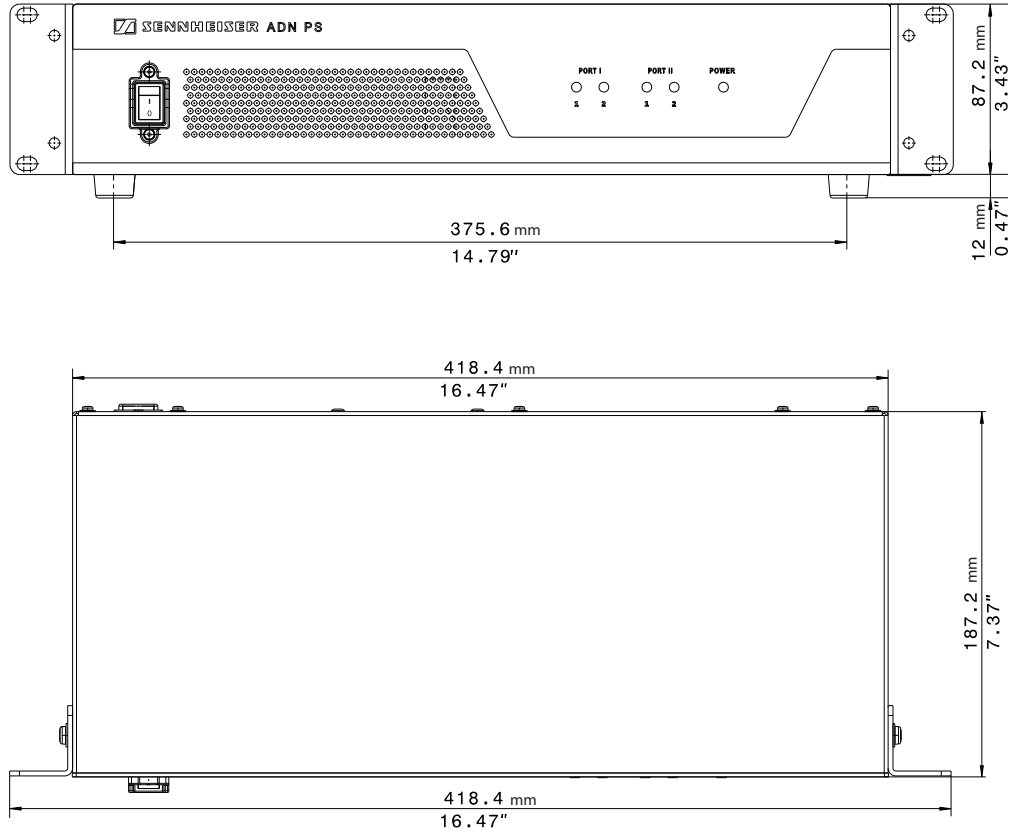

ADN-W AM



Make sure the antennas are not obstructed by any objects and ensure that there is a "free line of sight" between the antennas and the wireless conference units.

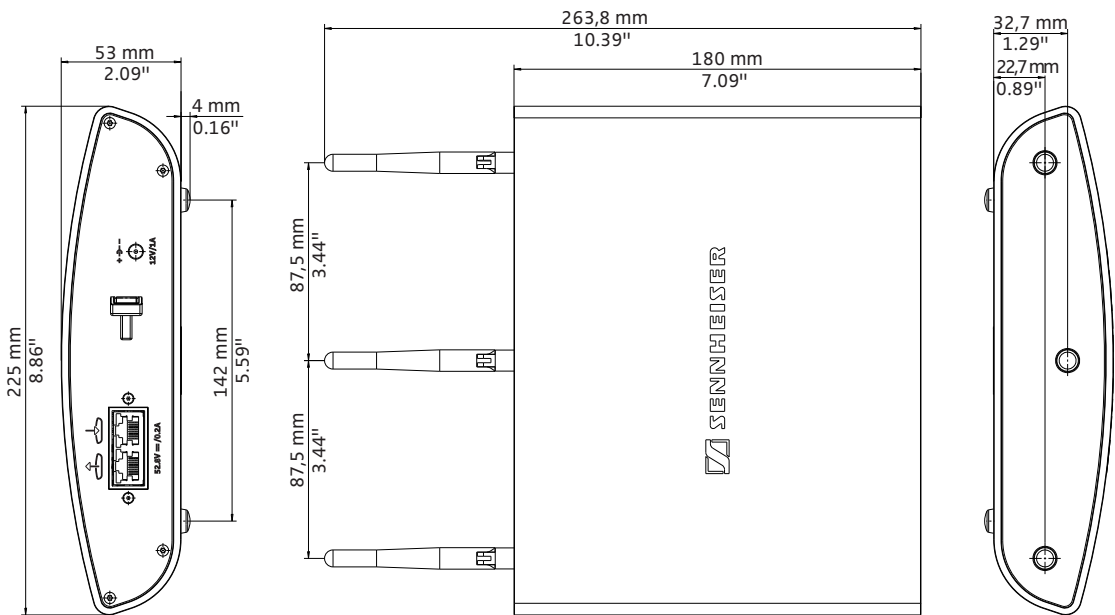

ADN-W L 10



Make sure that the air vents are not covered or blocked (see page 48).

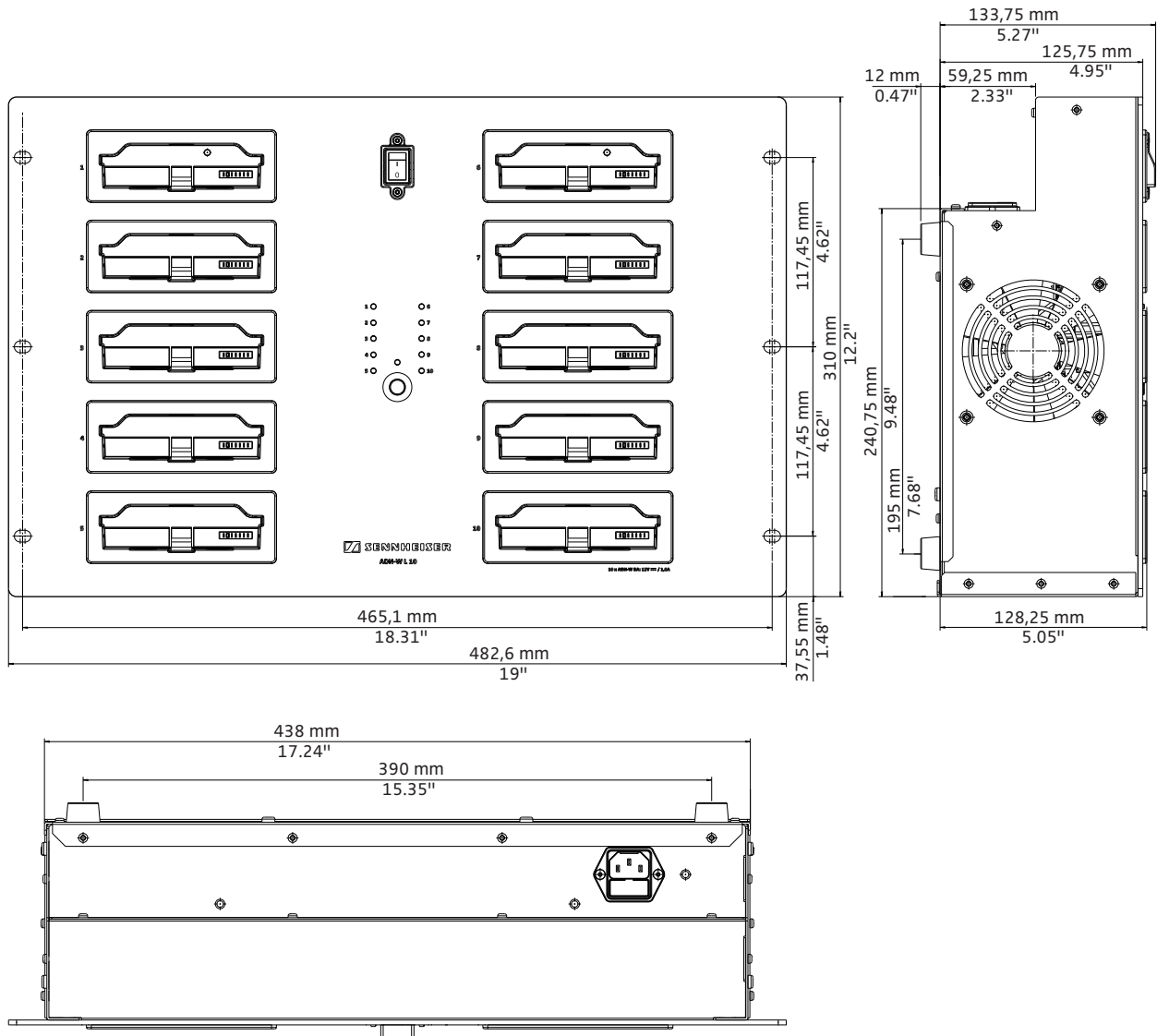

RF channels and transmission powers for wireless conferencing

Channel					Max. transmission power (in mW)					
Frequency band	ADN-W channel number	Center frequency MHz	Frequency range MHz	DFS channel**	Europe	USA/Canada [factory default]	Mexico	Japan	People's Republic of China	Russian Federation
ISM 2.4 GHz	1	2412	2409.5-2414.5	–	25	25	100	25	100	100
	2	2432	2429.5-2434.5	–	25	25	100	25	100	100
	3	2452	2449.5-2454.5	–	25	25	100	25	100	100
	4	2472	2469.5-2474.5	–	25	25	n. a.	25	100	100
RLAN Low 5 GHz*	5	5180	5170-5190	–	100	100	50	100	100	100
	6	5200	5190-5210	–	100	100	50	100	100	100
	7	5220	5210-5230	–	100	100	50	100	100	100
	8	5240	5230-5250	–	100	100	50	100	100	100
RLAN Low 5 GHz (DFS**)	9	5260	5250-5270	✓	100	100	50	100	100	100
	10	5280	5270-5290	✓	100	100	50	100	100	100
	11	5300	5290-5310	✓	100	100	50	100	100	100
	12	5320	5310-5330	✓	100	100	50	100	100	100
RLAN High 5 GHz (DFS**)	13	5500	5490-5510	✓	100	100	100	100	100	n. a.
	14	5520	5510-5530	✓	100	100	100	100	100	n. a.
	15	5540	5530-5550	✓	100	100	100	100	100	n. a.
	16	5560	5550-5570	✓	100	100	100	100	100	n. a.
	17	5580	5570-5590	✓	100	100	100	100	100	n. a.
	18	5600	5590-5610	✓	100	100	n. a.	100	100	n. a.
	19	5620	5610-5630	✓	100	100	n. a.	100	100	n. a.
	20	5640	5630-5650	✓	100	100	n. a.	100	100	n. a.
	21	5660	5650-5670	✓	100	100	100	100	100	n. a.
	22	5680	5670-5690	✓	100	100	100	100	100	n. a.
	23	5700	5690-5710	✓	100	100	100	100	100	n. a.
ISM 5 GHz	24	5745	5735-5755	–	80	80	100	n. a.	100	n. a.
	25	5765	5755-5775	–	80	80	100	n. a.	100	n. a.
	26	5785	5775-5795	–	80	80	100	n. a.	100	n. a.
	27	5805	5795-5815	–	80	80	100	n. a.	100	n. a.
	28	5825	5815-5835	–	80	80	100	n. a.	100	n. a.

Frequency band	Channel				Max. transmission power (in mW)				
	ADN-W channel number	Center frequency MHz	Frequency range MHz	DFS channel**	Brazil	Malaysia	Turkey	Australia & New Zealand	United Arab Emirates
ISM 2.4 GHz	1	2412	2409.5-2414.5	–	100	100	25	100	100
	2	2432	2429.5-2434.5	–	100	100	25	100	100
	3	2452	2449.5-2454.5	–	100	100	25	100	100
	4	2472	2469.5-2474.5	–	100	100	25	100	100
RLAN Low 5 GHz*	5	5180	5170-5190	–	100	100	100	100	100
	6	5200	5190-5210	–	100	100	100	100	100
	7	5220	5210-5230	–	100	100	100	100	100
	8	5240	5230-5250	–	100	100	100	100	100
RLAN Low 5 GHz (DFS**)	9	5260	5250-5270	✓	100	100	100	100	100
	10	5280	5270-5290	✓	100	100	100	100	100
	11	5300	5290-5310	✓	100	100	100	100	100
	12	5320	5310-5330	✓	100	100	100	100	100
RLAN High 5 GHz (DFS**)	13	5500	5490-5510	✓	100	n. a.	100	n. a.	100
	14	5520	5510-5530	✓	100	n. a.	100	n. a.	100
	15	5540	5530-5550	✓	100	n. a.	100	n. a.	100
	16	5560	5550-5570	✓	100	n. a.	100	n. a.	100
	17	5580	5570-5590	✓	100	n. a.	100	n. a.	100
	18	5600	5590-5610	✓	100	n. a.	100	n. a.	100
	19	5620	5610-5630	✓	100	n. a.	100	n. a.	100
	20	5640	5630-5650	✓	100	n. a.	100	n. a.	100
	21	5660	5650-5670	✓	100	n. a.	100	n. a.	100
	22	5680	5670-5690	✓	100	n. a.	100	n. a.	100
	23	5700	5690-5710	✓	100	n. a.	100	n. a.	100
ISM 5 GHz	24	5745	5735-5755	–	100	100	80	100	n. a.
	25	5765	5755-5775	–	100	100	80	100	n. a.
	26	5785	5775-5795	–	100	100	80	100	n. a.
	27	5805	5795-5815	–	100	100	80	100	n. a.
	28	5825	5815-5835	–	100	100	80	100	n. a.

* In some countries/regions (e.g. Canada), the use of wireless components operating in the 5.15 to 5.25 GHz frequency band is restricted to indoor use.

** DFS channels (Dynamic Frequency Selection) are unlicensed frequencies in the 5.260 to 5.825 GHz frequency band that can be occupied by authorized primary users.

If one of the DFS channels is used by a primary user (e.g. radar), this channel cannot be used by the ADN conference system for at least 30 minutes. However, with both manual and automatic channel selection, the ADN conference system automatically switches to an alternate channel. Upon expiry of the legal time frame (30 minutes to 24 hours), the ADN conference system will check if the initially selected DFS channel is again available and will use it if needed.

Factory default settings

Menu item/description	Factory default settings
"Conference Mode" – conference mode	"Direct Access"
"Microphone Limit" – max. number of speakers who can take the floor simultaneously	"4"
"Request Limit" – max. number of requests to speak	"10"
"Talk Time Status" – status of speaking time limit	deactivated ("Off")
"Talk Time Limit" – length of speaking time limit	"60 Min"
"Premonition Time Limit" – advance warning time	"10 Sec"
"Reaction on Talk Time Exceed" – behavior when the individual speaking time is exceeded	microphone is deactivated immediately ("Cancel")
"Blink on Request" – flashing of the signal light ring when a request to speak is made	activated ("On")
"Country" – country/area settings for radio communication	"USA/Canada"
"Output Power" – RF signal strength	"100%"
"Channel Selection" – channel selection mode	"Automatic"
"Access Mode" – connection mode for wireless conference units	"Open"
"XLR Out Status" – audio output	activated ("On")
"XLR Out Volume" – audio output volume	"+ 6 dB"
"XLR OUT Equalizer" – tone color of audio output	0 dB
"XLR In Status" – audio input	activated ("On")
"XLR In Sensitivity" – input sensitivity of audio input	"+ 7.5 dBu"
"XLR IN Equalizer" – tone color of audio input	0 dB
"Floor/Loudspeakers Volume" – floor channel volume	"16"
"Floor/Loudspeakers Equalizer" – tone color of floor channel	0 dB
"Audio Gain Reduction" – processing of the volume level of the floor channel	no reduction ("0.0 dB per Mic")
"XLR Mix Minus" – filtering of the IN audio input from the OUT audio output	deactivated ("Off")
"Mic Loudspeaker Mute" – conference units' built-in loudspeakers do not reproduce contributions coming from the conference units' microphones	deactivated ("Off")
"Feedback Suppression" – "Loudspeaker" – change of the volume adjustment of the conference units' built-in loudspeakers in order to increase the max. possible volume while the risk of feedback due to the increased volume is reduced.	deactivated ("Off")
"Feedback Suppression" – "XLR Out" – change of the volume adjustment of the OUT audio output in order to increase the max. possible volume while the risk of feedback due to the increased volume is reduced.	deactivated ("Off")
"Languages" – Language of the operating menu	"English"
"IP Address Mode" – IP address allocation	"Dynamic IP"
"Contrast" – contrast of the display panel	"9"
"Lock" – lock mode function	deactivated ("Off")
Function of the priority key	requests to speak are deleted ("On")

Keyboard layouts

The central unit supports keyboards with the following language layouts:

- Arabic
- Belgian
- Brazilian
- Bulgarian
- Canadian English
- Canadian French
- Chinese
- Croatian
- Czech
- Danish
- Dutch
- English (UK)
- English (US)
- Estonian
- Farsi
- Finnish
- French
- German
- Greek
- Hebrew
- Hindi
- Hungarian
- Italian
- Japanese
- Korean
- Kannada, Kanarese
- Lithuanian
- Malay
- Norwegian
- Polish
- Portuguese
- Romanian
- Russian
- Slovakian
- Slovenian
- Spanish
- Swedish
- Swiss German
- Swiss French
- Turkic
- Ukrainian

Microsoft Software License Terms

Microsoft Software License Terms for Windows XP Embedded and Windows Embedded Standard Runtime

These license terms are an agreement between you and Sennheiser electronic GmbH & Co. KG (Sennheiser). Please read them. They apply to the software included on this device. The software also includes any separate media on which you received the software.

The software on this device includes software licensed from Microsoft Corporation or its affiliate.

The terms also apply to any Microsoft

- Updates,
- Supplements,
- Internet-based services, and
- Support services

for this software, unless other terms accompany those items. If so, those terms apply. If you obtain updates or supplements directly from Microsoft, then Microsoft, and not Sennheiser, licenses those to you.

As described below, using some features also operates as your consent to the transmission of certain standard computer information for Internet-based services.

By using the software, you accept these terms. If you do not accept them, do not use or copy the software. Instead, contact Sennheiser to determine its return policy for a refund or credit.

If you comply with these license terms, you have the rights below.

1. Use Rights.

You may use the software on the device with which you acquired the software.

2. Additional Licensing Requirements and/or Use Rights.

a. **Specific Use.** Sennheiser designed this device for a specific use. You may only use the software for that use.

b. **Other Software.** You may use other programs with the software as long as the other programs

- Directly support the manufacturer's specific use for the device, or
- Provide system utilities, resource management, or anti-virus or similar protection.

Software that provides consumer or business tasks or processes may not be run on the device. This includes email, word processing, spreadsheet, database, scheduling and personal finance software. The device may use terminal services protocols to access such software running on a server.

c. Device Connections.

- You may use terminal services protocols to connect the device to another device running business task or processes software such as email, word processing, scheduling or spreadsheets.
- You may allow up to ten other devices to access the software to use
- File Services,

- Print Services,
- Internet Information Services, and
- Internet Connection Sharing and Telephony Services.

The ten connection limit applies to devices that access the software indirectly through "multiplexing" or other software or hardware that pools connections. You may use unlimited inbound connections at any time via TCP/IP.

3. **Scope of License.** The software is licensed, not sold. This agreement only gives you some rights to use the software. Sennheiser and Microsoft reserve all other rights. Unless applicable law gives you more rights despite this limitation, you may use the software only as expressly permitted in this agreement. In doing so, you must comply with any technical limitations in the software that allow you to use it only in certain ways. For more information, see the software documentation or contact Sennheiser. Except and only to the extent permitted by applicable law despite these limitations, you may not:

- Work around any technical limitations in the software;
- Reverse engineer, decompile or disassemble the software;
- Make more copies of the software than specified in this agreement;
- Publish the software for others to copy;
- Rent, lease or lend the software; or
- Use the software for commercial software hosting services.

Except as expressly provided in this agreement, rights to access the software on this device do not give you any right to implement Microsoft patents or other Microsoft intellectual property in software or devices that access this device.

You may use remote access technologies in the software such as Remote Desktop to access the software remotely from another device. You are responsible for obtaining any licenses required for use of these protocols to access other software.

- **Remote Boot Feature.** If the Sennheiser enabled the device Remote Boot feature of the software, you may
 - (i) use the Remote Boot Installation Service (RBIS) tool only to install one copy of the software on your server and to deploy the software on licensed devices as part of the Remote Boot process; and
 - (ii) use the Remote Boot Installation Service only for deployment of the software to devices as part of the Remote Boot process; and
 - (iii) download the software to licensed devices and use it on them.

For more information, please refer to the device documentation or contact Sennheiser.

- **Internet-Based Services.** Microsoft provides Internet-based services with the software. Microsoft may change or cancel them at any time.

- a. **Consent for Internet-Based Services.** The software features described below connect to Microsoft or service provider computer systems over the Internet. In some cases, you will not receive a separate notice when they connect. You may switch off these features or not use them. For more information about these features, visit <http://www.microsoft.com/windowsxp/downloads/updates/sp2/docs/privacy.msp>.

By using these features, you consent to the transmission of this information. Microsoft does not use the information to identify or contact you.

- b. **Computer Information.** The following features use Internet protocols, which send to the appropriate systems computer information, such as your Internet protocol address, the type of operating system, browser and name and version of the software you are using, and the language code of the device where you installed the software. Microsoft uses this information to make the Internet-based services available to you.

- **Web Content Features.** Features in the software can retrieve related content from Microsoft and provide it to you. To provide the content, these features send to Microsoft the type of operating system, name and version of the software you are using, type of browser and language code of the device where the software was installed. Examples of these features are clip art, templates, online training, online assistance and Appshelp. These features only operate when you activate them. You may choose to switch them off or not use them.

- **Digital Certificates.** The software uses digital certificates. These digital certificates confirm the identity of Internet users sending X.509 standard encrypted information. The software retrieves certificates and updates certificate revocation lists. These security features operate only when you use the Internet.

- **Auto Root Update.** The Auto Root Update feature updates the list of trusted certificate authorities. You can switch off the Auto Root Update feature.

- **Windows Media Player.** When you use Windows Media Player, it checks with Microsoft for
 - Compatible online music services in your region;
 - New versions of the player; and
 - Codecs if your device does not have the correct ones for playing content. You can switch off this feature. For more information, go to: <http://microsoft.com/windows/windowsmedia/mp10/privacy.aspx>.

- **Windows Media Digital Rights Management.** Content owners use Windows Media digital rights management technology (WMDRM) to protect their intellectual property, including copyrights. This software and third party software use WMDRM to play and copy WMDRM-protected content. If the software fails to protect the content, content owners may ask Microsoft to revoke the software's ability to use WMDRM to play or copy protected content. Revocation does not affect other content. When you download licenses for protected content, you agree that Microsoft may include a revocation list with the licenses. Content owners may require you to upgrade WMDRM to access their content. Microsoft software that includes WMDRM will ask for your consent prior to the upgrade. If you decline an upgrade, you will not be able to access content that requires the upgrade. You may switch off WMDRM features that access the Internet. When these features are off, you can still play content for which you have a valid license.

- c. **Misuse of Internet-based Services.** You may not use these services in any way that could harm them or impair anyone else's use of them. You may not use the services to try to gain unauthorized

access to any service, data, account or network by any means.

4. Windows Update Agent (also known as Software Update Services). The software on the device includes Windows Update Agent ("WUA") functionality that may enable your device to connect to and access updates ("Windows Updates") from a server installed with the required server component. Without limiting any other disclaimer in this Microsoft Software License Terms or any EULA accompanying a Windows Update, you acknowledge and agree that no warranty is provided by MS, Microsoft Corporation or their affiliates with respect to any Windows Update that you install or attempt to install on your device.

5. Product Support. Contact Sennheiser for support options. Refer to the support number provided with the device.

6. Backup Copy. You may make one backup copy of the software. You may use it only to reinstall the software on the device.

7. Proof Of License. If you acquired the software on the device, on a disc or other media, a genuine Certificate of Authenticity label with a genuine copy of the software identifies licensed software. To be valid, this label must be affixed to the device, or included on or in Sennheiser's software packaging. If you receive the label separately, it is not valid. You should keep the label on the device or packaging to prove that you are licensed to use the software. To identify genuine Microsoft software, see <http://www.howtotell.com>.

8. Transfer to a Third Party. You may transfer the software only with the device, the Certificate of Authenticity label, and these license terms directly to a third party. Before the transfer, that party must agree that these license terms apply to the transfer and use of the software. You may not retain any copies of the software including the backup copy.

9. Not Fault Tolerant. The software is not fault tolerant. Sennheiser installed the software on the device and is responsible for how it operates on the device.

10. Restricted Use. The Microsoft software was designed for systems that do not require fail-safe performance. You may not use the Microsoft software in any device or system in which a malfunction of the software would result in foreseeable risk of injury or death to any person. This includes operation of nuclear facilities, aircraft navigation or communication systems and air traffic control.

11. No Warranties for the Software. The software is provided "as is". You bear all risks of using it. Microsoft gives no express warranties, guarantees or conditions. Any warranties you receive regarding the device or the software do not originate from, and are not binding on, Microsoft or its affiliates. When allowed by your local laws, Sennheiser and Microsoft exclude implied warranties of merchantability, fitness for a particular purpose and non-infringement.

12. Liability Limitations. You can recover from Microsoft and its affiliates only direct damages up to two hundred fifty U.S. Dollars (U.S. \$250.00). You cannot recover any other damages, including consequential, lost profits, special, indirect or incidental damages.

This limitation applies to:

- Anything related to the software, services, content (including code) on third party internet sites, or third party programs; and
- Claims for breach of contract, breach of warranty, guarantee or condition, strict liability, negligence, or other tort to the extent permitted by applicable law.

It also applies even if Microsoft should have been aware of the possibility of the damages. The above limitation may not apply to you because your country may not allow the exclusion or limitation of incidental, consequential or other damages.

13. Export Restrictions. The software is subject to United States export laws and regulations. You must comply with all domestic and international export laws and regulations that apply to the software. These laws include restrictions on destinations, end users and end use. For additional information, see www.microsoft.com/exporting.

Manufacturer Declarations

Warranty

Sennheiser electronic GmbH & Co. KG gives a warranty of 24 months on this product.

For the current warranty conditions, please visit our website at www.sennheiser.com or contact your Sennheiser partner.

In compliance with the following requirements



- Battery Directive (2013/56/EU)
The supplied rechargeable batteries or batteries can be recycled. Please dispose of them as special waste or return them to your specialist dealer. In order to protect the environment, only dispose of exhausted batteries.
- China RoHS Directive

Product	China RoHS
ADN-W BA	
ADN C1/D1 ADN CU1 ADN PS ADN-W C1/D1 ADN-W AM ADN-W CASE UNITS ADN-W L 10 ADN-W MIC 15-39 and 15-50 ADN-W MIC 36-29 and 36-50	

CE Declaration of Conformity



- EMC Directive (2014/30/EU)
- Radio Equipment Directive (2014/53/EU)
- Low Voltage Directive (2014/35/EU)
- RoHS Directive (2011/65/EU)

The declaration is available at www.sennheiser.com/download

Before putting the products into operation, please observe the respective country-specific regulations.

Statements regarding FCC and Industry Canada for ADN CU1, ADN PS, ADN-W L 10 and ADN-W CASE UNITS

This device complies with Part 15 of the FCC Rules and with RSS-210 of Industry Canada. Operation is subject to the following two conditions: (1) this device may not cause harmful interference, and (2) this device must accept any interference received, including interference that may cause undesired operation.

The device for operation in the band 5150-5250 MHz is only for indoor use to reduce the potential for harmful interference to co-channel mobile satellite systems.

This equipment has been tested and found to comply with the limits for a Class B digital device, pursuant to part 15 of the FCC Rules. These limits are designed to provide reasonable protection against harmful interference in a residential installation. This equipment generates, uses and can radiate radio frequency energy and, if not installed and used in accordance with the instructions, may cause harmful interference to radio communications. However, there is no guarantee that interference will not occur in a particular installation. If this equipment does cause harmful interference to radio or television reception, which can be determined by turning the equipment off and on, the user is encouraged to try to correct the interference by one or more of the following measures:

- Reorient or relocate the receiving antenna.
- Increase the separation between the equipment and receiver.
- Connect the equipment into an outlet on a circuit different from that to which the receiver is connected.
- Consult the dealer or an experienced radio/ TV technician for help.

Changes or modifications made to this equipment not expressly approved by Sennheiser electronic Corp. may void the FCC authorization to operate this equipment.

This Class B digital apparatus complies with the Canadian ICES-003.

Trademarks

Sennheiser is a registered trademark of Sennheiser electronic GmbH & Co. KG.

Other product and company names mentioned in the ADN instruction manuals may be the trademarks or registered trademarks of their respective holders.

Index – ADN conference system

This is an index (in alphabetical order) to the terms of the ADN conference system. Terms relating to the “Conference Manager” software can be found in a separate index (see page 263).

A

- Accessories 237
 - Activating the filtering of the IN audio input from the OUT audio output 100
 - Activating/deactivating the flashing of the signal light ring when a request to speak is made 197
 - Adding
 - conference units 121
 - ADN C1, *see* Chairperson unit, wired conference unit and conference unit
 - ADN Cable Calculator 35
 - installing the software 35
 - system requirements 35
 - uninstalling the software 37
 - using the software 37
 - ADN CU1 display panel, *see* Display panel
 - ADN CU1, *see* Central unit
 - ADN D1, *see* Delegate unit and conference unit
 - ADN PS power supply
 - connecting the antenna module 67
 - connecting to the central unit 58
 - connecting wired conference units 58
 - disconnecting from the mains power supply 79
 - overview 23
 - status LEDs 23
 - switching off 78
 - switching on 77
 - ADN-W AM, *see* Antenna module
 - ADN-W BA, *see* Battery pack
 - ADN-W C1, *see* Chairperson unit, wireless conference unit and conference unit
 - ADN-W CASE, *see* Transport
 - ADN-W D1, *see* Delegate unit, wireless conference unit and conference unit
 - ADN-W L 10 charger
 - charging the battery pack 52
 - connecting to the mains power supply 49
 - disconnecting from the mains power supply 49
 - mounting into a 19" rack 48
 - overall monitoring/individual compartment monitoring 54
 - overview 24
 - setting up 48
 - status display 54
 - switching off 54
 - switching on 53
 - troubleshooting 235
 - ADN-W MIC 15, *see* Gooseneck microphone
 - ADN-W MIC 36, *see* Gooseneck microphone
 - ADN-W CASE UNITS charging case
 - charging the battery pack 53
 - connecting to the mains power supply 50
 - disconnecting from the mains power supply 50
 - overall monitoring/individual compartment monitoring 54
 - overview 27
 - setting up 49
 - status display 54
 - switching off 54
 - switching on 53
 - troubleshooting 235
- Advance warning time
 - setting 92, 197
 - Antenna module
 - connecting the antennas 42
 - connecting to the central unit 66
 - connecting to the mains power supply 43
 - list of RF channels 251
 - mounting to a stand 72
 - mounting to the ceiling 72
 - mounting to the wall 71
 - orienting the antennas 73
 - overview 18
 - placing on a flat surface 73
 - positioning 69
 - preparing for operation 42
 - setting up 69
 - switching off 79
 - switching on 78
 - Approvals 241, 243, 247
 - Audio devices
 - connecting to the central unit 75
 - Audio Gain Reduction 98
 - Audio IN and Audio OUT 75, 97
 - adjusting audio settings 202
 - Audio settings
 - adjusting 97, 202
 - resetting 202
 - Avoiding echoes 100

B

- Battery pack
 - behavior during charging 55
 - charging 51
 - charging using the ADN-W CASE UNITS charging case 53
 - charging using the ADN-W L 10 charger 52
 - charging using the NT 12-50C power supply 52
 - checking the charge status 51
 - inserting 47
 - operating time 51
 - overview 16
 - removing 47
 - status LEDs 16
 - troubleshooting 235
- Battery, *see* Battery pack
- Behavior when the speaking time limit is exceeded
 - setting 93, 198
- Blink on Request 93, 197
- Break Counter 109
 - resetting 110
- Bus Statistics 109

C

- Cable holder
 - cable holder 44
- Cable string, *see* String cabling
- Cancel function 119
- Central unit
 - adjusting further settings 113
 - adjusting the date and time 152
 - Audio IN and Audio OUT 75
 - connecting an ADN PS power supply 58
 - connecting external audio devices 75
 - connecting the antenna module 66
 - connecting to a PC 76
 - connecting to the mains power supply 39
 - disconnecting from the mains power supply 79
 - display panel 21
 - function of the keys 83
 - language 113
 - mounting into a 19" rack 38
 - network settings 113
 - operating menu 84
 - overview 20
 - setting up 38
 - switching on/off 77
 - using 83
- Chairperson unit
 - activating the microphone 116
 - configuring the priority key 94
 - connecting to the central unit 57, 58
 - deactivating the microphone 117, 211
 - ending a conference 119
 - granting speaking privileges 118
 - initializing 94, 189
 - muting all delegate units 119
 - operating 118
 - overview (wired) 13
 - overview (wireless) 15
 - preparing for operation (wired) 44
 - preparing for operation (wireless) 46
 - setting the volume 120
- Cleaning 225
- Clear Request List on Cancel 94
- Components 237
 - overview 10
 - package contents 8
- Conference Manager
 - connecting the central unit to a PC 76
 - devices required for use with the central unit 76
 - functionality 34
 - preparing for use 76
 - running on a separate Windows PC 76
 - running on the central unit 76
 - see also* Index of Conference Manager software
 - using 125
- Conference mode
 - Direct Access 90
 - Override 90
 - Push To Talk 90
 - Request 90
 - setting 90, 195
- Conference settings
 - adjusting 90

- Conference system
 - checking and detecting errors 102
 - cleaning and maintaining 225
 - configuring 90
 - configuring via central unit 84
 - error icons 102
 - performing a self-test 110
 - putting into operation 38
 - setting up 56
 - structuring and controlling 28
 - switching on/off 77
 - updating the firmware 230
- Conference unit
 - adding to the conference system during operation 121
 - behavior of signal light ring 93
 - changing the numbering 192
 - connecting to the central unit 57, 58
 - deactivating the microphone 117, 211
 - initializing 94, 189
 - number 106
 - operating 116
 - overview (wired) 13
 - overview (wireless) 14, 15
 - setting the volume 120
 - setting up (wired) 56
 - setting up (wireless) 74
 - taking the floor/making a request to speak 116
 - using headphones 117
- Configuring
 - via central unit 84
 - via Conference Manager software 125
- Connecting
 - conference units to the central unit 57, 58
 - Windows PC to the central unit 76
 - wireless conference units to the antenna module 78
- Current and power supply 107

D

- Deactivating the conference units' built-in loudspeakers for contributions coming from the conference units' microphones 100, 201

Delegate unit

- activating the microphone 116, 211
- connecting to the central unit 57, 58
- deactivating the microphone 117
- initializing 94, 189
- operating 116
- overview (wired) 12
- overview (wireless) 14
- preparing for operation (wired) 44
- preparing for operation (wireless) 46
- setting the volume 120

DFS channels 163

Diagnostics 107

Direct Access 90

Display panel

- overview 21

E

Equalizer

- Audio IN and Audio OUT 202

- floor channel 98
- Error icons
 - cable fault icon 102
 - short-circuit icon 102
 - structural change icon 102
 - warning triangle 102
- Error indication 109
- Errors
 - current and power supply 107
 - detecting and eliminating 102
 - Reset Error Indication 111
 - resetting the counter 110
 - short-circuit 107
 - system analysis 107
 - system bus errors 109
 - temperature 108
- F**
- Factory default settings 114, 253
- Feedback
 - eliminating 99, 202
- Feedback Suppression 99, 202
- Firmware 230
- Floor channel
 - adjusting audio settings 98
 - recording 122
 - setting the volume 98, 120
- Floor/Loudspeakers 98
- Further settings 113
- G**
- Gooseneck microphone
 - function check 46
 - overview 17
- H**
- Headphones
 - connecting 117
 - setting the headphone volume 117
- Hybrid operation 33, 67
- I**
- Initializing
 - conference units 94, 189
- Interference
 - RF signal 71
- L**
- Language
 - adjusting 113
- Linear Division 98
- Lithium-Ion battery pack, *see* Battery pack
- Lock mode
 - activating/deactivating 114
 - deactivating 83
- M**
- Manufacturer Declarations 257
- Max. number of conference units 28
- Max. number of requests to speak
 - setting 91, 196
- Max. number of speakers
 - setting 91, 196
- Media control system 34
 - connecting 80
 - connecting to the central unit 80
 - programming 80
 - using 80
- Menu, *see* Operating menu
- Mic Loudspeaker Mute 100, 201
- Microphone
 - activating 116
 - deactivating 117
- Microphone Limit 91, 196
- N**
- Network settings 113
 - configuring Windows 131
- Network settings for Windows 7
 - dynamic IP addressing 137
 - static IP addressing 138
- Network settings for Windows 8
 - dynamic IP addressing 141
 - static IP addressing 142
- Network settings for Windows Vista
 - dynamic IP addressing 135
 - static IP addressing 135
- Network settings for Windows XP
 - dynamic IP addressing 132
 - static IP addressing 133
- Next key 118
- Number of connected conference units 106
- O**
- Operating menu
 - functionality 34
 - overview 84
 - working with the operating menu 88
- Output Power 163
- Override 90
- Overview
 - operating menu of the central unit 84
- P**
- Package contents 8
- PC
 - connecting to the central unit 76
 - system requirements 127
- Port I and II
 - connected topologies 106
 - number and type of connected conference units 106
- Premonition Time Limit 92, 197
- Priority function 119
- Priority key
 - setting the function 94

Processing of the conference units' audio signals
 adjusting 98
 Push To Talk 90

R

Rack mounting 38
 fastening the rack mount "ears" 39
 Radio frequencies 251
 Radio settings, *see* Wireless conferencing
 Reaction on Talktime Exceed 93, 198
 Recording 122
 Redundant cabling 31
 Re-Init 94
 Request 90
 Request Limit 91, 196
 Request to speak
 canceling 117
 Reset Break Indication 110
 Ring topology 31
 Running the software
 on a separate Windows PC 76
 on the central unit 76

S

SDC CBL RJ-45, *see* System cables
 Setting up a conference system
 basic requirements for setting up a conference system
 comprising wireless conference units 32
 controlling the conference system 34
 hybrid operation 33, 67
 large wired conference system 30
 large wired conference system with redundant ring
 topology 31
 small wired conference system 29
 wireless conference system 32
 Signal light ring
 activating/deactivating the flashing 93
 Software
 preparing for use 76
 Software, *see* Conference Manager
 Speaking privileges
 granting 118, 211
 requesting 116
 Speaking time limit
 activating/deactivating 92, 197
 setting 92, 197
 Specifications 240
 Start Self-Test 110
 String cabling 57, 58
 Structuring
 conference system 28
 Switching on/off
 conference system 77
 System analysis 107
 System bus errors
 displaying 109
 System cables 24, 239
 calculating the cable lengths 37
 connecting to the central unit 57, 58

System Load 107

T

Talk Time Limit 92, 197
 Talk Time Status 92
 Temperature status
 displaying 108
 Transport 227
 packing the modules of the transport case 229
 stacking the modules of the transport case 228
 Troubleshooting
 ADN-W L 10 charger 235
 ADN-W CASE UNITS charging case 235
 battery pack 235
 conference system 231

U

Units 106
 * (asterisk) next to Units 106
 Update 230
 USB mass storage device
 recording a conference 122

V

Version 230
 displaying the hardware and software version 111
 Voice echo, *see* Avoiding echoes
 Voltage drop 28
 ADN Cable Calculator 28
 calculating 28
 Volume
 floor channel 98
 increasing 99, 202
 setting 98, 120

W

Warranty 257
 Wireless conference system
 switching on 78
 Wireless conference unit
 deactivating manual switch-off 171
 overview of ADN-W C1 15
 overview of ADN-W D1 14
 setting up 74
 switching off 79
 switching on 78
 Wireless conferencing
 configuring the wireless components 81
 DFS channels 163
 mounting instructions 69
 setting the RF signal strength 163
 transmission range 69

X

XLR Mix Minus 100

Index – “Conference Manager” software

This is an index (in alphabetical order) to the terms of the “Conference Manager” software. Terms relating to the ADN conference system can be found in a separate index (see page 259).

A

- Access Mode 165
- Activating the filtering of the IN audio input from the OUT audio output 201
- Activating/deactivating the flashing of the signal light ring when a request to speak is made 197
- Active conference 156
- Adjusting
 - audio settings 199
 - date and time 152
 - keyboard layout 152
 - language 152
 - network settings on the central unit 153
 - screen resolution 151
 - settings during a running conference 214
- Advance warning time
 - setting 197
- All Micros OFF 198
- Assigning participant names to the conference units 193
- Audio Gain Reduction 201
- Audio IN and Audio OUT
 - adjusting audio settings 199
- Audio settings
 - adjusting 199
- Autoload 157
- Avoiding echoes 201

B

- Bar graphs
 - overview 208
- Battery Status 209
- Behavior when the speaking time limit is exceeded
 - setting 198
- Blink on Request 197
- Buttons for selecting the operating mode 147
- Buttons for selecting the views 146

C

- Canvas
 - changing the font type 178
 - changing the size 183
 - enlarging 182
 - locking library panels 184
 - locking objects 184
 - placing text 178
- Central unit
 - configuring the screen, mouse, and keyboard settings 151
 - connecting to the Conference Manager software 126, 154
- Channel Selection 161
- Closed access mode 165
- Columns
 - adjusting the width 150
 - showing/hiding 150

- Conference
 - configuring 195
 - controlling 125
 - Direct Access 195
 - monitoring 205
 - opening 156
 - Override 195
 - planning and simulating 125
 - preparing 195
 - Push To Talk 195
 - Request 195
 - setting the conference mode 195
 - wireless conferencing 160
- Conference Manager
 - “Setup” operating mode 172
 - connecting to the central unit 154
 - creating graphical representations 174
 - creating photographic representations 172
 - installing 127
 - main window 144
 - mapping a room 174
 - running on a separate Windows PC 125, 127
 - running on the central unit 125, 126
 - uninstalling 130
 - using 125
 - using image files 178
- Conference mode
 - setting 195
- Conference settings
 - adjusting 195
- Conference system
 - configuring 195
- Conference unit
 - adding 213
 - adding a participant name 193
 - automatic initialization 189
 - icons 189
 - initializing 189
 - initializing all 191
 - manual initialization 190
 - manual initialization of a selection 191
- Conference unit icon 189
 - overview 207
 - question mark 207
 - warning triangle 207
- Configuration
 - automatically loading 157
 - closing 159
 - creating 155
 - deleting 159
 - loading 156
 - opening 156
 - saving 157
- Configuring
 - screen, mouse, and keyboard settings 151
 - via software 195

- Connect to CU 154
- Connecting
 - software to the central unit 126, 154
- Connection
 - between software and conference system 126
 - disconnecting 155
 - eliminating problems when a configuration is autoloaded 157
- Controlling a conference
 - granting/withdrawing speaking privileges 211
- Controlling a running conference 204

- D**
- Date and time
 - adjusting 152
- Delegate View window 146, 204
- Direct Access 195

- E**
- “Event Log” 219
- Equalizer
 - floor channel 200
- Exiting
 - “Live” operating mode 216
 - the central unit’s integrated software 143
 - the Windows version of the software 143
- Exporting
 - log 224
 - participant list 188

- F**
- Floor channel
 - adjusting audio settings 199, 200
 - setting the volume 200
- Floor/Loudspeakers 200
- Full screen mode 151

- G**
- Getting to know and adjusting basic features 144
- Grid lines 183

- H**
- Hardware platform 125

- I**
- Importing
 - image files 179
 - participant list 188
- Initialization 189
- Installing the software 127

- K**
- Keyboard layout 152

- L**
- “Live” operating mode 125, 203
 - controlling a conference 203
 - exiting 216
 - monitoring a conference 203
 - starting/ending a conference 203
- Language
 - adjusting 152
- Linear Division 201
- Loading
 - configuration 156
 - file 156
- Lock mode
 - activating/deactivating 199
 - deactivating 199
- Log and diagnosis function 219

- M**
- Max. number of requests to speak
 - setting 196
- Max. number of speakers
 - setting 196
- Menu bar 145
- Microphone Limit 196
- Mouse pointer speed 152

- N**
- Network settings
 - adjusting on the central unit 153
 - dynamic IP addressing 153
 - for Windows 7 136
 - for Windows 8 139
 - for Windows Vista 134
 - for Windows XP 131
 - static IP addressing 153

- O**
- Open access mode 165
- Open Active Conference Document 156
- Operating mode
 - “Live” 149, 203
 - “Setup” 148, 189
 - buttons 147
- Override 195
- Overview 144
 - Delegate View button 146
 - menu bar 145
 - Room View button 146
 - software 144
 - toolbar 146

- P**
- Participant list 174
 - creating 185
 - exporting 188
 - importing 188
- Password
 - changing 153
 - using 152
- PC
 - system requirements 127

Premonition Time Limit **197**
Processing of the conference units’ audio signals
adjusting **201**
Push To Talk **195**

R

Radio settings, *see* Wireless conferencing
Reaction on Talktime Exceed **198**
Request **195**
Request Limit **196**
RF Status **209**
Room View window **146, 204**
Running the software
on a separate Windows PC **125, 127**
on the central unit **125, 126**

S

“Setup” operating mode **125, 172, 195**
adjusting the conference settings **195**
initializing conference units **189**
mapping a room **172**
planning and simulating conferences **125**
preparing a conference **172**
Saving **157**
Screen
adjusting the resolution **151**
does not show anything **154**
resetting the resolution **154**
Setting the display of the individual speaking time **198**
Setting the function of the “All Micros OFF” button **198**
Show talk time value **198**
Speaking time limit
activating/deactivating **197**
setting **197**
Starting
the central unit’s integrated software **143**
the Windows version of the software **143**
Status messages **206**
System requirements **127**

T

Talk Time Limit **197**
Time
adjusting **152**
Toolbar **146**
Troubleshooting **236**

U

Uninstalling the software **130**

V

View windows
adjusting **150**
adjusting the column width **150**
buttons **146**
hiding columns **150**
Voice echo, *see* Avoiding echoes

Volume
floor channel **200**
setting **201**

W

Warning messages **206**
Warning triangle **206**
Windows network settings **131**
Wireless conference unit
adding **168**
automatic log-in **166**
logging in **165**
manual log-in **167**
manual switch-off **171**
monitoring **208**
switching off all **154**
Wireless conferencing **160**
Access Mode **165**
Battery Status **209**
Country Selection **160**
country-specific settings **160**
DFS channels **163**
monitoring wireless conference units **208**
overview of RF activity **163**
RF Status **209**
setting the RF channel **161**
usable RF channels **163**

X

XLR Mix Minus **201**



Sennheiser electronic GmbH & Co. KG

Am Labor 1, 30900 Wedemark, Germany
www.sennheiser.com

Publ. 10/20, 549151/A05