

Digital 9000

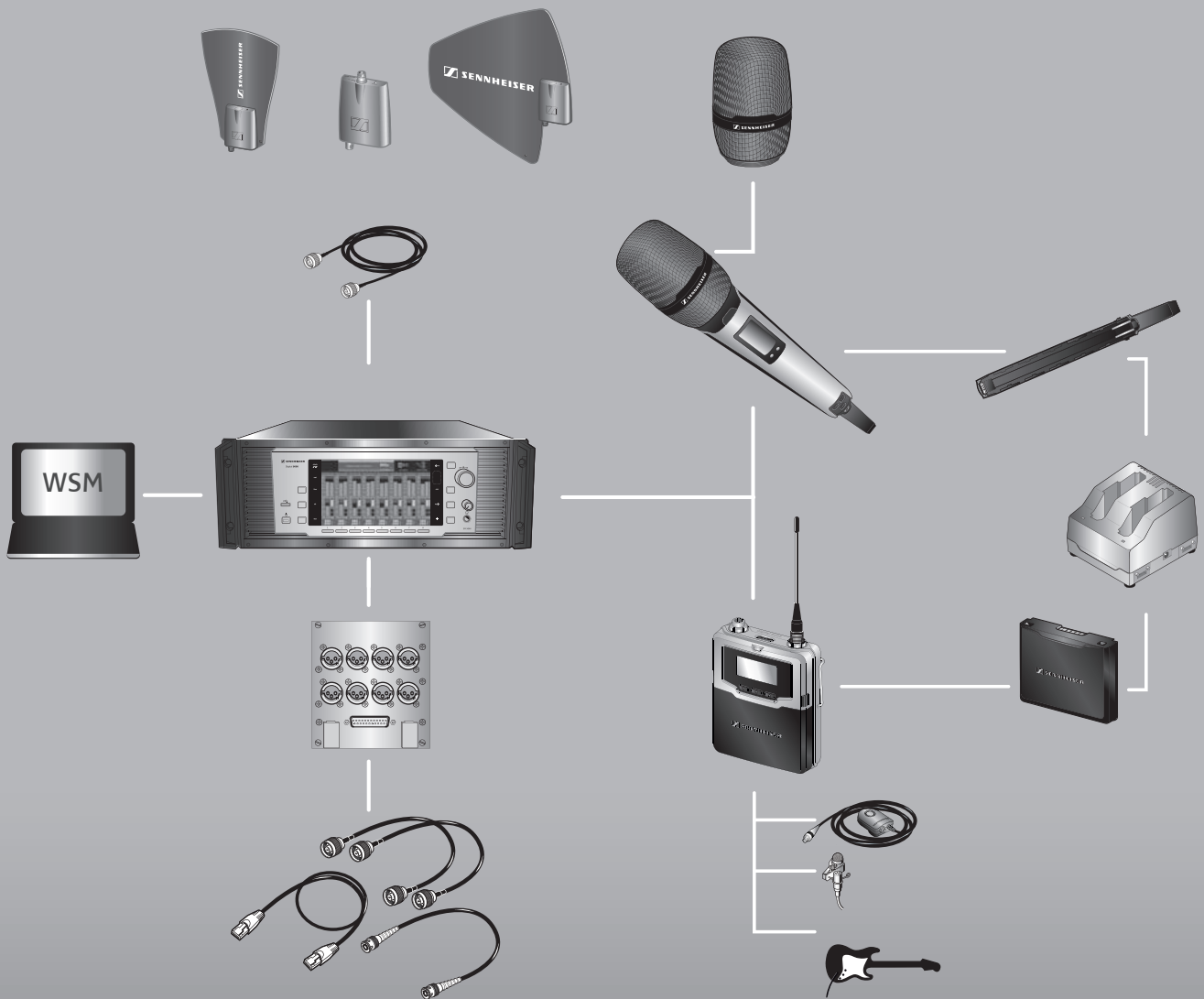

Digital 9000
System instruction manual

Content

| | |
|--|-----------|
| Important safety instructions | 6 |
| Digital 9000 – System overview | 11 |
| EM 9046 receiver | 12 |
| Antennas and antenna boosters | 12 |
| SKM 9000 radio microphone/ SK 9000 bodypack transmitter | 13 |
| L 60 charger | 13 |
| Delivery includes | 14 |
| EM 9046 receiver | 14 |
| EM 9046 CAB cable set | 14 |
| Antennas and antenna boosters | 14 |
| GZL 9000 antenna cables | 14 |
| SKM 9000/SKM 9000 COM radio microphone | 15 |
| Microphone heads for the SKM 9000 radio microphone | 15 |
| SK 9000 bodypack transmitter | 15 |
| Microphones for the SK 9000 bodypack transmitter | 15 |
| KA 9000 COM command adapter for the SK 9000 bodypack transmitter | 15 |
| CI 1-4 line/instrument cable for the SK 9000 bodypack transmitter | 15 |
| B 60/B 61 battery packs | 16 |
| BA 60/BA 61 accupack | 16 |
| L 60 charger | 16 |
| Product overview | 17 |
| EM 9046 receiver | 17 |
| Antennas and antenna boosters | 21 |
| GZL 9000 antenna cable | 22 |
| SKM 9000/SKM 9000 COM radio microphone | 22 |
| SK 9000 bodypack transmitter | 24 |
| KA 9000 COM command adapter for the SK 9000 bodypack transmitter | 26 |
| BA 60 accupack | 26 |
| BA 61 accupack | 27 |
| B 60 battery pack | 27 |
| B 61 battery pack | 28 |
| L 60 charger | 29 |
| Preparing the Digital 9000 system for use | 31 |
| Preparing the EM 9046 receiver for use | 32 |
| Setting up the receiver or mounting it into a 19" rack | 32 |
| Connecting devices to the analog audio outputs | 33 |
| Connecting devices to the digital audio outputs | 34 |
| Daisy chaining receivers | 35 |
| Connecting external word clock signals | 36 |
| Connecting receivers in a network | 36 |
| Connecting the receiver to the mains | 38 |
| Connecting headphones | 38 |
| Preparing the A/AB/AD 9000 antennas and/or antenna boosters for use | 39 |

| | |
|---|------------|
| Positioning the receiving antennas | 39 |
| Connecting the receiving antennas/antenna boosters | 40 |
| Adjusting the receiving antennas/antenna boosters | 40 |
| Preparing the SKM 9000 radio microphone for use | 40 |
| Changing the microphone head | 42 |
| Preparing the SK 9000 bodypack transmitter for use | 42 |
| Connecting the antenna | 45 |
| Connecting the KA 9000 COM command adapter | 45 |
| Preparing the L 60 charger for use | 46 |
| Cascading several chargers | 46 |
| Setting up or mounting the charger | 46 |
| Using the EM 9046 | 49 |
| Using the EM 9046 receiver | 50 |
| Switching the receiver on/off | 50 |
| “sys”, “ch”, “live” – operating modes at a glance | 51 |
| Basic functions of the Sennheiser operating menu | 51 |
| Displays of the Sennheiser operating menu | 52 |
| Error and warning messages | 54 |
| “sys” operating mode – Configuring the system | 55 |
| Overview of the “sys” menu | 55 |
| Main menu “System setup” | 56 |
| Extended menu “Service setup” | 67 |
| “ch” operating mode – Configuring channels | 76 |
| Overview of the “ch” menu | 76 |
| Main menu “Channel setup” | 77 |
| Extended menu “Transmitter setup” | 81 |
| “live” operating mode – Using a configured system | 84 |
| Using the SKM 9000 | 85 |
| Switching the SKM 9000 on/off | 86 |
| Activating/deactivating the automatic lock mode (Autolock) | 87 |
| Basic functions of the Sennheiser operating menu | 88 |
| Overview of the status displays | 88 |
| Overview of the menu items | 89 |
| Using the SK 9000 | 93 |
| Switching the SK 9000 on/off | 94 |
| Activating/deactivating the automatic lock mode (Autolock) | 95 |
| Basic functions of the Sennheiser operating menu | 96 |
| Overview of the status displays | 97 |
| Overview of the menu items | 97 |
| Using the L 60 | 101 |
| Cleaning and maintaining the Digital 9000 system | 105 |
| If a problem occurs | 109 |
| EM 9046 receiver | 110 |

| | |
|------------------------------------|------------|
| SKM 9000 radio microphone | 111 |
| SK 9000 bodypack transmitter | 111 |
| L 60 charger | 112 |
| Specifications | 113 |

Digital 9000

Important safety instructions

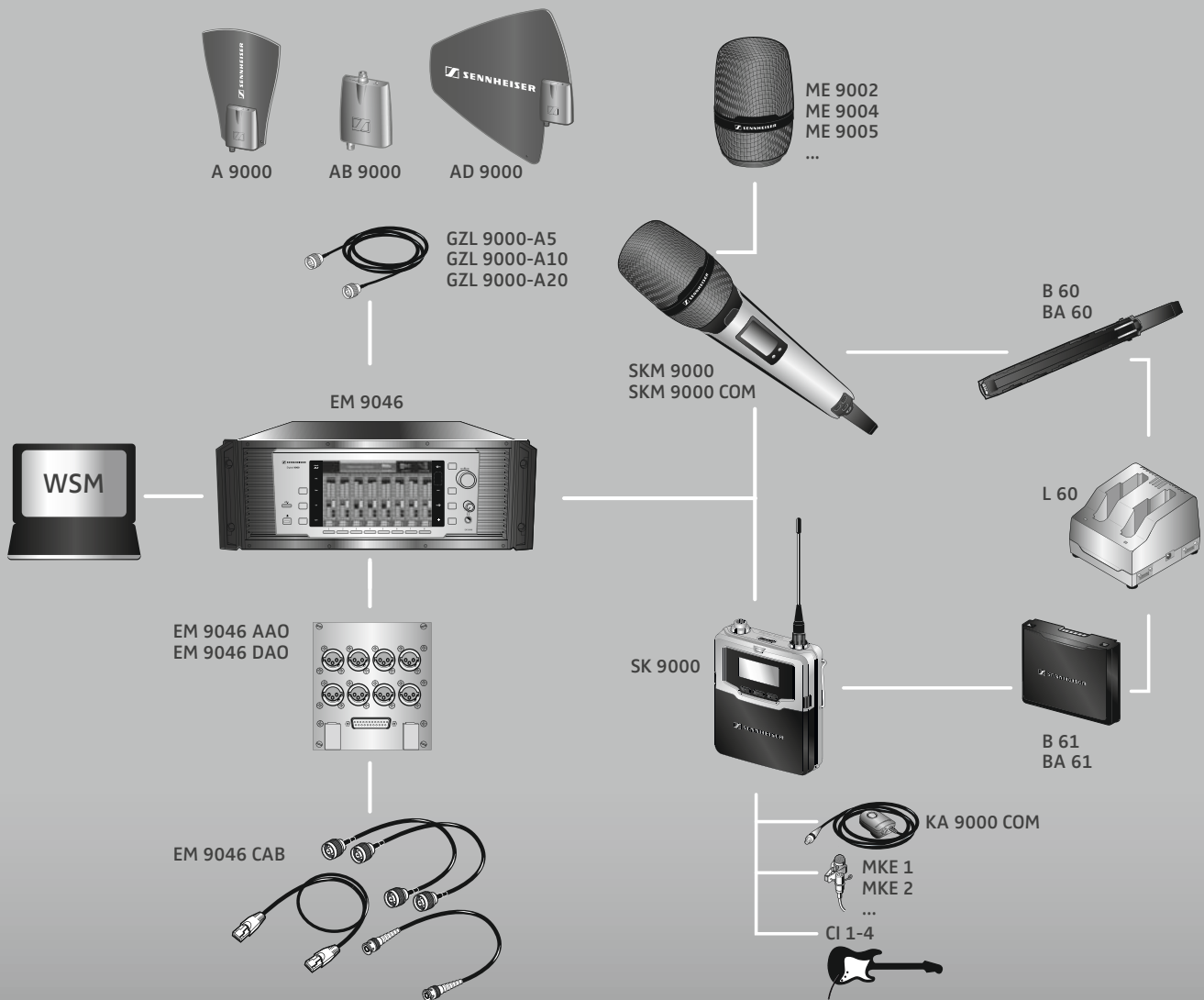

Important safety instructions

1. Read these instructions.
2. Keep these instructions. Always include these instructions when passing the apparatus on to third parties.
3. Heed all warnings.
4. Follow all instructions.
5. Do not use this apparatus near water.
6. Clean only with a dry cloth.
7. Do not block any ventilation openings. Install in accordance with the manufacturer's instructions.
8. Do not install near any heat sources such as radiators, heat registers, stoves, or other apparatus (including amplifiers) that produce heat.
9. Do not defeat the safety purpose of the polarized or grounding-type plug. A polarized plug has two blades with one wider than the other. A grounding type plug has two blades and a third grounding prong. The wide blade or the third prong are provided for your safety. If the provided plug does not fit into your outlet, consult an electrician for replacement of the obsolete outlet.
10. Protect the power supply cord from being walked on or pinched, particularly at plugs, convenience receptacles, and the point where it exits from the apparatus.
11. Only use attachments, accessories and spare parts specified by the manufacturer.
12. Use only with the cart, stand, tripod, bracket, or table specified by the manufacturer, or sold with the apparatus.
When a cart is used, use caution when moving the cart/apparatus combination to avoid injury from tip-over.
13. Unplug this apparatus during lightning storms or when unused for long periods of time.
14. Refer all servicing to qualified service personnel.
Servicing is required when the apparatus has been damaged in any way, such as power supply cord or plug is damaged, liquid has been spilled or objects have fallen into the apparatus, when the apparatus has been exposed to rain or moisture, does not operate normally, or has been dropped.
15. To completely disconnect this apparatus from the AC mains, disconnect the power supply cord plug from the AC receptacle.
16. **WARNING:** To reduce the risk of fire or electric shock, do not expose this apparatus to rain or moisture.
17. Do not expose this equipment to dripping or splashing and ensure that no objects filled with liquids, such as vases, are placed on the equipment.
18. The mains plug of the power supply cord shall remain readily accessible.





Hazard warnings on the rear of the receiver

The label shown on the left is attached to the rear of the EM 9046.

The symbols on this label have the following meaning:

Presence of uninsulated dangerous voltage within the EM 9046's enclosure that may be of sufficient magnitude to constitute a risk of electric shock.

Never open the EM 9046 as there is a risk of electric shock. There are no user serviceable parts inside. Never attempt to change the modules of the EM 9046 yourself. Always refer repairs, servicing and the change of the modules to your authorized Sennheiser service partner.

Read and follow the safety and operating instructions contained in the instruction manual.

Risk of fire due to overloading

Do not overload wall outlets and extension cables as this may result in fire and electric shock.

Danger of hearing damage due to high volumes

This is a professional receiver. Commercial use is subject to the rules and regulations of the trade association responsible. Sennheiser, as the manufacturer, is therefore obliged to expressly point out possible health risks arising from use.

This receiver is capable of producing sound pressure levels exceeding 85 dB(A). 85 dB(A) is the sound pressure corresponding to the maximum permissible volume which is by law (in some countries) allowed to affect your hearing for the duration of a working day. It is used as a basis according to the specifications of industrial medicine. Higher volumes or longer durations can damage your hearing. At higher volumes, the duration must be shortened in order to prevent hearing damage. The following are sure signs that you have been subjected to excessive noise for too long a time:

- You can hear ringing or whistling sounds in your ears.
- You have the impression (even for a short time only) that you can no longer hear high notes.

Intended use

Intended use of the Digital 9000 system components includes:

- having read and understood this instruction manual, especially the chapter "Important safety instructions",
- using the products within the operating conditions and limitations described in this instruction manual.

"Improper use" means using the products other than as described in these instructions, or under operating conditions which differ from those described herein.



This instruction manual is also available at www.sennheiser.com.

Safety instructions for A/AB/AD 9000 antennas/antenna boosters

Use safety wires to protect the receiving antennas against tipping/dropping. The safety wires, rope terminations and coupling links must comply in their dimensioning and condition with the regulations and standards of the country in which they are used!

Safety instructions for lithium-ion rechargeable batteries





If abused or misused, the rechargeable batteries of the SK 9000/SKM 9000 may leak. In extreme cases, they may even present a risk of



- explosion,
- fire development,
- heat generation,
- smoke or gas development.

Sennheiser does not accept any liability for damage arising from abuse or misuse.

| | | | |
|--|--|--|---|
| | Keep away from children. | | Only charge rechargeable batteries with a charger recommended by Sennheiser. |
| | Observe correct polarity. | | Pack/store charged rechargeable batteries so that the terminals cannot contact each other – danger of shorting out/fire hazard. |
| | Do not expose to moisture. | | Switch rechargeable battery-powered products off after use. |
| | Only charge rechargeable batteries at ambient temperatures between 10 °C/50 °F and 40 °C/104 °F. | | When not using rechargeable batteries for extended periods of time, charge them regularly (about every three months). |
| | Do not mutilate or dismantle. | | Do not heat above 60 °C/140 °F, e.g. do not expose to sunlight or throw into a fire. |
| | Immediately remove rechargeable batteries from an obviously defective product. | | Do not continue to use defective rechargeable batteries. |

| | | | |
|---|---|---|--|
|  | Only use rechargeable batteries specified by Sennheiser. |  | Dispose of rechargeable batteries at special collection points or return them to your specialist dealer. |
|  | Store the product in a cool and dry place at room temperature (approx. 20 °C/ 68 °F). |  | Remove the rechargeable batteries if the product will not be used for extended periods of time. |

Digital 9000 System overview

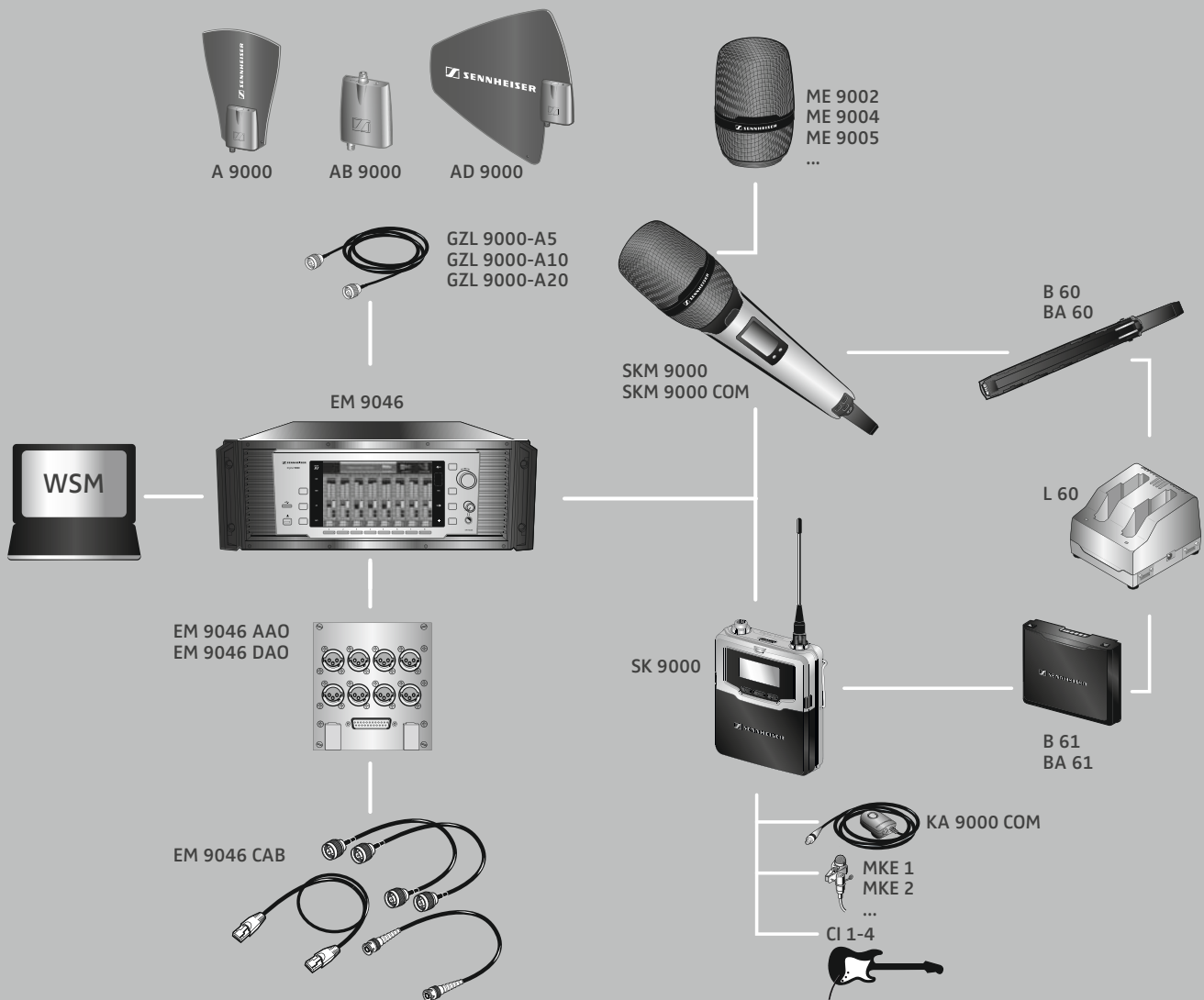

| | | | |
|--|-----------|--|-----------|
| Digital 9000 – System overview | 11 | CI 1-4 line/instrument cable for the | |
| EM 9046 receiver | 12 | SK 9000 bodypack transmitter | 15 |
| Antennas and antenna boosters | 12 | B 60/B 61 battery packs | 16 |
| SKM 9000 radio microphone/ | | BA 60/BA 61 accupack | 16 |
| SK 9000 bodypack transmitter | 13 | L 60 charger | 16 |
| L 60 charger | 13 | Product overview | 17 |
| Delivery includes | 14 | EM 9046 receiver | 17 |
| EM 9046 receiver | 14 | Antennas and antenna boosters | 21 |
| EM 9046 CAB cable set | 14 | GZL 9000 antenna cable | 22 |
| Antennas and antenna boosters | 14 | SKM 9000/SKM 9000 COM radio microphone | 22 |
| GZL 9000 antenna cables | 14 | SK 9000 bodypack transmitter | 24 |
| SKM 9000/SKM 9000 COM radio microphone | 15 | KA 9000 COM command adapter for the | |
| Microphone heads for the SKM 9000 radio | | bodypack transmitter | 26 |
| microphone | 15 | BA 60 accupack | 26 |
| SK 9000 bodypack transmitter | 15 | BA 61 accupack | 27 |
| Microphones for the SK 9000 bodypack transmitter | 15 | B 60 battery pack | 27 |
| KA 9000 COM command adapter for the | | B 61 battery pack | 28 |
| SK 9000 bodypack transmitter | 15 | L 60 charger | 29 |

The Digital 9000 system

The Digital 9000 system is characterized by its high transmission reliability and easy of use. The large switching bandwidth as well as various different connection possibilities offer great flexibility in daily use.

- Outstanding sound quality due to digital transmission technology
- Efficient use of the available frequency spectrum
- Frequencies tuneable in 25 kHz steps
- Switching bandwidth across the entire UHF range (470 MHz to 798 MHz)
- Encryption of the digital audio signal
- Intuitive, icon-based operating menu
- Modular system
- Infra-red synchronization of receivers and transmitters
- WSM-assisted

EM 9046 receiver

- Scan function
- True bit diversity technology
- Audio output level adjustable in 1 dB steps
- Configurable Command audio output
- EM 9046 receiver can be equipped with up to 8 EM 9046 DRX receiver modules for 8 individually adjustable channels
- Optional audio modules: transformer balanced analog or digital (AES3)
- Up to 4 receivers can be RF daisy chained
- Up to 8 receivers can be connected in a network
- High quality antenna splitters with booster supply
- Internal and external word clock synchronization of digital audio outputs
- Ethernet socket for connection to a PC and/or for connection of several receivers in a network
- Headphone output with high gain reserve

Antennas and antenna boosters

- A 9000 active, intelligent, omni-directional antenna
- AD 9000 active, intelligent, directional antenna
- AB 9000 active, intelligent antenna booster
- Power supply via EM 9046
- EM 9046-controlled preselection of booster frequency ranges "A1" ... "A8" or "B1" ... "B8" (24 MHz respectively)
- Automatic calibration of cable attenuation
- Can also be used with other receivers with booster supply voltage (e.g. EM 3732-II)

SKM 9000 radio microphone/ SK 9000 bodypack transmitter

The SKM 9000 and SK 9000 transmitters offer great ease of use and can easily be adapted to any transmission situation:

- Rugged housing
- Input gain adjustable in 3 dB steps
- Switchable 1 kHz test tone, useful for level matching the system and for the walk test
- High accuracy of charge status display (B/BA 60/61) or remaining operating time display (B 60/61)
- Detection and support of the type of microphone head being used, incl. Neumann microphone heads
- Switchable low cut filter for filtering out low frequency components
- Frequencies tuneable in 25 kHz steps

SKM 9000 radio microphone

- Power supply optionally via BA 60 lithium-ion accupack or B 60 battery pack (2 AA size alkaline batteries or 2 AA size lithium batteries)
- Different microphone heads for different areas of application (see page 23)
- Optionally available with command function (SKM 9000 COM)

SK 9000 bodypack transmitter

- Power supply optionally via BA 61 lithium-ion accupack or B 61 battery pack (3 AA size alkaline batteries or 3 AA size lithium batteries)
- Automatic detection of the input signal type (mic, line, instrument) when Sennheiser accessories are used
- Emulation of different instrument cable lengths
- Different clip-on microphones for different areas of application (see page 25)
- Command function via KA 9000 COM command adapter

L 60 charger

- Simultaneous charging of up to two BA 60/BA 61 accupacks
- Up to four chargers can be cascaded together

Delivery includes

You can make up your own Digital 9000 system with the following components:

EM 9046 receiver

- 1 EM 9046 receiver
 - fixedly** equipped with
 - PSU power supply unit
 - CCC core clock controller
 - ASP antenna splitter
 - AUX blanking plate
 - optionally** equipped with
 - up to eight EM 9046 DRX receiver modules and
 - AAO/DAO analog/digital audio out modules
- 3 mains cables (with EU, UK and US plug)
- 1 CAT 5 Ethernet cable
- 1 instruction manual
- 1 CD ROM with
 - "Wireless Systems Manager" (WSM) software
 - WSM instruction manual
- 1 CD ROM with instruction manual for the Digital 9000 system



The optional EM 9046 DRX, AAO and DAO modules can be purchased from and must be assembled by your Sennheiser service partner.

EM 9046 CAB cable set

- 2 RF patch cable (type N, 50 Ω)
- 1 Ethernet patch cable (RJ45 connectors, CAT 5)
- 1 Word clock patch cable (BNC, 75 Ω)

Antennas and antenna boosters

- 1 A 9000 omni-directional antenna **or**
- 1 AD 9000 directional antenna **or**
- 1 AB 9000 antenna booster
- 1 supplement

GZL 9000 antenna cables

- 1 GZL 9000-A5 antenna cable (length 5 m) **or**
- 1 GZL 9000-A10 antenna cable (length 10 m) **or**
- 1 GZL 9000-A20 antenna cable (length 20 m)

SKM 9000/SKM 9000 COM radio microphone

- 1 SKM 9000 radio microphone [or](#)
- 1 SKM 9000 COM radio microphone
- 1 MZQ 9000 microphone clamp
- 1 supplement "Framework requirements and restrictions on frequency usage in Europe"
- 1 instruction manual



You additionally require microphone heads as well as a BA 60 accu-pack and/or a B 60 battery pack. If you are using the BA 60 accu-pack, you will also require an L 60 charger.

Microphone heads for the SKM 9000 radio microphone

- 1 microphone head
- 1 MZQ 9000 microphone clamp
- 1 instruction manual



For an overview of all microphone heads for the SKM 9000 radio microphone, refer to page 23.

SK 9000 bodypack transmitter

- 1 SK 9000 bodypack transmitter
- 1 supplement "Framework requirements and restrictions on frequency usage in Europe"
- 1 instruction manual



You additionally require microphones or the CI 1-4 line/instrument cable as well as a BA 61 accupack and/or a B 61 battery pack. If you are using the BA 61 accupack, you will also require an L 60 charger

Microphones for the SK 9000 bodypack transmitter

- 1 microphone
- 1 instruction manual



For an overview of all microphones for the SK 9000 bodypack transmitter, refer to page 25.

KA 9000 COM command adapter for the SK 9000 bodypack transmitter

- 1 command adapter
- 1 instruction manual

CI 1-4 line/instrument cable for the SK 9000 bodypack transmitter

- 1 CI 1-4 line/instrument cable
- 1 instruction manual

B 60/B 61 battery packs

- 1 B 60 battery pack for SKM 9000 radio microphone [or](#)
- 1 B 61 battery pack for SK 9000 bodypack transmitter
- 1 instruction manual

BA 60/BA 61 accupack

- 1 BA 60 accupack for SKM 9000 radio microphone [or](#)
- 1 BA 61 accupack for SK 9000 bodypack transmitter
- 1 instruction manual

L 60 charger

- 1 L 60 charger for BA 60/BA 61 accupacks
- 1 instruction manual



For powering the L 60 charger, you require the NT 3-1 mains unit with a country-specific mains cable (EU, UK or US version).

One NT 3-1 mains unit can power up to four chargers.



A list of accessories can be found on the Digital 9000 product page at www.sennheiser.com. For information on suppliers, contact your local Sennheiser partner: www.sennheiser.com >“Service & Support”.

Product overview

EM 9046 receiver

Overview of the front panel

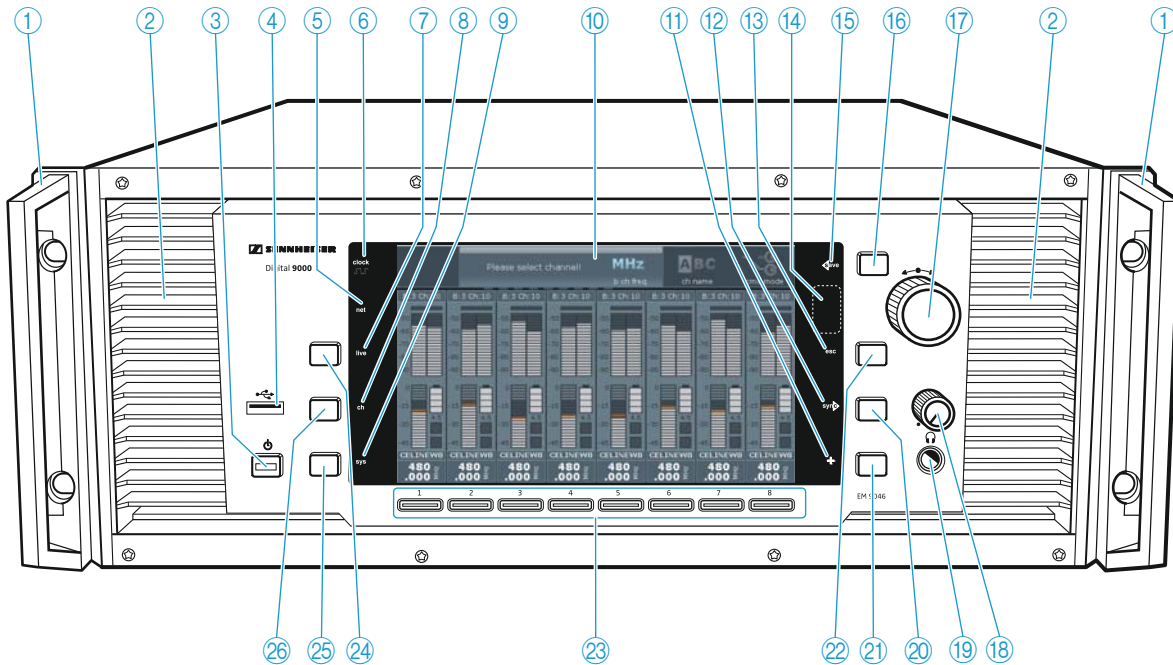

- ① Rack-mount "ear" with handle
- ② Ventilation openings
- ③ Standby button
- ④ USB socket
- ⑤ net LED (network)
- ⑥ clock LED (external word clock synchronization)
- ⑦ live LED
- ⑧ ch LED
- ⑨ sys LED
- ⑩ Display panel
- ⑪ + LED
- ⑫ syn LED
- ⑬ esc LED
- ⑭ Infra-red interface
- ⑮ save LED
- ⑯ save button
- ⑰ Jog dial for menu control
- ⑱ Headphone volume control
- ⑲ Headphone socket, 1/4" (6.3 mm) jack socket
- ⑳ syn button
- ㉑ Multiple channel selection button +
- ㉒ esc button
- ㉓ Channel 1 to 8 button
- ㉔ live button (for selecting the "live" operating mode)
- ㉕ sys button (for configuring the system)
- ㉖ ch button (for configuring the channels)

Overview of the rear panel

The overview of the rear panel shows an EM 9046 receiver equipped with the fixed PSU, CCC and ASP modules and the optional DRX, DAO and AAO modules. The configuration shown is an example configuration. The interchangeable modules are highlighted in color.

Your Sennheiser service partner can configure the EM 9046 as follows:

- 1 to 8 EM 9046 DRX receiver modules H
- 1 AAO analog audio out module D and 1 DAO digital audio out module E or
- 2 AAO analog audio out modules D or
- 2 DAO digital audio out modules E

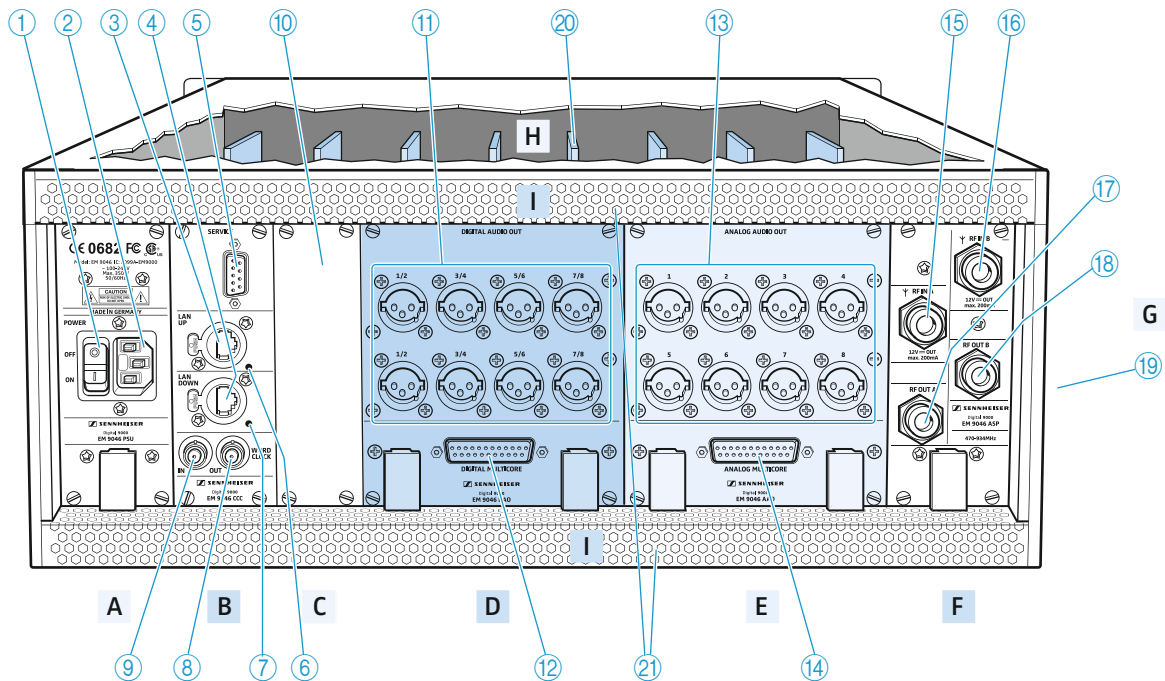

A | PSU – power supply unit

- ① ON/OFF switch
 - ② IEC mains socket, 3-pin
- ### B | CCC – clock core controller
- ③ LAN UP socket
 - ④ LAN DOWN socket
 - ⑤ SERVICE interface
 - ⑥ LAN UP LED
 - ⑦ LAN DOWN LED
 - ⑧ WORD CLOCK OUT socket (BNC), looped-through output (75 Ω)
 - ⑨ WORD CLOCK IN socket (BNC), input (75 Ω)

C | Aux opening for optional extensions

- ⑩ Blanking plate for aux opening

D | DAO – digital audio out

- ⑪ XLR-3 sockets (male) for digital audio outputs 1/2 to 7/8, balanced, AES3
- ⑫ DIGITAL MULTICORE socket (sub-D, 25-pin), digital, balanced

E | AAO – analog audio out

- ⑬ XLR-3 sockets (male) for analog audio outputs 1 to 8, transformer balanced
- ⑭ ANALOG MULTICORE socket (sub-D, 25-pin), analog, transformer balanced

F | ASP – antenna splitter

- ⑮ RF IN A socket (N-type), antenna input, 12 V $\overline{=}$ out, max. 200 mA, 50 Ω
- ⑯ RF IN B socket (N-type), antenna input, 12 V $\overline{=}$ out, max. 200 mA, 50 Ω
- ⑰ RF OUT A socket (N-type), daisy chain output
- ⑱ RF OUT B socket (N-type), daisy chain output

G | Type plate

- ⑲ EM 9046 type plate

H | DRX – receiver modules

- ⑳ DRX receiver modules 1 ... 8

I | Ventilation openings

- ㉑ Ventilation openings

i For the pin assignment of the XLR-3 and sub-D sockets of the EM 9046, refer to the chapter “Specifications” on page 123.

Overview of the displays and the clock LED

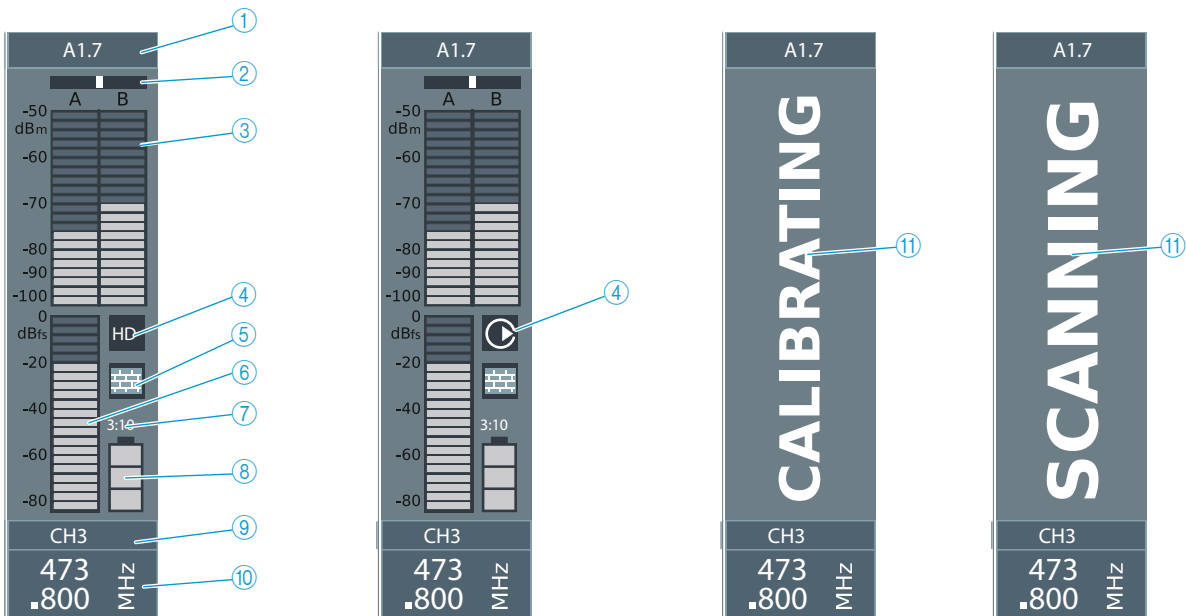

① Frequency preset display

A1.7

- A** Selected booster (type A or type B)
- 1** Selected booster frequency range (1 ... 8)
(bandwidth: 24 MHz)
- 7** Frequency preset (1 ... 40)

In addition, channel-related warnings are displayed in alternation with the frequency preset display:



| | |
|------------|---|
| range | The frequency range set is outside the booster frequency range |
| low bat. | Charge status of accupack/battery pack is critical |
| no signal | No evaluable RF signal |
| peak | Audio signal is overmodulated |
| booster | No booster connected to one or both RF IN A/B N-type sockets |
| sync fail | Infra-red synchronization has failed |
| encryption | Audio signal of this channel is bound to the EM 9046 |

- ② Diversity evaluation display (true bit diversity)
- ③ Antenna signal display (dBm)
- ④ “HD”/“LR” and “Command” display
- ⑤ “Encryption” display
- ⑥ Audio level display (dBfs)
- ⑦ Display for remaining operating time of the transmitter

- ⑧ Display for charge status of accupack/battery pack
- ⑨ Channel name display
- ⑩ Receiving channel display
- ⑪ Channel status displays (examples)

The clock LED ⑥

The clock LED  ⑥ provides information on the following states:

| clock LED  | Meaning |
|---|--|
| lights up | The receiver's digital audio output is synchronized with an external word clock signal. |
| flashes | The "Word clock" menu item is set to "external", but the EM 9046 receiver cannot find an external word clock signal and generates its own word clock signal. The word clock rate of this signal corresponds to the last set or active word clock rate. As soon as an external word clock signal is present at the WORD CLOCK IN BNC socket ⑨, the digital audio output of the EM 9046 automatically synchronizes with it and the clock LED  ⑥ lights up constantly. |
| if off | The EM 9046 receiver generates its own word clock signal. |

Antennas and antenna boosters

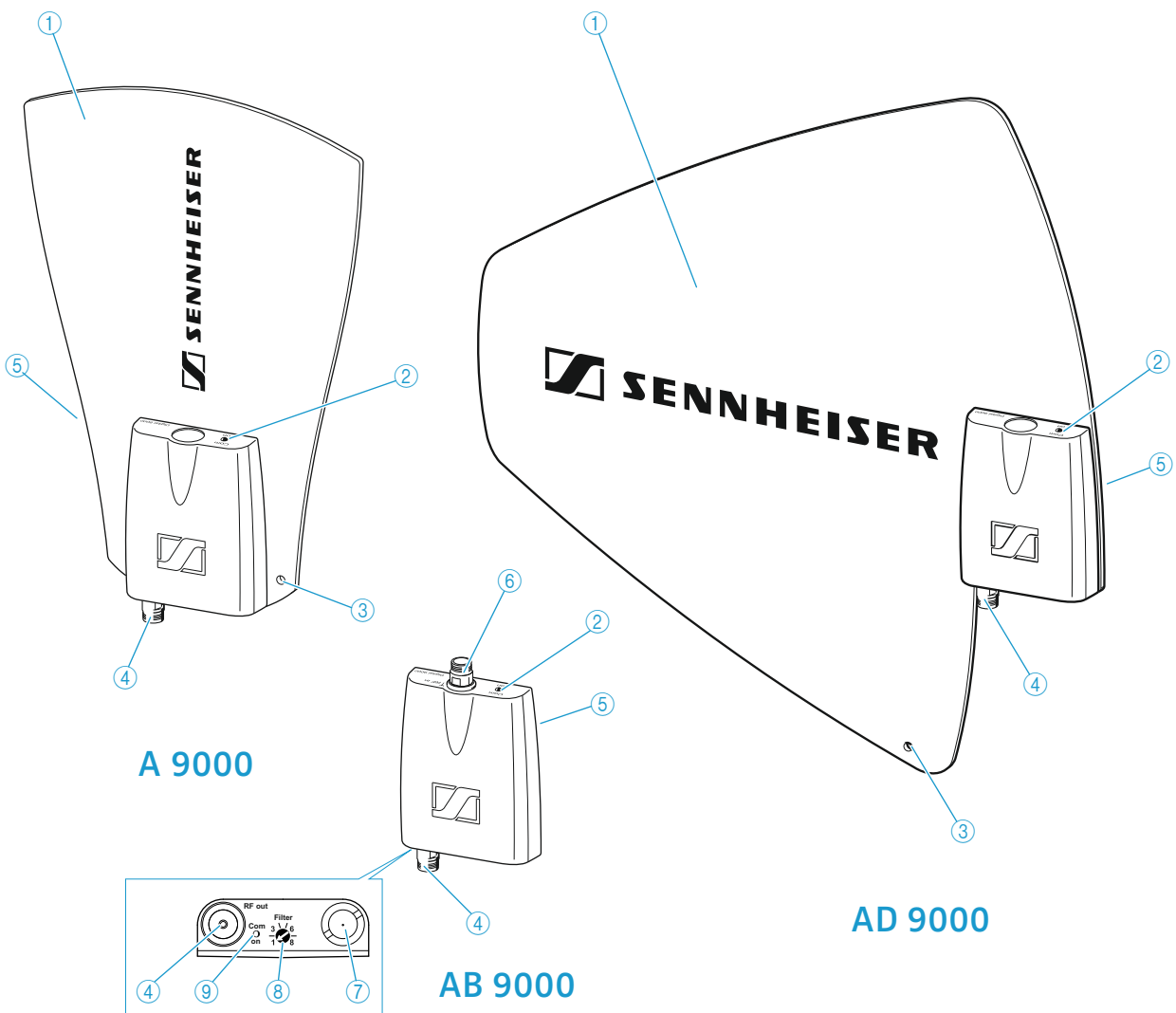

- ① Antenna surface
- ② and ⑨: "Com" and "On" LED
 - red: error
 - green: manual mode
 - blue: automatic mode (EM 9046-controlled)
 - white: firmware update in progress
- ③ Hole for connection of safety wires
- ④ RF out socket (N-type)
- ⑤ Type plate (not visible here)
- ⑥ RF in socket (N-type) (AB 9000 only)
- ⑦ Stand adapter
- ⑧ "Filter" rotary switch (see below)

i If you are using the antennas/antenna booster with the EM 9046, the "Filter" rotary switch has no function because the frequency range is automatically set. If you are **not** using the antennas/antenna booster with the EM 9046, the "Filter" rotary switch allows you to set the desired frequency range ("A1" ... "A8" or "B1" ... "B8").

GZL 9000 antenna cable

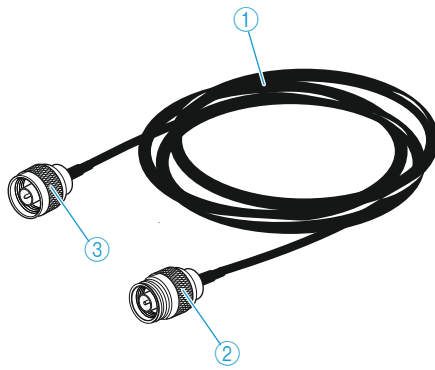

- ① GZL cable, available in lengths of 5 m, 10 m and 20 m
- ② N-type connector
- ③ N-type socket

SKM 9000/SKM 9000 COM radio microphone

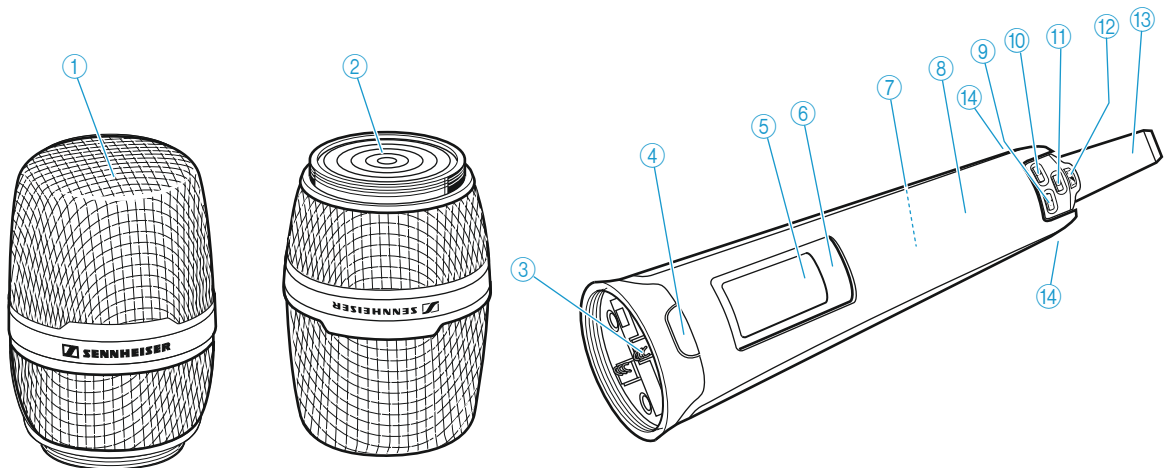

- ① Microphone head
- ② Contacts of microphone head
- ③ Contacts of radio microphone
- ④ COMMAND button* (SKM 9000 COM)
- ⑤ Display panel
- ⑥ Infra-red interface
- ⑦ Accupack or battery pack for 2 AA size cells
- ⑧ Body of radio microphone
- ⑨ DOWN button ◀
- ⑩ UP button ▶
- ⑪ SET button
- ⑫ ON/OFF button with ESC function (cancel)
- lights up constantly:
radio microphone is operational
- ⑬ Antenna
- ⑭ Catches for accupack/battery pack

* The function of the COMMAND button can be configured via the menu of the EM 9046 receiver; refer to "Cmd mode" – Configuring the audio and command outputs" in the system instructions

Overview of the standard display after switch-on

After switch-on, the radio microphone displays the currently selected standard display (here: "Frequency"). For an overview of all standard displays, refer to page 90.

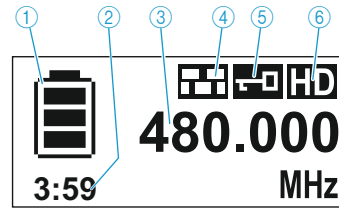

- ① Display for charge status of the accupack/battery pack
- ② Operating time display (only when used with the BA 60 accupack)
- ③ Frequency/channel/name display, switchable
- ④ "Encryption" display
- ⑤ Lock mode icon
- ⑥ Transmission mode display: "HD" (High Definition Audio) or "LR" (Long Range Audio)

Recommended microphone heads for the SKM 9000 radio microphone

| Microphone head | Pick-up pattern | Transducer principle |
|------------------|-------------------------------------|-----------------------|
| ME 9002 | omni-directional | condenser |
| ME 9004 | cardioid | condenser |
| ME 9005 | super-cardioid | condenser |
| MD 9235 | super-cardioid | dynamic |
| MMD 935-1 | cardioid | dynamic |
| MMD 945-1 | super-cardioid | dynamic |
| MMK 965-1 | cardioid/super-cardioid, switchable | permanently polarized |
| KK 204 (Neumann) | cardioid | condenser |
| KK 205 (Neumann) | super-cardioid | condenser |

i You can also use your radio microphone together with the microphone heads of the ew G3 and 2000 series.

SK 9000 bodypack transmitter

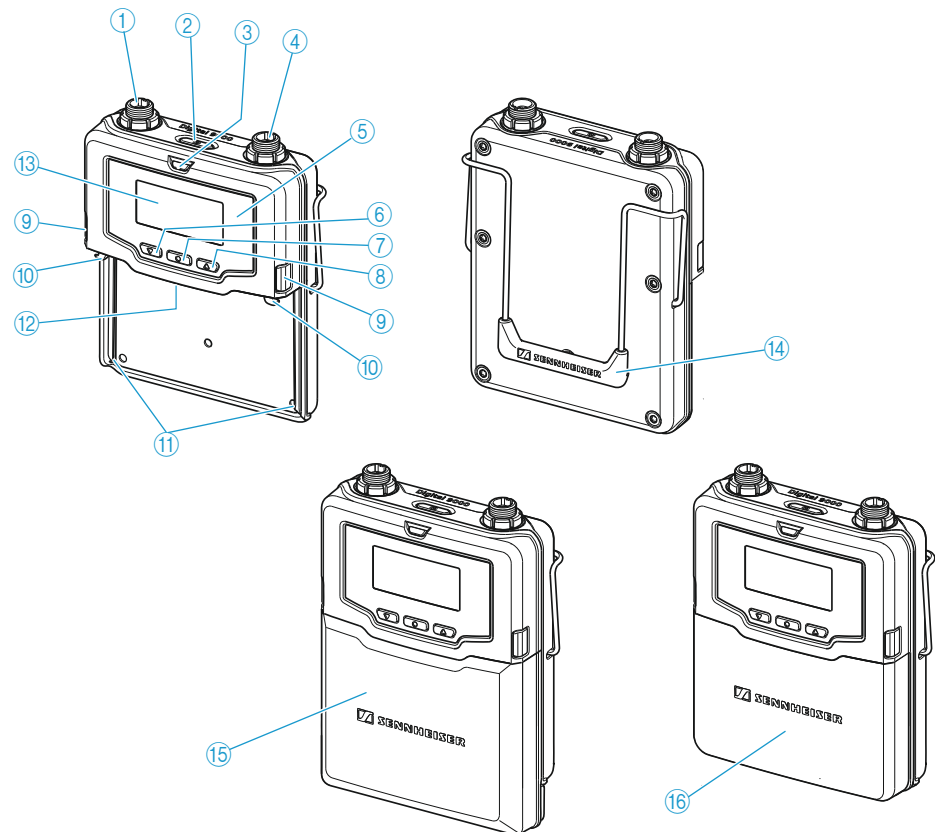

- ① 3-pin special audio socket for
 - Sennheiser microphones
 - CI 1-4 Sennheiser instrument cable
 - KA 9000 COM command adapter
- ② ON/OFF button with ESC function (cancel)
- ③ ON LED
 - lights up constantly: transmitter is operational
 - flashes regularly: remaining operating time is less than 30 minutes
 - flashes with high levels: audio signal is excessively high
- ④ Antenna socket
- ⑤ Infra-red interface
- ⑥ DOWN button
- ⑦ SET button
- ⑧ UP button
- ⑨ Catches for accupack/battery pack
- ⑩ Snap-in elements for accupack/battery pack
- ⑪ Guide rails for accupack/battery pack
- ⑫ Contacts for supply voltage and data contacts
- ⑬ Display panel
- ⑭ Belt clip
- ⑮ Battery pack for 3 AA size cells
- ⑯ Accupack

Overview of the standard display after switch-on

After switch-on, the bodypack transmitter displays the currently selected standard display (here: "Frequency"). For an overview of all standard displays, refer to page 99.

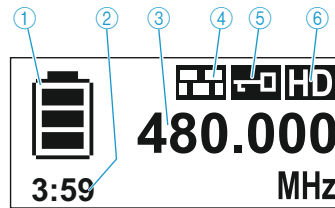

- ① Display for charge status of the accupack/battery pack
- ② Operating time display (only when used with the BA 61)
- ③ Frequency/channel/name display, switchable
- ④ "Encryption" display
- ⑤ Lock mode icon
- ⑥ Transmission mode display: "HD" (High Definition Audio) or "LR" (Long Range Audio)

Microphones for the SK 9000 bodypack transmitter

| Microphone | Pick-up pattern |
|------------|------------------|
| MKE 1 | omni-directional |
| MKE 2 | cardioid |
| ME 102 | omni-directional |
| ME 104 | cardioid |
| ME 105 | super-cardioid |
| HSP 2 | omni-directional |
| HSP 4 | cardioid |

Sennheiser CI 1-4 line/instrument cable

1/4" (6.3 mm) jack plug (silent plug) to 3-pin special audio connector

KA 9000 COM command adapter for the SK 9000 bodypack transmitter

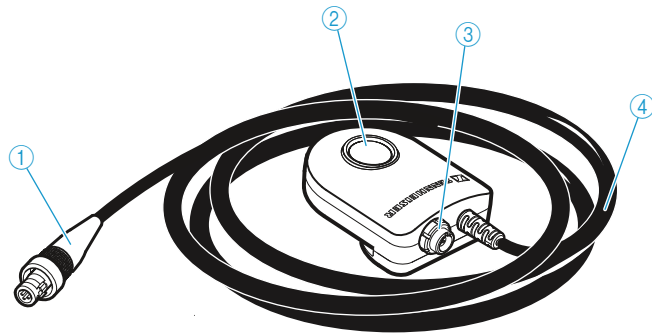

- ① 3-pin special audio connector
- ② COMMAND button
- ③ 3-pin special audio socket
- ④ Connection cable, length: 1.6 m

BA 60 accupack

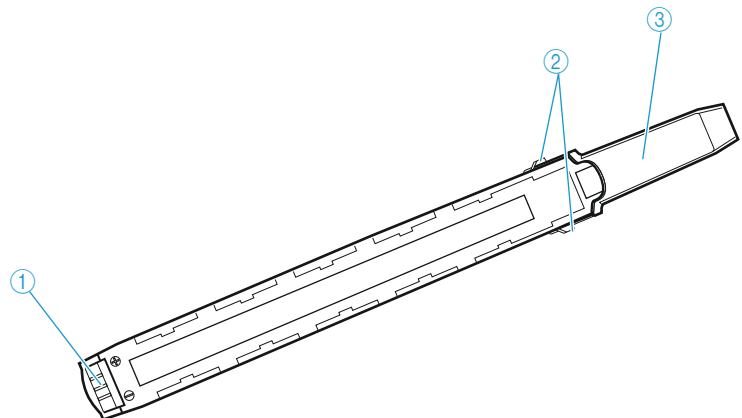

- ① Charging and data contacts
- ② Snap-in elements
- ③ Antenna

BA 61 accupack

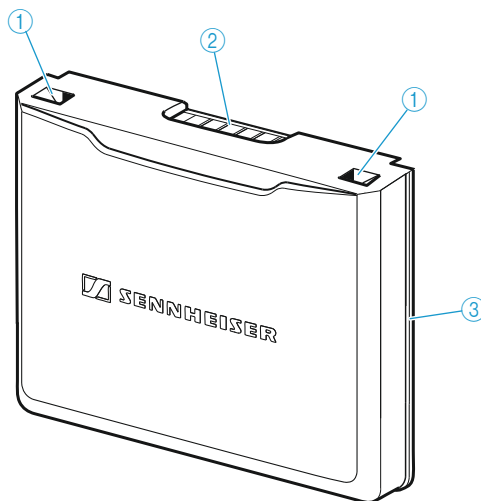

- ① Snap-in elements
- ② Charging and data contacts
- ③ Guide rail

B 60 battery pack

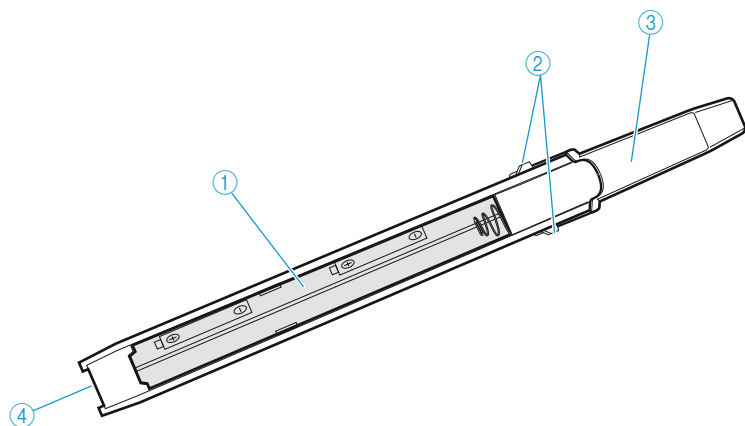

- ① Battery compartment for 2 AA size batteries
- ② Snap-in elements
- ③ Antenna
- ④ Data contacts

B 61 battery pack

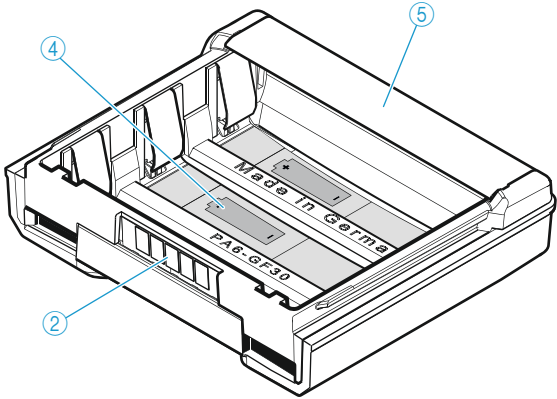
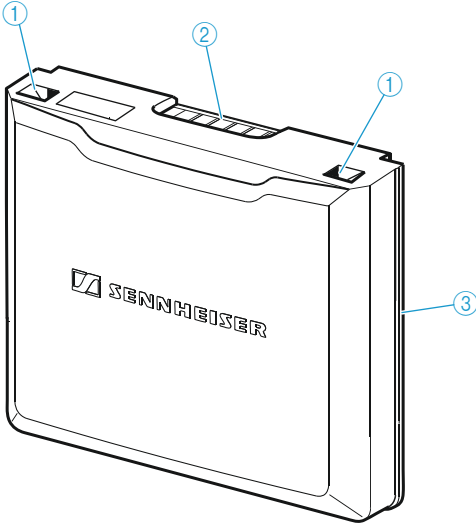

- ① Snap-in elements
- ② Data contacts
- ③ Guide rail
- ④ Battery compartment for 3 AA size batteries
- ⑤ Cover

L 60 charger

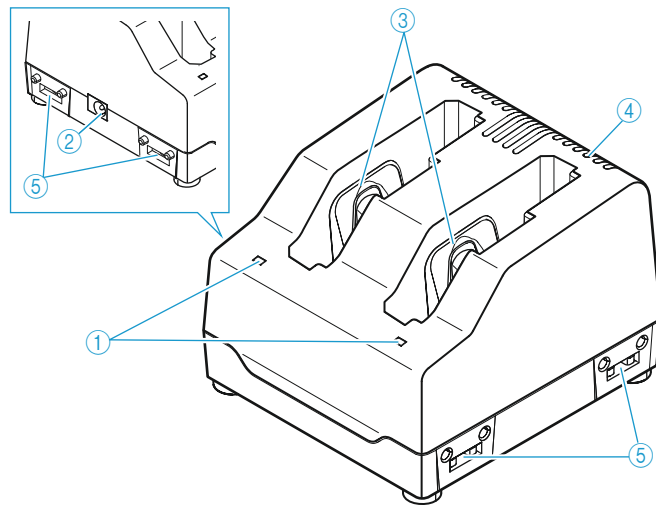

- ① Status LED
- ② DC input socket for connection of NT 3-1 mains unit
- ③ Charging compartments for BA 61 or BA 60 accupacks
- ④ Ventilation openings
- ⑤ Rails for cascading up to 4 chargers

Indications of the status LED

| Status LED ① | Meaning |
|--------------|---|
| off | Standby mode/no connection to the mains |
| red | Accupack is being charged, capacity obtained is approx. 0-70% |
| orange | Accupack is being charged, capacity obtained is approx. 70-100% |
| green | Accupack is fully charged, capacity is continuously monitored |
| flashing red | Error, charging is aborted (accupack is e.g. defective or overheated) |

Digital 9000

Preparing for use

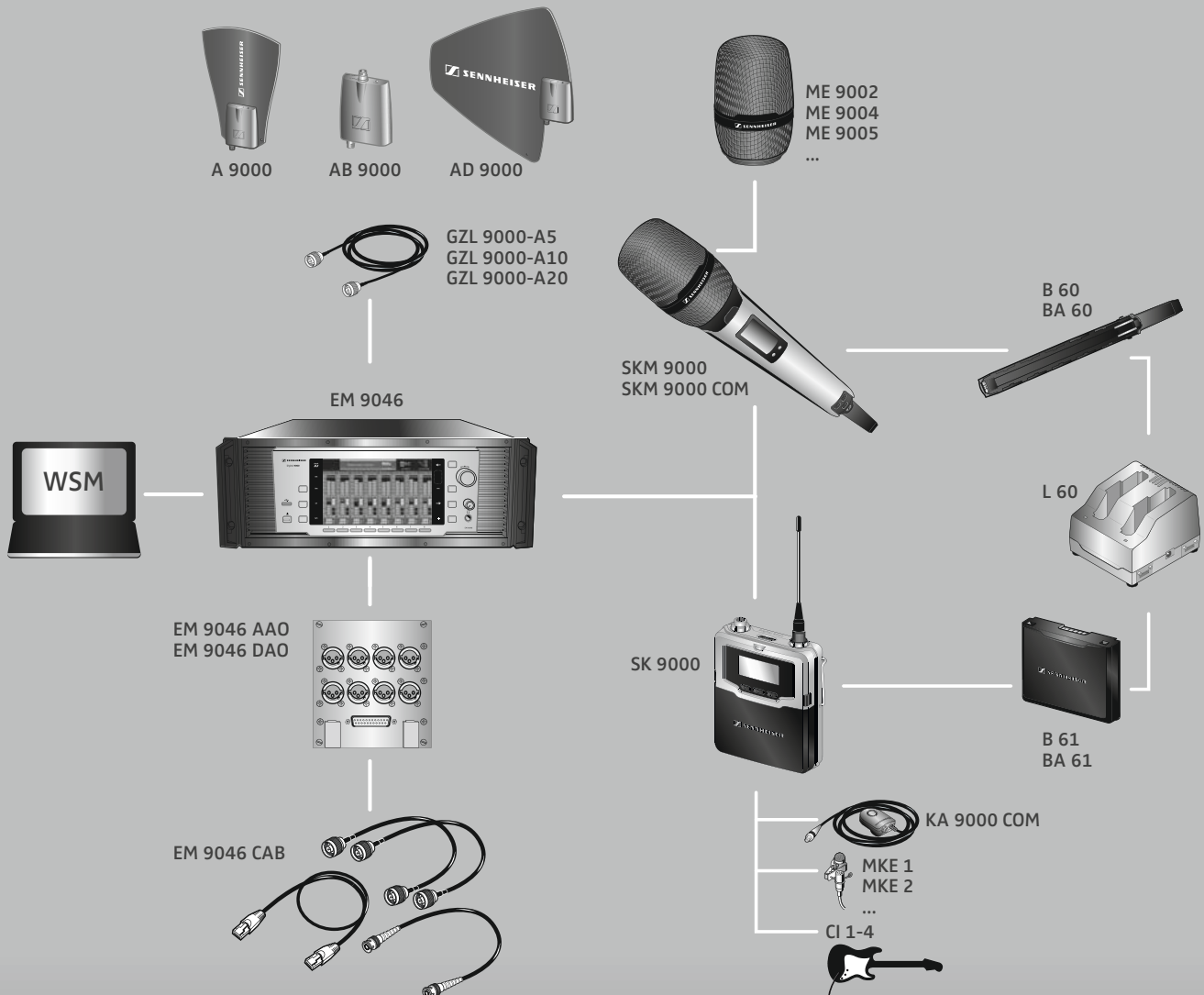

| | |
|---|-----------|
| Preparing the Digital 9000 system for use | 31 |
| Preparing the EM 9046 receiver for use | 32 |
| Setting up the receiver or mounting it into a 19" rack | 32 |
| Connecting devices to the analog audio outputs | 33 |
| Connecting devices to the digital audio outputs | 34 |
| Daisy chaining receivers | 35 |
| Connecting external word clock signals | 36 |
| Connecting receivers in a network | 36 |
| Connecting the receiver to the mains | 38 |
| Connecting headphones | 38 |
| Preparing the A/AB/AD 9000 antennas and/or antenna boosters for use | 39 |

| | |
|--|----|
| Positioning the receiving antennas | 39 |
| Connecting the receiving antennas/antenna boosters | 40 |
| Adjusting the receiving antennas/antenna boosters | 40 |
| Preparing the SKM 9000 radio microphone for use | 40 |
| Changing the microphone head | 42 |
| Preparing the SK 9000 bodepack transmitter for use | 42 |
| Connecting the antenna | 45 |
| Connecting the KA 9000 COM command adapter | 45 |
| Preparing the L 60 charger for use | 46 |
| Cascading several chargers | 46 |
| Setting up or mounting the charger | 46 |

Preparing the EM 9046 receiver for use

Setting up the receiver or mounting it into a 19" rack

Setting up the receiver on a flat surface

CAUTION

Risk of staining of furniture surfaces!

Furniture surfaces can be treated with varnish, polish or synthetics which might cause stains when they come into contact with other synthetics. Despite a thorough testing of the synthetics used by us, we cannot rule out the possibility of staining.

- ▶ Do not place the receiver on delicate surfaces.

The receiver is supplied with 4 self-adhesive soft rubber feet to ensure that it cannot slip on the surface on which it is placed.



Do not fit the device feet when rack mounting the receiver.

- ▶ Ensure that the base of the receiver is clean and free from grease before fitting the device feet.
- ▶ Fit the device feet.
- ▶ Place the receiver on a flat, horizontal surface.

Mounting the receiver into a 19" rack



CAUTION

Danger of material damage and personal injury when rack mounting the receiver!

When installing the EM 9046 in a closed or multi-rack assembly, please consider that

- the ambient temperature may increase considerably,
- high mechanical loadings occur.
- ▶ Always make sure that the ambient temperature within the rack does not exceed the permissible temperature limit specified in the specifications. If necessary, provide additional ventilation.
- ▶ Do not obstruct the air flow through the ventilation openings on the front and rear of the EM 9046.
- ▶ Always mount the receiver on rack rails.
- ▶ Make sure that the mechanical loading of the rack is even to avoid, for example, tipping of the rack.
- ▶ Make sure that the rack is sufficiently stable.
- ▶ Avoid circuit overloading. If necessary, provide overcurrent protection.
- ▶ Make sure that the mains cable of the EM 9046 as well as connected multi-outlet power strips or extension cables have protective ground contacts.
- ▶ Always ground the rack via an additional ground connection.

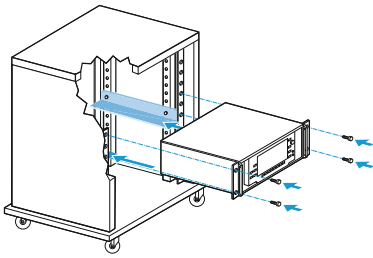

To mount the receiver into a 19" rack:

- ▶ Mount rack rails that are designed to carry the total weight of the EM 9046.
Slide the receiver onto the rack rails and screw it to the front of the rack using 2 screws per side (screws to be ordered separately).

Connecting devices to the analog audio outputs

When equipped with an AAO analog audio out module, the EM 9046 receiver has 8 analog transformer balanced audio outputs.

- ▶ Connect the analog audio inputs of an external device to the XLR-3 sockets ⑬ or the sub-D socket ⑭ (multicore, Tascam) of the EM 9046.

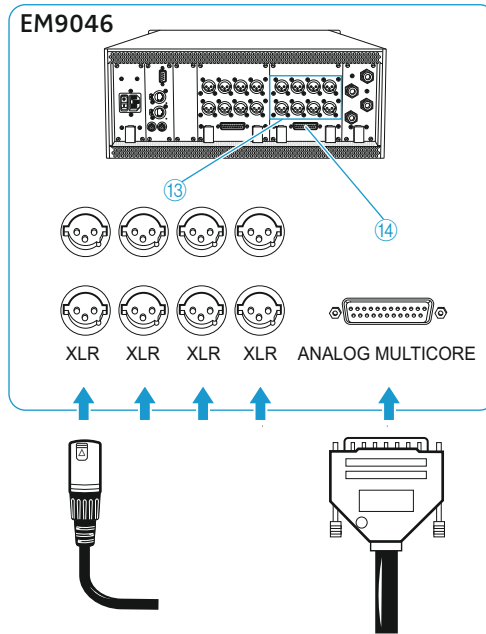

Connecting devices to the digital audio outputs

When equipped with an DAO digital audio out module, the EM 9046 receiver has 8 digital balanced audio outputs. The signals are output in AES3 format.

- ▶ Connect the digital audio inputs of an external device to the XLR-3 sockets ⑪ or the sub-D socket ⑫ of the EM 9046.

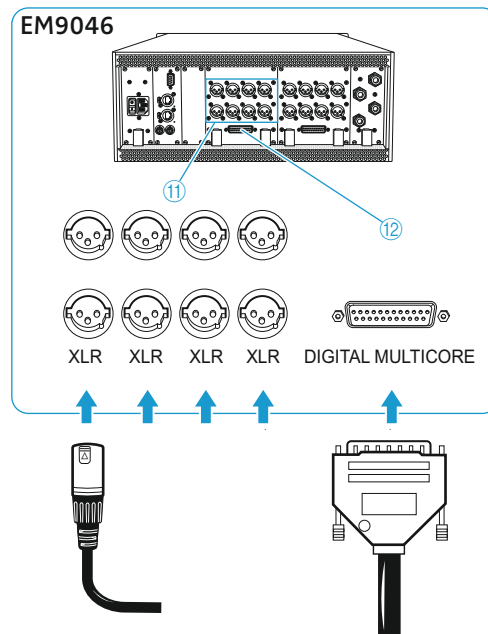

If you are using the XLR-3 sockets ⑪:

- ▶ Use a special double-shielded 110 Ω AES3 cable. This prevents that the digital data transmission interferes with RF reception.

i For the pin assignment of the XLR-3 and sub-D sockets of the EM 9046, refer to the chapter "Specifications" on page 123.

Ready-made AES3 cables are available from Sennheiser (optional accessories).

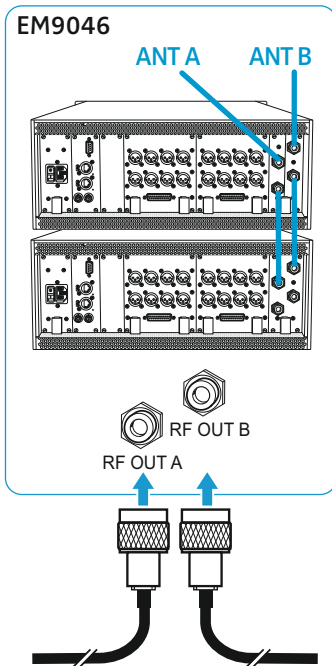

Daisy chaining receivers

The EM 9046 receivers feature an integrated antenna splitter so that up to four receivers can be daisy chained. This allows you to use two antennas/ antenna boosters for up to four receivers. In this case, all receivers have to use **the same** booster frequency range.

- ▶ Use GZL 9000 antenna cables to connect two antennas via antenna boosters to the **RF IN** N-type sockets 15 and 16 of the first receiver.
- ▶ Connect the **RF OUT** N-type sockets of the first receiver to the **RF IN** N-type sockets of an additional receiver. To do so, use the RF patch cables from the EM 9046 CAB cable set.
- ▶ Repeat the previous steps for up to four receivers.

i The length of the RF patch cables from the EM 9046 CAB cable set allows a distance of 1 height unit (HU) between two EM 9046 in a 19" rack.

If you want to pass on word clock signals between daisy chained receivers and/or if you want to connect daisy chained receivers in a network (see the following chapters):

- ▶ Connect the receivers in the same order in which you connected the **RF** N-type sockets. Always connect the network sockets from **LAN DOWN** to **LAN UP** and word clock sockets from **OUT** to **IN**.

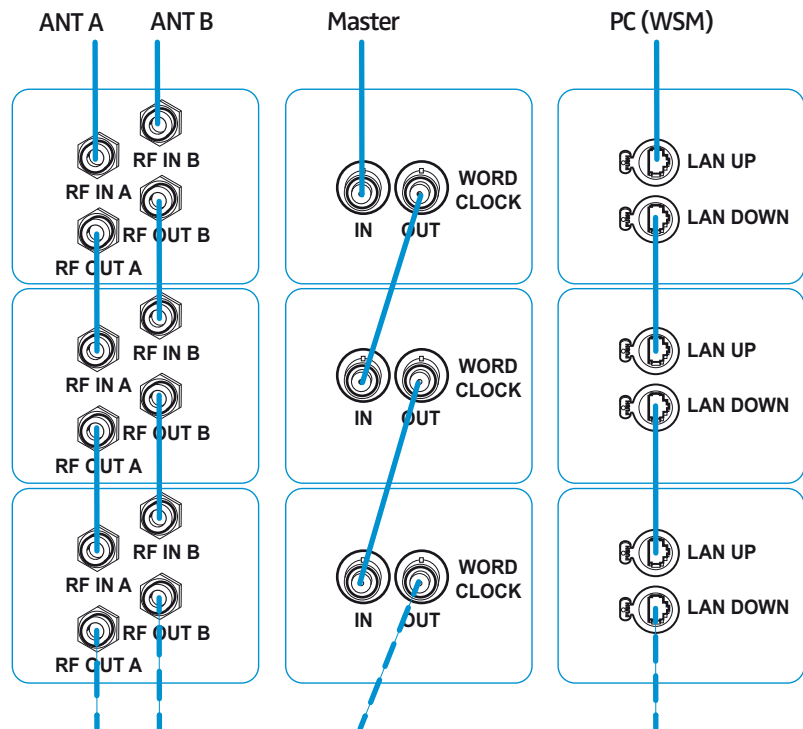

* If you have installed a MAN card in the first receiver of the daisy chain and if you use the card's word clock as the external master, the connection to the external word clock generator is no longer required (see next section).

** This diagram illustrates a convenient way of daisy chaining the receivers. Sennheiser recommends using an external switch to connect the receivers in a star topology (see "Connecting receivers in a network" on page 36).

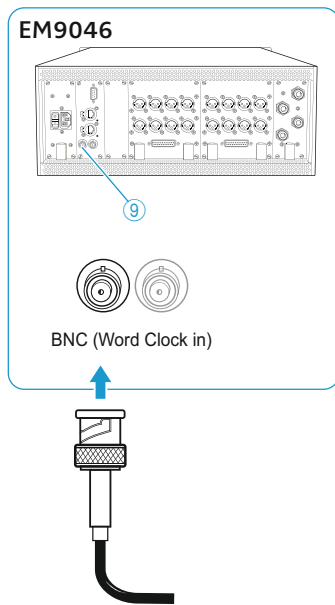

Connecting external word clock signals

The EM 9046 receiver supports external word clock sampling rates of 44.1 kHz, 48 kHz, 88.2 kHz and 96 kHz. If you have installed a MAN card, you can alternatively use the card's word clock as external word clock generator.

- ▶ (This step is not required if you use the word clock signal of a built-in MAN card.)
Use a shielded 75 Ω coaxial BNC cable to connect the word clock output of an external word clock generator to the BNC socket ⑨ of the EM 9046.

- ▶ Connect the BNC sockets of the receivers.

If you have daisy chained your receivers (see page 35):

- ▶ Connect the BNC sockets of the receivers in the order shown on page 35.

i For an overview of the states of the **clock** LED, refer to page 20.

Connecting receivers in a network

The EM 9046 has two network sockets **LAN UP** ③ and **LAN DOWN** ④, allowing you to connect additional EM 9046 or other network-compatible Sennheiser receivers in a network.

All receivers in the network can be controlled via the Wireless Systems Manager (WSM) software. In addition, interconnected receivers allow you to simultaneously headphone monitor the channels of all receivers and the stream arbitrary channels to an external audio player or to the WSM.

There are two ways to connect several EM 9046 in a network:

1. Ethernet daisy chaining:

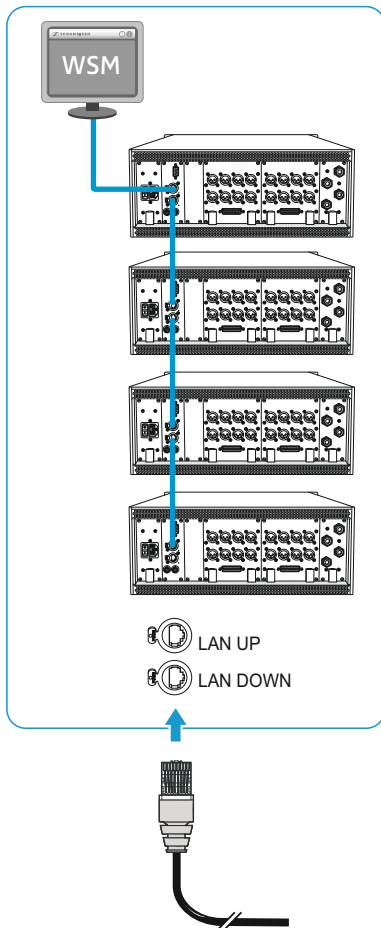

- You use both network sockets ([LAN UP](#) and [LAN DOWN](#)) of the receivers. This causes the receivers to act as a switch. You do not require an external switch.
- The Spanning Tree Protocol (STP) and/or the Rapid Spanning Tree Protocol, (RSTP) are used to detect and deactivate redundant paths in the local network. Redundant paths are caused by faulty cabling (unintentional cabling loops).
- STP and RSTP exchange configuration packets and, as a result, induce a higher network load. Individual switches in your local network can be set to a standby mode so that a loop-free network topology results. This makes your network faster and more efficient.

If a connection fails, STP and RSTP automatically attempt to reestablish the failed connection (e.g. by reactivating switches). This can cause network outages of up to 50 seconds.

- ▶ Connect the first EM 9046 to a switch, PC or laptop. We recommend using a CAT5 Ethernet cable with crush-resistant Neutrik EtherCon connectors.
- ▶ Connect the receivers to one another using the CAT5 Ethernet cables from the EM 9046 CAB cable set. Always connect the network sockets from [LAN DOWN](#) to [LAN UP](#).
- ▶ If you have daisy chained your receivers (see page 35):
- ▶ Connect the network sockets of the receivers in the order shown on page 35.

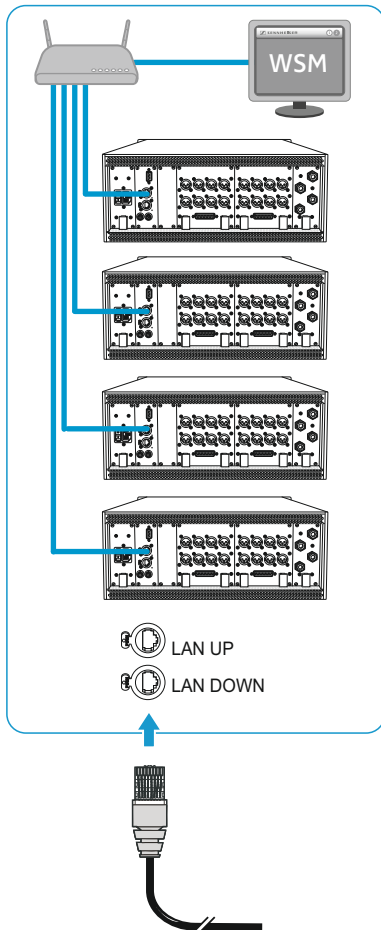

2. Connecting the receivers in a star topology (recommended):
- You only use the [LAN UP](#) network socket of the receivers. This deactivates STP and RSTP.
 - You require an external switch.
 - Your network uses a star topology
 - ▶ Connect all EM 9046 to a switch using the CAT5 Ethernet cables from the EM 9046 CAB cable set
 - ▶ Connect the switch to a computer or laptop. We recommend using a CAT5 Ethernet cable with crush-resistant Neutrik EtherCon connectors.

Connecting the receiver to the mains



CAUTION

Damage to the device due to electric current!

If you connect the receiver to an unsuitable power supply, this can cause damage to the device.

- ▶ Use the supplied mains cable to connect the receiver to the mains (100 to 240 V AC, 50 or 60 Hz).
- ▶ Ensure a reliable mains ground connection of the receiver – especially when you are using multi-outlet power strips or extension cables.

To connect the receiver to the mains:

Set the ON/OFF switch ① to position “0”.

- ▶ Connect the supplied mains cable to the 3-pin mains socket ②.
- ▶ Plug the mains connector into the wall socket.
- ▶ Set the ON/OFF switch ① to position “1”.

To disconnect the receiver from the mains:

- ▶ Set the ON/OFF switch ① to position “0”.
All daisy chained signals are interrupted, i.e.:
 - the antenna signals at the daisy chain outputs ⑰ and ⑱,
 - the booster supply voltage,
 - the signal of the external word clock generator.
- ▶ Pull out the mains connector from the wall socket to completely disconnect the receiver from the mains.

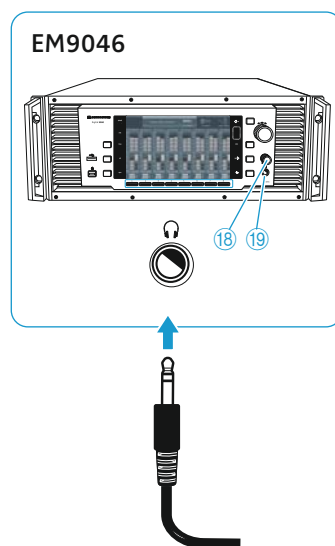
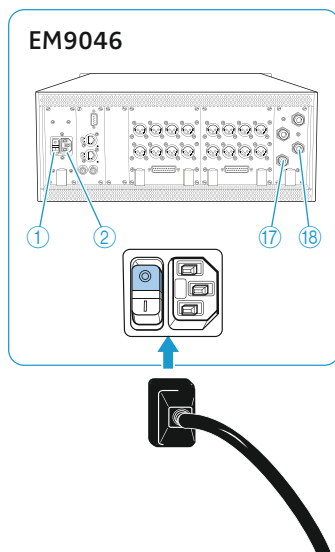

Connecting headphones



WARNING

Danger of hearing damage due to high sound pressure levels!

The headphones connected to the headphone socket are capable of producing very high sound pressure levels, which can cause permanent hearing damage.

- ▶ Always turn the headphone volume control ⑱ counterclockwise to the minimum
 - before connecting headphones and putting them on;
 - before you change to a different channel.

- ▶ First turn the headphone volume control ⑱ counterclockwise to the minimum.
- ▶ Connect headphones with a 1/4" (6.3 mm) stereo jack plug to the headphone socket ⑱.

i For information on headphone monitoring of channels, refer to page 84.

Preparing the A/AB/AD 9000 antennas and/or antenna boosters for use

Antennas and antenna boosters of the Digital 9000 series are available in two variants: A1–A8 and B1–B8.

- ▶ Select the booster variant (A1–A8 or B1–B8) whose frequency range matches that of your transmitters:

| Booster variant | A1–A8 470–638MHz | | | | | | | | B1–B8 630–798MHz | | | | | | | |
|--------------------------|---------------------------|---------|---------|---------|---------------------------|---------|---------|---------|---------------------------|---------|---------|---------|---------------------------|---------|---------|---------|
| Booster frequency ranges | A1 | A2 | A3 | A4 | A5 | A6 | A7 | A8 | B1 | B2 | B3 | B4 | B5 | B6 | B7 | B8 |
| Bandwidth MHz | 470–494 | 494–518 | 510–534 | 534–558 | 550–574 | 574–598 | 590–614 | 614–638 | 630–654 | 654–678 | 670–694 | 694–718 | 710–734 | 734–758 | 750–774 | 774–798 |
| Transmitter | type A1–A4 470–558 MHz | | | | type A5–A8 550–638 MHz | | | | type B1–B4 630–718 MHz | | | | type B5–B8 710–798 MHz | | | |

- ▶ Use two A 9000 receiving antennas **or** two AD 9000 receiving antennas **or** two passive antennas together with AB 9000 antenna boosters:

| Product name | Type | Radiation pattern |
|--------------|---------------------|---------------------------------------|
| A 9000 | active, intelligent | omni-directional |
| AD 9000 | active, intelligent | directional |
| AB 9000 | antenna booster | depending on the passive antenna used |

If both antenna boosters are connected or replaced, the EM 9046 automatically measures the cable attenuation between the antenna boosters and the antenna inputs and compensates for it. During the measurement, the channel status display displays “Calibrating” for each channel. If only one antenna booster is connected or replaced, the cable attenuation will not be measured. You can also manually initiate the compensation of the cable attenuation (see ““Cable attn” – Displaying the cable attenuation and automatically compensating for it” on page 64).

Positioning the receiving antennas



CAUTION

Material damage and personal injury due to tipping/dropping of the antennas!

If you do not protect the antennas against tipping/dropping, they can cause material damage and personal injury.

- ▶ Use safety wires to protect the receiving antennas against tipping/dropping. The safety wires, rope terminations and coupling links must comply in their dimensioning and condition with the regulations and standards of the country in which they are used!

- ▶ Position the receiving antennas in the same room in which the transmission takes place! Maintain a minimum distance of 1 m between the two receiving antennas/antenna boosters and a minimum distance of 50 cm between the antennas/antenna boosters and metal objects (including reinforced concrete walls).

Connecting the receiving antennas/antenna boosters

- ▶ Use GZL 9000 antenna cables.

i Sennheiser GZL 9000 antenna cables are available in lengths of 5 m, 10 m and 20 m.

A/AB/AD 9000:

- ▶ Connect the **RF out** sockets ④ of the antennas/antenna boosters used to the N-type sockets **RF IN A** ⑮ and **RF IN B** ⑯ of your EM 9046.

AB 9000:

- ▶ Connect the **RF IN** socket ⑥ of the two antenna boosters to one antenna each.
- ▶ Use short cables to keep the cable attenuation as low as possible.

Adjusting the receiving antennas/antenna boosters

The EM 9046 receiver controls the preselection of the booster frequency ranges. No further settings need to be made on the A/AB/AD 9000 antennas/antenna boosters.

You can also use the antennas/antenna boosters with other receivers if the following conditions are met:

- ▶ Use a receiver with booster supply voltage (e.g. EM 3732-II).
- ▶ Use a cable whose length and attenuation match the amplification of 17 dB of the A/AD/AB 9000 antennas and antenna boosters.
- ▶ Use the "Filter" rotary switch ⑧ to manually set the booster frequency range (see table on page 39).

Preparing the SKM 9000 radio microphone for use

Selecting the accupack/battery pack

For powering the SKM 9000 radio microphone, you can use:

- the **BA 60** accupack
- the **B 60** battery pack for 2 AA size batteries (1.5 V)

i Charge the **BA 60** accupack before using it for the first time (see page 102).

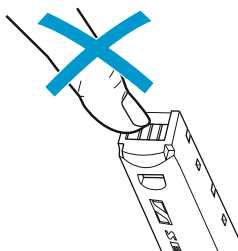

CAUTION

Damage to the radio microphone and/or the accupack/battery pack!

If you touch the following contacts, they can become dirty or damaged:

- charging and data contacts ① of the BA 60 accupack
- data contacts ④ of the B 60 battery pack
- ▶ Do not touch the contacts of the BA 60 accupack nor the contacts of the B 60 battery pack.

Inserting batteries into the B 60 battery pack

- ▶ Insert the batteries (see diagram). Observe correct polarity when inserting the batteries.

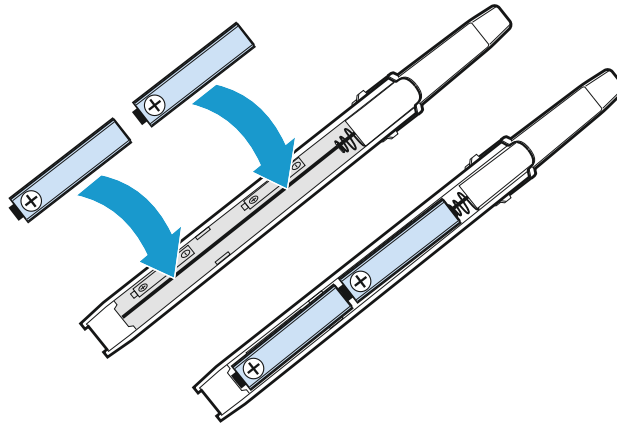

- i** Only insert high-quality AA size batteries (e.g. lithium or alkaline batteries) into the B 60 battery pack. Do not insert individual rechargeable batteries such as NiMH cells.

Removing and inserting the accupack/battery pack

To **remove** the accupack/battery pack:

- ▶ Push the two catches for accupack/battery pack ⑭ and pull the accupack/battery pack out of the radio microphone's body (see diagram 1).

- i** When removing the accupack/battery pack, the settings of the radio microphone are retained.

To **attach** the accupack/battery pack:

- ▶ Push the accupack/battery pack into the radio microphone's body until it locks into place with an audible click (see diagram 2).

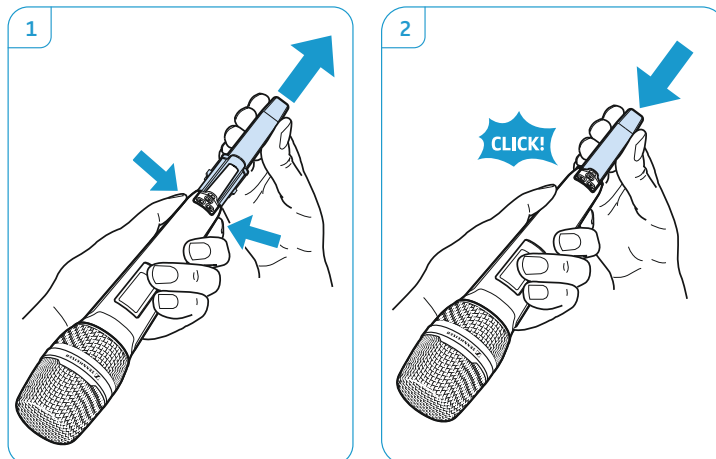

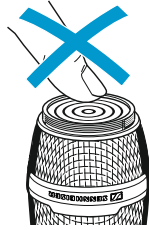

Changing the microphone head

CAUTION

Damage to the microphone head!

If you touch contacts, they can become dirty or damaged.

- ▶ Do not touch the contacts of the radio microphone nor the contacts of the microphone head.

- ▶ Unscrew the microphone head ①.

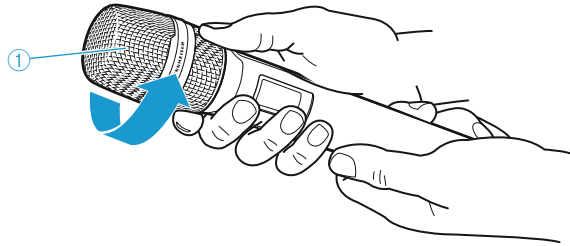

- i** With some microphone heads, the upper part of the sound inlet basket can be unscrewed. To fully unscrew the microphone head, always hold it as shown.

For an overview of suitable microphone heads, refer to the product overview on page 23.

- ▶ Screw the desired microphone head to the radio microphone. The radio microphone is operational again.

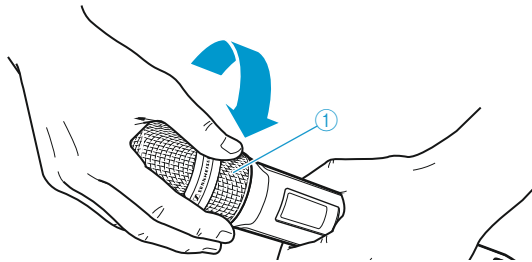

- i** When unscrewing the microphone head ① during operation, the muting function is automatically activated.

Preparing the SK 9000 bodypack transmitter for use

Selecting the accupack/battery pack

For powering the SK 9000 bodypack transmitter, you can use:

- the BA 61 accupack
- the B 61 battery pack for 3 AA size batteries (1.5 V)

- i** Charge the BA 61 accupack before using it for the first time (see page 102).

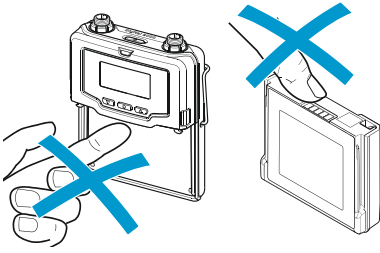

CAUTION

Damage to the bodypack transmitter and/or the accupack/battery pack!

If you touch the following contacts, they can become dirty or damaged:

- Contacts for supply voltage and data contacts of the bodypack transmitter
 - Charging and data contacts of the BA 61 accupack
 - Data contacts of the B 61 battery pack
- ▶ Do not touch the contacts of the bodypack transmitter nor the contacts of the BA 61 accupack/B 61 battery pack.

Inserting batteries into the B 61 battery pack

- ▶ Insert the batteries (see diagram). Observe correct polarity when inserting the batteries.

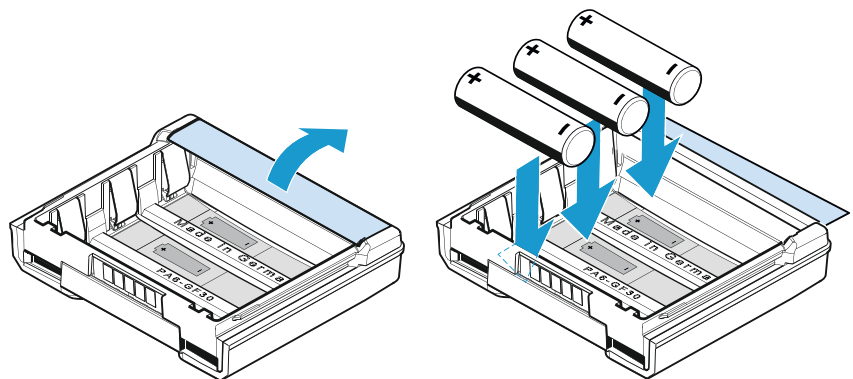

i Only insert high-quality AA size batteries (e.g. lithium or alkaline batteries) into the B 61 battery pack. Do not insert individual rechargeable batteries such as NiMH cells.

i When removing the accupack/battery pack, the settings of the radio microphone are retained.

Removing and inserting the accupack/battery pack

To **remove** the accupack/battery pack:

- ▶ Push the two catches and pull the accupack/battery pack away from the bodypack transmitter as shown in diagram 2.

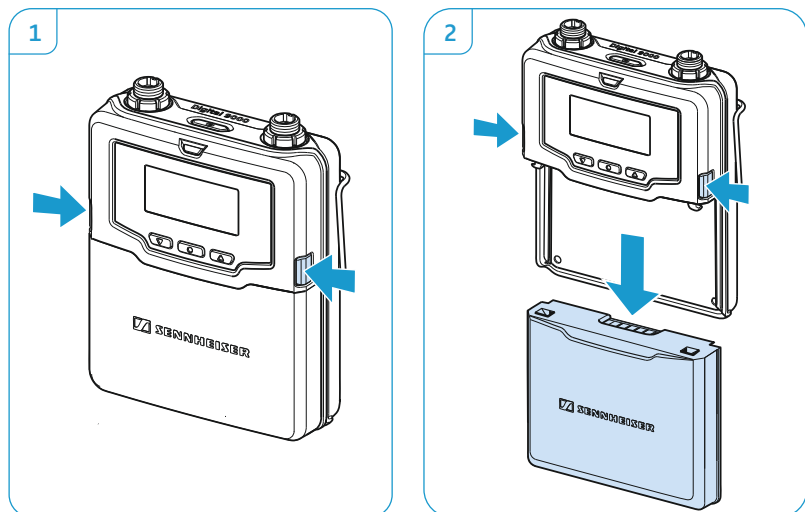

To **attach** the accupack/battery pack:

- ▶ Slide the accupack/battery pack onto the guide rails of the bodypack transmitter until it locks into place with an audible click. The bodypack transmitter is then ready for operation.

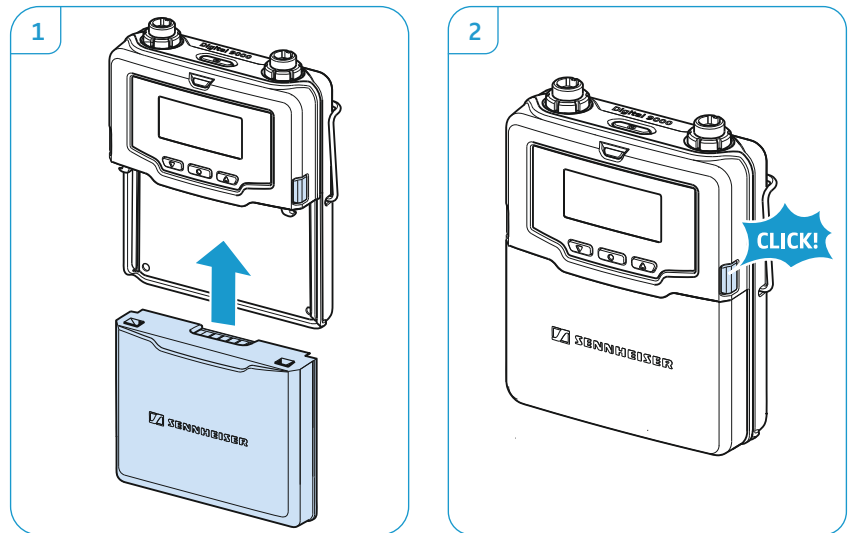

- i** When removing the accupack/battery pack, the settings of the radio microphone are retained.

Connecting microphones and audio sources

The audio input is designed for the connection of both pre-polarized condenser microphones and other audio sources. DC powering of the condenser microphones is via the 3-pin special audio socket ①.

- ▶ Use one of the recommended Sennheiser microphones or the Sennheiser CI 1-4 line/instrument cable.

- i** For an overview of suitable microphones, refer to the product overview on page 25.

- ▶ Connect the 3-pin special audio connector of the Sennheiser microphone or the Sennheiser CI 1-4 line/instrument cable to the 3-pin special audio socket ①.

- ▶ Lock the connector by screwing down the coupling ring.

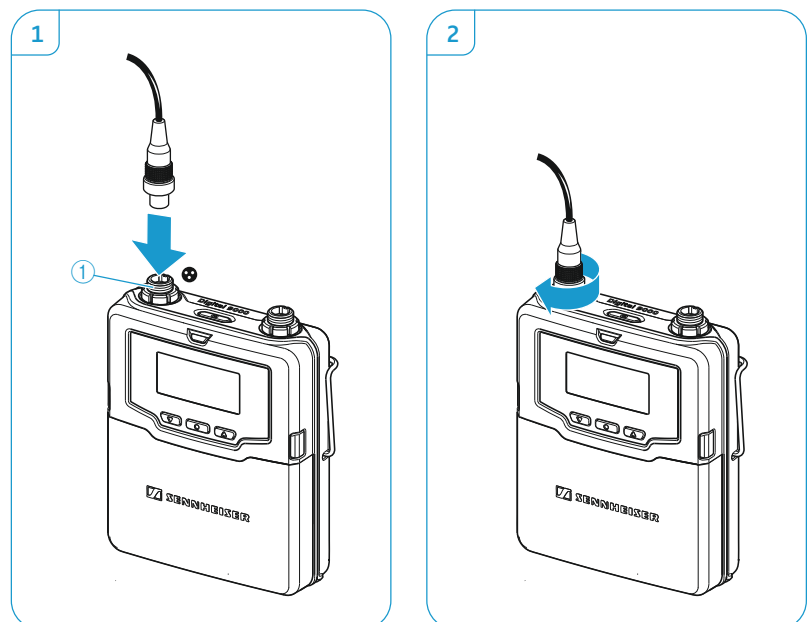

Connecting the antenna

- ▶ Only use the supplied antenna.
- ▶ Connect the antenna as shown:

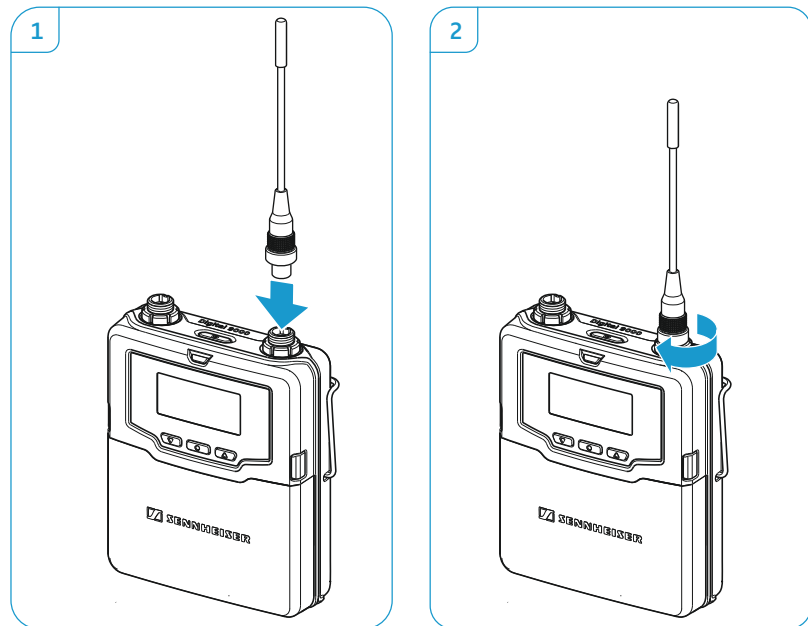

Connecting the KA 9000 COM command adapter

Using the KA 9000 COM command adapter, you can change the audio channel on the EM 9046 receiver via remote control, e.g. for stage directions.

- ▶ Connect the 3-pin special audio connector ① of the KA 9000 COM to the 3-pin special audio socket ① of the SK 9000.
- ▶ Connect the 3-pin special audio connector of the Sennheiser microphone or the Sennheiser CI 1-4 line/instrument cable to the 3-pin special audio socket ③ of the KA 9000 COM.

Preparing the L 60 charger for use

Cascading several chargers

Up to 4 L 60 charger can be cascaded together and can be powered by the NT 3-1 mains unit.

▶ Prepare the L 60 chargers:

- Make sure that the chargers are **disconnected** from the mains.
- Unscrew the two screws ⑥ at the bottom of one charger.
- Tilt the charger to the side and slide out the rails ⑤ completely.
- Tighten the two screws ⑥.

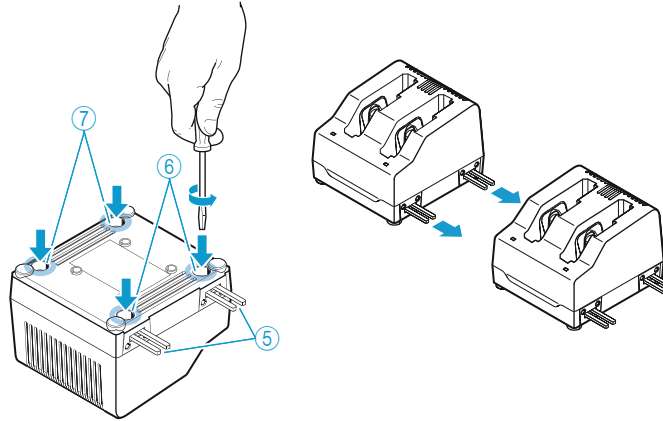

- ▶ Unscrew the two screws ⑦ at the bottom of a second charger.
- ▶ Slide the second charger onto the rails ⑤ of the first charger and tighten the two screws ⑦.
- ▶ Repeat for the other chargers.

Setting up or mounting the charger

CAUTION

Risk of staining of surfaces!

Surfaces can be treated with varnish, polish or synthetics which might cause stains when they come into contact with other materials. Despite a thorough testing of the materials used by us, we cannot rule out the possibility of staining.

- ▶ Do not place the L 60 charger on delicate surfaces.

To fix the charger securely in place:

- ▶ Fix the charger by screwing screws (fillister head self-tapping screws as per DIN 7049, ST 3.5 x 32) through the four holes ⑧ at the bottom of the charger.

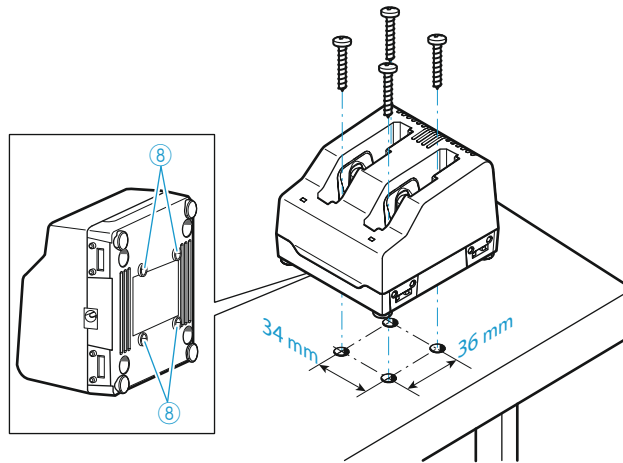

To ensure reliable operation of the L 60 and efficient charging of the BA 60/61:

- ▶ Make sure that the ambient temperature of the charger is within the operating temperature range (see page 122).
- ▶ Do not place the charger in direct sunlight or near any heat sources such as radiators, stoves, or other devices (including amplifiers) that produce heat.
- ▶ Ensure sufficient ventilation; if necessary, provide additional ventilation.

Digital 9000 Using the EM 9046



| | | | |
|---|----|---|----|
| Using the EM 9046 | 49 | Main menu "System setup" | 56 |
| Using the EM 9046 receiver | 50 | Extended menu "Service setup" | 67 |
| Switching the receiver on/off | 50 | "ch" operating mode – Configuring channels | 76 |
| "sys", "ch", "live" – operating modes at a glance ... | 51 | Overview of the "ch" menu | 76 |
| Basic functions of the Sennheiser operating menu . | 51 | Main menu "Channel setup" | 77 |
| Displays of the Sennheiser operating menu | 52 | Extended menu "Transmitter setup" | 81 |
| Error and warning messages | 53 | "live" operating mode – Using a configured system | 84 |
| "sys" operating mode – Configuring the system | 55 | | |
| Overview of the "sys" menu | 55 | | |

Using the EM 9046 receiver

Switching the receiver on/off

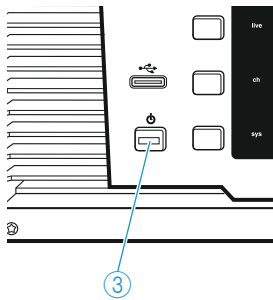

To switch the receiver on:

- ▶ Make sure the **ON/OFF** switch ① is set to position “1”.
- ▶ Press the standby button ③.

The receiver’s operating system is loaded. During loading, the LED of the standby button ③ flashes red and the display panel shows the Sennheiser start screen. Then, an automatic calibration of the cable attenuation is performed (see page 64).

Once the operating system is fully loaded, the receiver is in “live” operating mode.

To switch the receiver to standby mode:

- ▶ Keep the standby button ③ pressed for approx. 4 seconds until the display panel goes completely off.

The receiver is in standby mode. All the interferences levels recorded during the frequency scans are deleted. The activated booster frequency range and the frequency presets assigned to the channels are stored.

To completely switch the receiver off and disconnect it from the mains:

- ▶ Set the **ON/OFF** switch ① to position “0”.
All daisy chained signals are interrupted, i.e.:
 - the antenna signals at the daisy chain outputs ⑰ and ⑱,
 - the booster supply voltage,
 - the signal of the external word clock generator.
- ▶ Pull out the mains plug from the wall socket to completely disconnect the receiver from the mains.

“sys”, “ch”, “live” – operating modes at a glance

“live” operating mode – Live transmission



In this mode, you can check, among other things, the following parameters during transmission:

- RF level
- True bit diversity evaluation
- Audio level
- Charge status of the BA/B 60/61 accupack/battery pack
- Remaining operating time of the BA 60/61 accupack

More information on the “live” operating mode can be found from page 84 onwards.

“ch” operating mode – Setting up channels



In this mode, you can configure channels on the receiver and then synchronize the transmitters and the receiver. More information on the “ch” operating mode can be found from page 76 onwards.

“sys” operating mode – Configuring the system



In this mode, you can configure transmitters and the receiver. More information on the “sys” operating mode can be found from page 55 onwards.

Basic functions of the Sennheiser operating menu

A special feature of the Sennheiser 9000 series is the straightforward, intuitive operating concept. As a result, you can act quickly and precisely – even in stressful situations, for example on stage or during a live show or presentation.

Selecting the operating mode

- ▶ Press the respective button to select the desired operating mode.



Calling up and selecting menu items, changing and storing settings, cancelling an entry

In “ch” and “sys” operating mode, the following operating elements are available:

Jog dial



- ▶ Turn the jog dial to select a different menu item or a different setting.



- ▶ Press the jog dial to call up a menu item or to confirm a selection.

save button



- ▶ Press the save button  to store settings.

esc button



- ▶ Press the esc button to cancel entries.

In addition, in “ch” operating mode, the channel 1–8 button ⑳ and the multiple channel selection button + ㉑ are available:

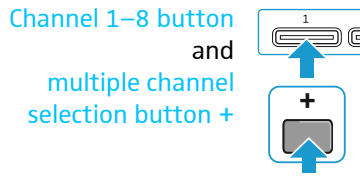

- ▶ Select a channel or press the multiple channel selection button + ㉑ and then select several channels simultaneously.

i The channel 1–8 button ⑳ and the multiple channel selection button + ㉑ are also available in “live” operating mode.

Displays of the Sennheiser operating menu

The Sennheiser operating menu consists of the **menu selection** in the upper part, where you can select and call up menu items, and the **main screen** in the lower part:

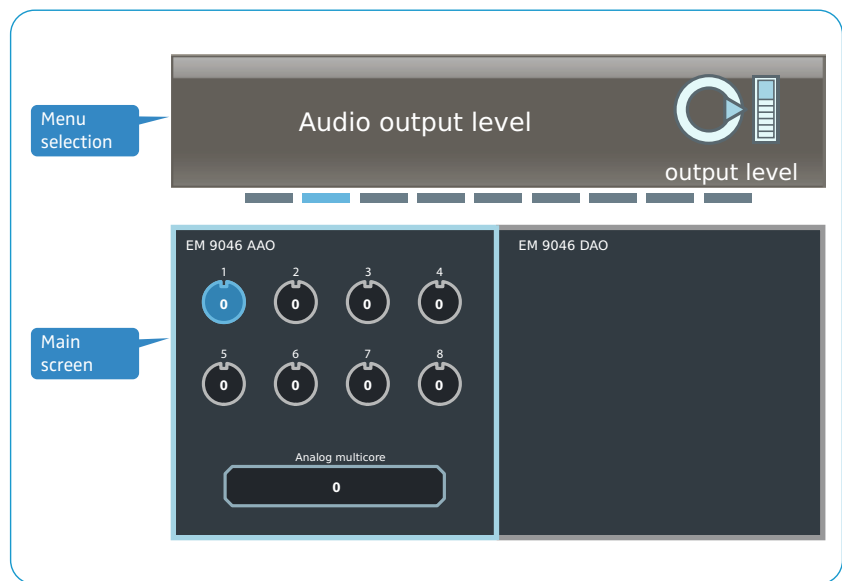

Menu selection

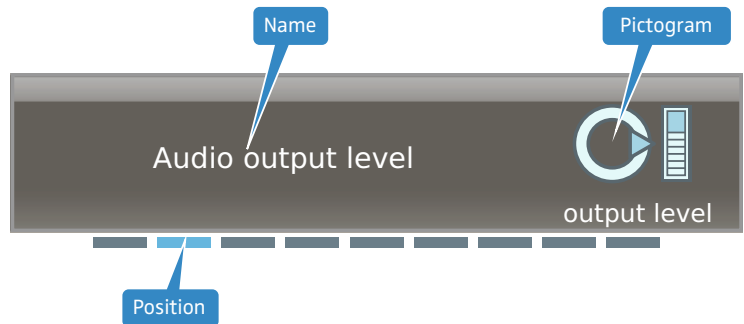

The name of the menu item, a pictogram and the position of the menu item in the current operating menu are displayed in the menu selection.

If you call up a menu item by pressing the jog dial , the menu selection is framed in blue:

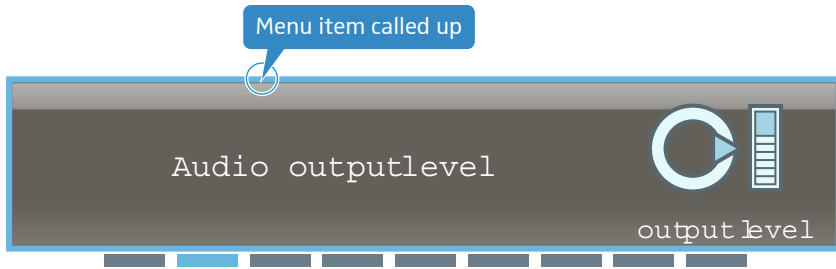
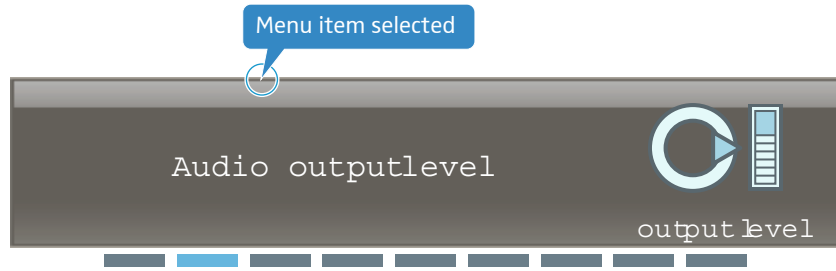

When a menu item has only a few options to choose from, this can be done directly via the menu selection (see for example the “word clock” menu item on page 64).

When a menu item has extended options, the settings are adjusted on the main screen (here by way of example of the “Audio output level” menu item):

Main screen

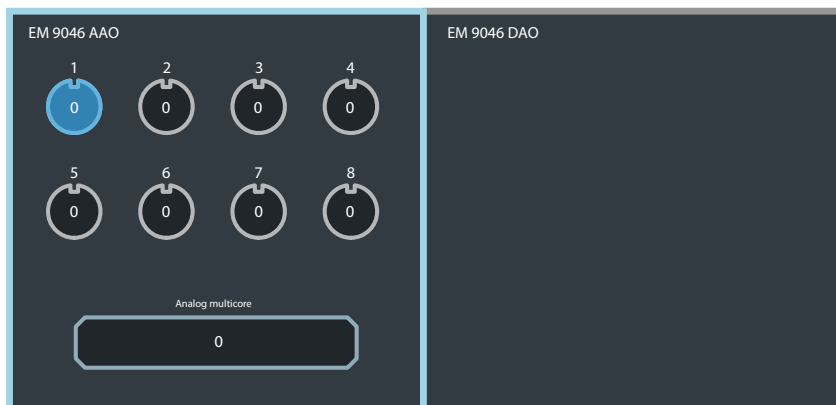

Error and warning messages

Error and warning messages are displayed in white letters. The display panel is highlighted in orange.

Example: "Frequency out of booster range" warning message

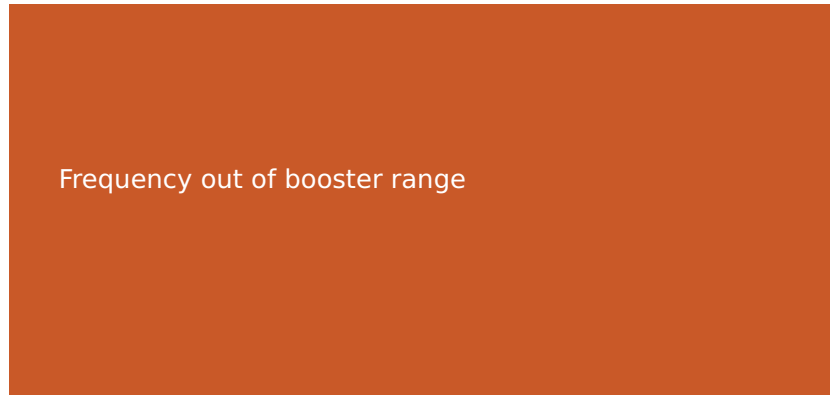

















You can hide error/warning messages by pressing the `esc` button . In order to check if errors or warnings are still present, you can call up the "System check" menu item in the extended menu "Service setup" of the system menu. For more information, refer to page 70.



“sys” operating mode – Configuring the system

In “sys” operating mode, you can configure the transmitters and the receiver.

Overview of the “sys” menu

| Main menu “System setup” | | | Page |
|---|--------------------|--|------|
|  | Frequency scan | Performs a frequency scan of all 8 frequency ranges | 56 |
|  | Range detail scan | Performs a frequency scan of the active frequency range Assigns frequency presets to the channels | 60 |
|  | Audio output level | Adjusts the output level | 63 |
|  | Word clock | Configures the word clock | 64 |
|  | Cable attn | Displays the cable attenuation between booster output and RF input of the EM 9046 and compensates for it | 64 |
|  | Load config | Loads a configuration | 65 |
|  | Save config | Saves a configuration | 65 |
|  | Network | Configures the network | 66 |
|  | Brightness | Adjusts the brightness | 66 |
|  | Screensaver | Selectable settings: ON/OFF The default setting of the “Screensaver” menu item is ON | 67 |
|  | Service setup | Calls up the extended menu “Service setup” | 56 |

| Extended menu “Service setup” | | | Page |
|---|---------------|---------------------------------------|------|
|  | System setup | Calls up the main menu “System setup” | 56 |
|  | Factory reset | Loads the factory default settings | 68 |
|  | Date & time | Adjusts the date and time | 69 |
|  | Op hours | Displays the operating hours | 69 |
|  | Log | Displays the event logs | 69 |
|  | System check | Displays the system status | 70 |

| Extended menu "Service setup" | | | Page |
|---|----------|--|------|
|  | HW setup | Displays the hardware configuration and status | 70 |
|  | Firmware | Displays the firmware versions and updates the firmware of the transmitters and boosters | 73 |
|  | Legal | License and copyright information | 75 |

Main menu "System setup"

To get into the main menu:

- ▶ Select the "sys" operating mode.

"Frequency scan" – Performing a frequency scan of all 8 frequency ranges

The main menu contains two menu items that allow you to perform a frequency scan:

1. First, use the "Frequency scan" menu item to find and activate a suitable booster frequency range.
2. Then use the "Range detail scan" menu item to assign frequency presets from the activated booster frequency range to the channels. Optionally, you can perform a new frequency scan of the activated booster frequency range.

You can then adjust the settings to be transferred to your transmitters and synchronize the transmitters and the receiver via infra-red.

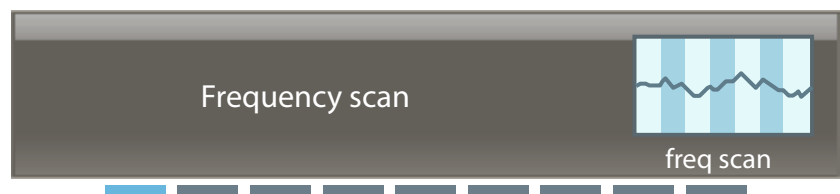

During the frequency scan ("Frequency scan" menu item), the interference levels received by the antennas are recorded and displayed for the booster frequency ranges 1 to 8.

Before performing a frequency scan, carry out the following steps:

- ▶ Switch **off** all transmitters that you want to wirelessly connect to the EM 9046.
- ▶ Switch **on** all possible sources of interference (e.g. light sources, intercom links, video walls) and all other transmission links.

To perform a frequency scan:

- ▶ Call up the "Frequency scan" menu item.

If a frequency scan has already been performed, the last activated booster frequency range is highlighted in blue.

- ▶ Turn the jog dial (17) until the text "start scan" at the bottom margin of the screen is highlighted in blue:

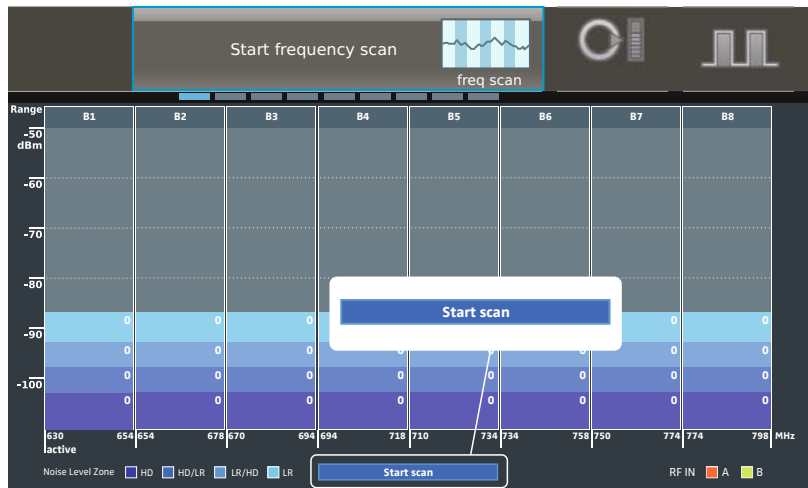

- ▶ Start the frequency scan by pressing the jog dial (17).
Please note: All audio outputs will be muted!

i The duration of the frequency scan depends on the number of the built-in EM 9046 DRX receiver modules. The more modules you use, the faster the frequency scan is performed.

The interference levels received by the antennas are recorded and displayed. The interference levels are divided into four interference zones: "HD", "HD/LR", "LR/HD" and "LR". The lower the zone, the lower the received interference level.

In addition, the number of unused frequency presets is displayed per booster frequency range and per interference zone. The number of unused frequency presets depends on the number, the height and the frequency of the received interference levels.

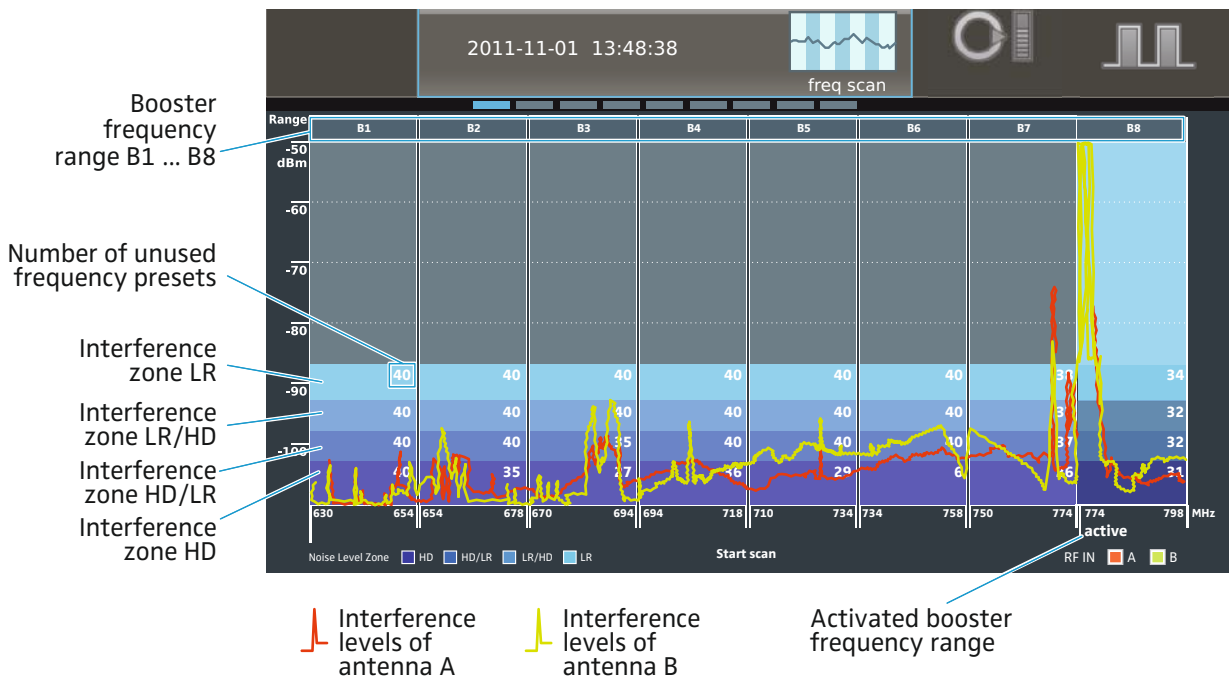

The selection of a suitable booster frequency range depends on several factors:

- Required number of transmission links
- Sufficient number of unused frequency presets
- Sufficient number of transmitters of the correct type (in this example, transmitters of type B1–B4 or B5–B8, see page 39)
- Recommended transmission mode "HD" or "LR":

"HD (High Definition)": Transmission of an audio signal without audio data compression. As a result, the audio signal remains pure and unadulterated. In "HD" transmission mode, the range can be restricted compared to "LR" transmission mode.

"LR (Long Range)": Transmission of an audio signal whose bit rate is reduced – before transmission – by an audio data compression technique (SeDAC, Sennheiser Digital Audio Codec). This compression technique provides excellent audio quality and a large transmission range. The sensitivity to interference is reduced compared to "HD" transmission mode.

| Interference levels of antenna A/B in interference zone | ■ "HD" | ■ "HD/LR" | ■ "LR/HD" | ■ "LR" |
|---|--------|---------------|---------------|--------|
| Recommended transmission mode | "HD" | "HD"* or "LR" | "LR" or "HD"* | "LR" |

* Transmission mode can be used with a restricted range

** It might be that the transmission mode can only be used with a severely restricted range

Let us assume that you want to set up 8 transmission links and transmit in "HD" transmission mode with the maximum possible transmission range.

Have a look at interference zone "HD" (see also above diagram): All booster frequency ranges except for B6 provide a sufficient number of unused frequency presets.

| Booster frequency ranges | B1 | B2 | B3 | B4 | B5 | B6 | B7 | B8 |
|--|----|----|----|----|----|----|----|----|
| Number of unused frequency presets in interference zone "HD" | 40 | 35 | 27 | 36 | 29 | 6 | 26 | 31 |
| Can the booster frequency range be used? | ✓ | ✓ | ✓ | ✓ | ✓ | – | ✓ | ✓ |

Example 1: 8 transmitters of type B1–B4

Let us assume that you have 8 transmitters of type B1–B4:

| Is there a sufficient number of transmitters of the correct type? | ✓ | ✓ | ✓ | ✓ | – | – | – | – |
|---|---|---|---|---|---|---|---|---|
|---|---|---|---|---|---|---|---|---|

You can use any of the booster frequency ranges B1–B4 but you should select the booster frequency range with the highest number of unused frequency presets: B1.

Example 2:
 6 transmitters of type B1–B4,
 8 transmitters of type B5–B8

Let us assume that you have only 6 transmitters of type B1–B4 but 8 transmitters of type B5–B8.

| | | | | | | | | |
|---|---|---|---|---|---|---|---|---|
| Is there a sufficient number of transmitters of the correct type? | - | - | - | - | ✓ | ✓ | ✓ | ✓ |
|---|---|---|---|---|---|---|---|---|

The number of transmitters is sufficient but the booster frequency range B6 does not provide a sufficient number of unused frequency presets in interference zone “HD”. You could therefore use the booster frequency ranges B5, B7 or B8 but you should select the booster frequency range with the highest number of unused frequency presets: B8.

In this example, there was a sufficient number of unused frequency presets available for interference zone “HD”, allowing you to adjust the “HD” transmission mode for all channels. If this is not the case, you can, in a later step, also adjust the “LR” transmission mode for individual channels.

To activate the booster frequency range:

- ▶ Select a suitable booster frequency range by turning the jog dial ⑰. The frequency range is highlighted in blue.
- ▶ Activate the booster frequency range by pressing the jog dial ⑰. “active” appears below the activated booster frequency range (see above diagram). You can still change your selection by choosing a different booster frequency range and then pressing the jog dial ⑰ again.
- ▶ Finish the frequency scan and store the previously activated range by pressing the **Save** button ⑱.
- ▶ Assign frequency presets to the channels as described in the next section.

“Range detail scan” – performing an optional frequency scan of the active frequency range and assigning frequency presets to the channels

- ▶ Call up the **“Range detail scan”** menu item.
The activated booster frequency scan and the result of the last frequency scan (**“Frequency scan”** or **Range detail scan**) are displayed. **“Select channel or press SET to scan”** appears in the menu selection.

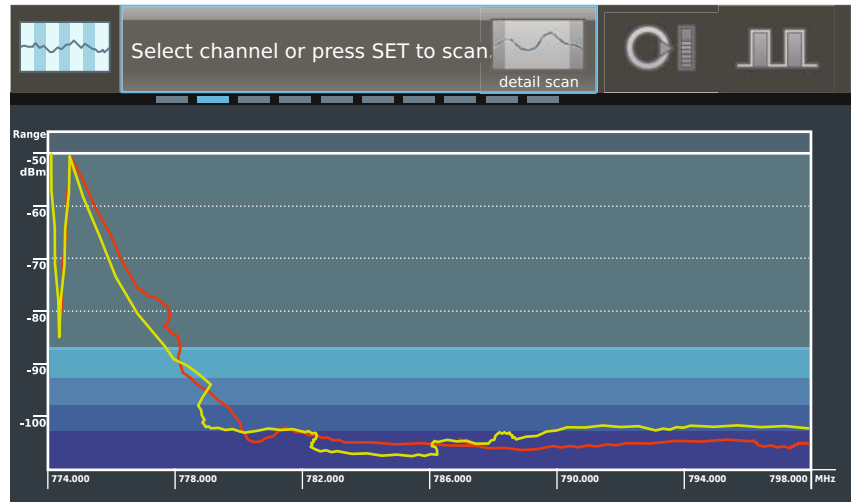

You can now perform a new frequency scan of the activated booster frequency range (optional) or immediately assign frequency presets to the channels.

Performing a frequency scan

To perform a new frequency scan of the activated booster frequency range (optional):

- ▶ Start the frequency scan by pressing the jog dial ⑰.
- Please note:** All audio outputs will be muted!

Assigning frequency presets to the channels

To assign frequency presets to the channels:

- ▶ Select one of the channels 1–8 by pressing its channel button ⑳.
- A mark with a flag and a channel number appears.

Numeric measured values

Selected frequency preset

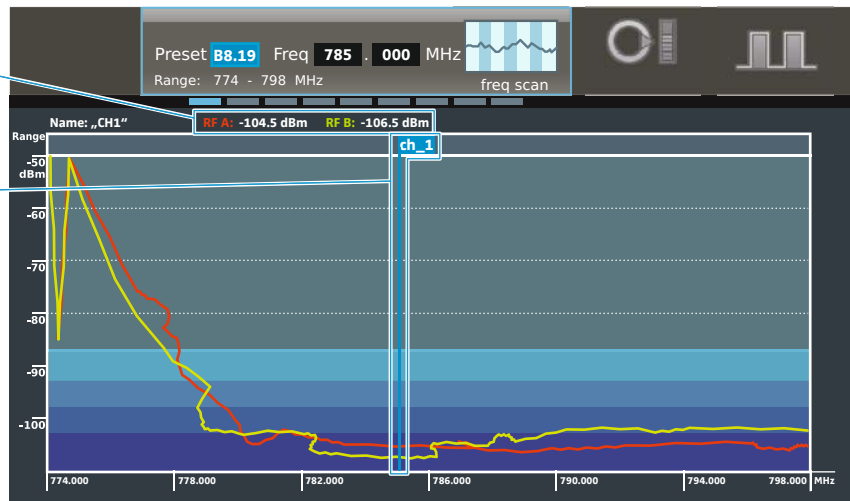

- **“HD”**
- **“HD/LR”**
- **“LR/HD”**
- **“LR”**

There are three ways to assign a frequency preset or a frequency to a channel:

1. You can automatically select the frequency preset with the lowest interference level. This is the quickest and most convenient way of assigning a frequency to a channel.
2. You can manually select a frequency preset.
3. You can manually set an arbitrary frequency.

Automatically selecting a frequency preset

To automatically select the frequency preset with the lowest interference level, proceed as follows:

- ▶ Turn the jog dial until “auto” appears.

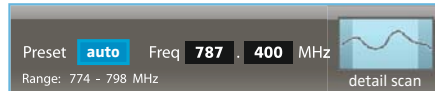

After the frequency scan, the receiver automatically creates an ordered list containing the 32 frequency presets with the lowest interference levels. The frequency presets in the list are ordered according to increasing interference levels.

The first frequency level in the list has the lowest interference levels. The mark automatically snaps into position on this frequency preset and the corresponding frequency value is displayed.

The numeric values of the measured interference levels for antenna A and antenna B are additionally displayed at the top margin of the screen.

- ▶ Press the jog dial.
The selected channel is assigned the frequency preset with the lowest interference level.



Please note that the frequency presets are assigned in the order of increasing interference levels:

- The first channel is assigned the frequency preset with the lowest interference levels.
- The second channel is assigned the frequency preset with the next higher interference levels.
- The last channel is assigned the frequency preset with the highest interference levels.

You should therefore use the first channel for the most important transmission link in your multi-channel system.

Each new frequency scan creates a new frequency preset list.





Manually selecting a frequency preset

To manually select an unused frequency preset, proceed as follows:

- ▶ Move the mark by turning the jog dial .
The mark snaps into position on the frequency presets.
- ▶ Select a frequency preset.

The numeric values of the measured interference levels for antenna A and antenna B are additionally displayed at the top margin of the screen.

The interference levels of both antennas should be within or below the interference zone that is required or useful for this channel (see page 56 and 58) and should be as low as possible.

- Manually setting a frequency
- If you do not want to use a frequency preset but you want to set a frequency yourself, proceed as follows:
- ▶ Press the jog dial.
Each time you press the jog dial, you switch between
 - the “Preset” settings,
 - the frequency setting in MHz steps and
 - the frequency setting in kHz steps.
 - ▶ First set the frequency in MHz steps by turning the jog dial. Press the jog dial to confirm your setting.
 - ▶ First set the frequency in kHz steps by turning the jog dial. Press the jog dial to confirm your setting.
- Maintain a frequency spacing of at least 600 kHz in order to avoid inter-modulation interference.
- Please observe the flag position of the selected frequency preset: If the flag appears on the left or right margin and is pointing outwards, the frequency is outside the selected booster frequency range.
- Assigning frequencies to the remaining channels
- ▶ Select the next channel 1 ... 8 by pressing the channel 1–8 button  and proceed as described above.
All frequencies assigned to a channel are displayed by means of a mark with a flag and a channel number. If you have daisy chained several receivers (see “Daisy chaining receivers” on page 35), their frequency settings are also displayed in contrasting colors. This allows an overview over up to 32 channels.
 - ▶ Once you have selected a frequency preset for all desired channels, press the  button .
Your settings are stored and the receiver switches to the main menu “System setup”.
- To switch to the main menu without storing your settings:
- ▶ Press the  button .
- To configure your transmitters:
- ▶ Change to the “ch” operating mode on the EM 9046 (see page 76).
 - ▶ Select one of the channels for which you have stored frequency presets.
 - ▶ Call up the extended menu “Transmitter setup” and then call up the “RF mode” menu item.
 - ▶ Adjust the transmission mode (“HD” or “LR”) depending on the interference zone of the channel (see also table on page 59).
 - ▶ Configure your channels as described from page 76 onwards.
 - ▶ Synchronize the transmitters and the receiver as described on page 77.
 - ▶ Repeat for the other channels.
 - ▶ Perform a walk test to check the reliability of your transmission links (see page 80).
 - ▶ Change the transmission mode for the channels with reception problems and then synchronize the transmitters and the receiver again.
 - ▶ If the reception problems persist, select a different booster frequency range.

“Audio output level” – Adjusting the analog output levels

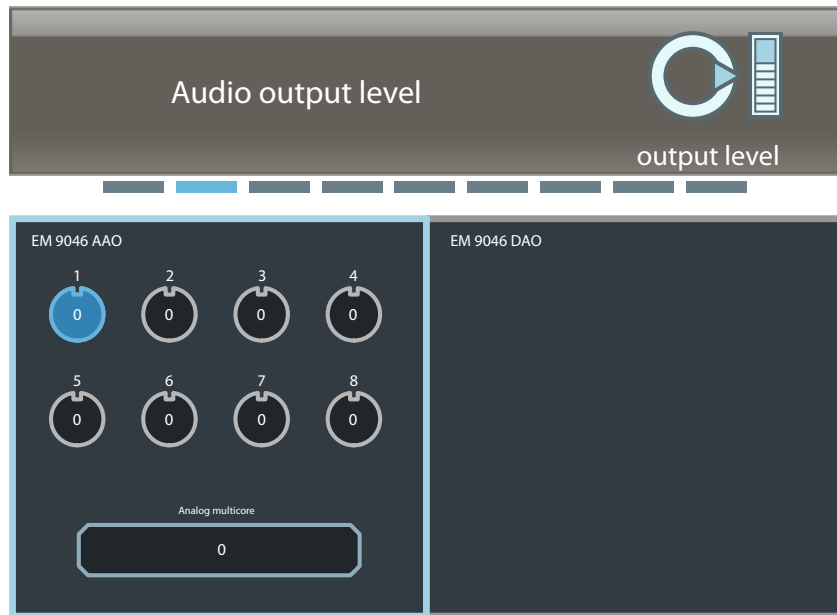

Via the “Audio output level” menu item, you can adjust the level of all or individual channels of the Analog Audio Out (AAO) module.

- ▶ Call up the “Audio output level” menu item.
The installed audio modules are displayed as follows:
 - digital audio modules: “Slot digital”;
 - analog audio modules: “Slot analog”;
 - not installed audio modules: “Slot not available”.
- ▶ Select individual or all channels of the AAO module by turning the jog dial to the left/right. Selected channels are highlighted in blue.
- ▶ Call up the level adjustment by pressing the jog dial. The outer ring of the channel is highlighted in blue.

i If you call up the level adjustment of all channels, the smallest value adjusted for a channel is displayed in the menu selection. By turning the jog dial, you can adjust the level of all channels to the value displayed in the menu selection.

- ▶ Adjust the level.
The setting becomes effective immediately.
- ▶ Press the jog dial to confirm your setting and to return to the channel selection.
- ▶ Adjust the level of further channels.
- ▶ Press the **save** button **16**. Your settings are stored and the receiver then switches to the main menu.

To change to the main menu without storing your settings:

- ▶ Press the **esc** button **22**.

“Word clock” – Configuring the word clock

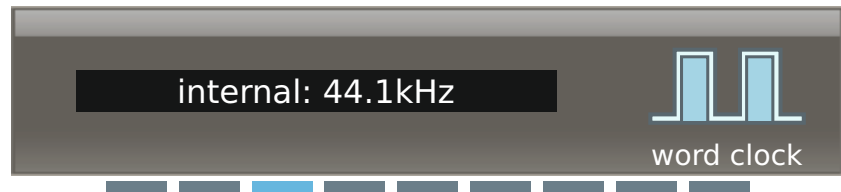

Via the “word clock” menu item, you can ...

- switch between the following word clock signals:
 - internally generated word clock signal
 - external word clock signal
 - word clock signal of a built-in MAN card
- adjust the sampling rate (44.1 kHz, 48.0 kHz, 88.2 kHz or 96.0 kHz) with which – with an internally generated word clock signal – analog signals are digitalized and output at the XLR-3 sockets ⑪.

“Cable attn” – Displaying the cable attenuation and automatically compensating for it

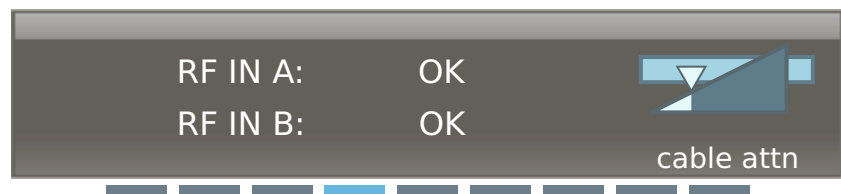

The EM 9046 receiver measures the cable attenuation between the antenna boosters and the antenna inputs ⑮ and ⑯ and automatically compensates for it:

- during the boot routine
- if both antenna boosters are connected or replaced
If only one antenna booster is connected or replaced, the cable attenuation will not be measured.

To manually initiate the compensation of the cable attenuation:

- ▶ In “sys” operating mode, turn the jog dial until “cable attn” appears.
- ▶ Press the jog dial.
“Press SAVE to calibrate” is displayed on the display panel.
- ▶ Press the **Save** button.
During the measurement, the channel status display ⑪ displays “Calibrating” for each channel. The receiver is muted for approx. 10 seconds. Then the result of the measurement is displayed as follows:

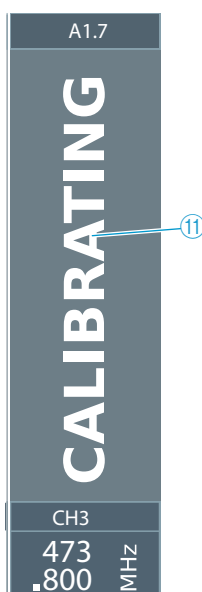

| Display | Status of the cable attenuation |
|------------|---|
| "ok" | The cable attenuation has been measured and is automatically compensated for. |
| "Too high" | The cable attenuation has been measured and is too high. It cannot be automatically compensated for. The reception of weaker signals is compromised. ▶ Check and optimize the installation between the EM 9046 and the antenna boosters. |



Always use GZL 9000 system cables to obtain optimum attenuation values.

"Load config" – Loading a configuration

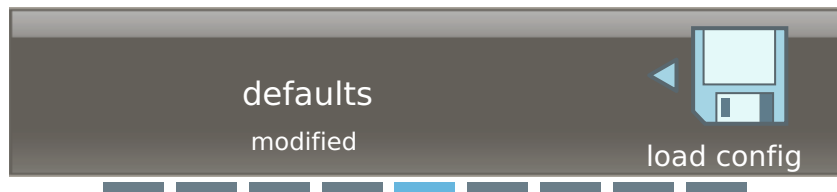

The "load config" menu item allows you to load up to 10 saved settings of your system configuration (see also the "save config" menu item).

In addition, you can ...

- load the last configuration saved ("last").
- load the default configuration ("defaults"). In this case, the settings of the menu items mentioned in the section "save config" are reset to their factory defaults.

"Save config" – Saving a configuration

Via the "save config" menu item, you can save your system configuration on up to 10 storage memories.

The settings of the following menu items are saved:

| Menu | Menu item | Page |
|----------------------------------|----------------------------------|------|
| Main menu "System setup" | Output level | 63 |
| | Word clock | 64 |
| | Network name of the network | 66 |
| | Network IP settings | 66 |
| | Brightness | 66 |
| Extended menu "Service setup" | Date & time selected time zone | 69 |

| Menu | Menu item | Page |
|------------------------------|------------|------|
| Main menu "Channel setup" | Frequency | 77 |
| | Name | 78 |
| | Cmd mode | 78 |
| | Encryption | 79 |
| | Gain | 82 |
| | Low cut | 82 |
| | Display | 83 |
| | Lock | 83 |
| | Cable | 83 |

The following settings/values are **not** saved:

- time and date settings of the "Date & time" menu item (see page 69) and
- operating hours (displayable via the "op hours" menu item, see page 69).

"Network" – Configuring the network

The screenshot shows the 'Network' configuration screen. At the top, there are two input fields: 'Name' with the value 'EM 9046' and 'IPv4 address' with the value '169.254.92.238'. To the right of these fields is a 'network' icon. Below this, a detailed view shows the following settings:

- Slot analog: EM 9046
- IPv4 address: auto (192.254.95.238)
- subnet mask: auto (255.255.0.0)
- gateway: auto (0.0.0.0)
- LAN UP: 00:1b:66:fe:c4:42
- LAN DOWN: aa:1b:66:fe:c4:43

Via the "Network" menu item, you can assign the receiver a network name and select whether to obtain an IP address automatically or to enter the IP address manually. In addition, this menu item displays the unchangeable MAC addresses of the network interfaces of your receiver.

"Brightness" – Adjusting the brightness

The screenshot shows the 'Brightness' menu. It features a horizontal bar with five white squares, indicating the current brightness level. To the right of this bar is a gear icon. The word 'brightness' is displayed at the bottom right of the screen.

Via the "Brightness" menu item, you can adjust the brightness in 8 steps. This also adjusts the brightness of the LED lighting.

“Screensaver”





The “Screensaver” menu item adjusts the “Brightness” to the lowest (menu-selectable) value, independent of the user-set “Brightness” value.

The “Screensaver” is activated after 30 minutes if the following conditions are met:

- The “Screensaver” menu item is set to **ON**.
- No entry via button or jog dial for 30 minutes.
- No RXD card connected to a transmitter for 30 minutes.

The described “Screensaver” state is deactivated and the 30 minutes timer is restarted if:

- a button is pressed (the function of the button is also performed)
- the jog dial is turned or pressed (the function of the jog dial is also performed)
- the Standby button  ③ is pressed
- a transmitter is switched on and its signal is received by an RXD card. The timer remains deactivated as long as the RXD card is connected to the transmitter
- an error message is displayed over the whole screen. The timer remains deactivated until the error message is confirmed and is quit using the **esc** button 

The described screensaver state remains unchanged if:

- the headphone volume control is turned, i.e. the “Screensaver” remains active and the screen will not brighten since the headphone volume control is considered a pure volume control not related to the screen

The “Screensaver” timer is inactive as long as one of the following conditions is met:

- The “Screensaver” menu item is set to **OFF**.
- An RXD card is connected to a transmitter.
- An error message is displayed over the whole screen.

Extended menu “Service setup”

To get into the extended menu “Service setup”:

- ▶ In “sys” operating mode, turn the jog dial until “Service setup” appears.
- ▶ Press the jog dial.
The extended menu “Service setup” appears.

To change from the extended menu back to the main menu:

- ▶ Turn the jog dial until “System setup” appears.
- ▶ Press the jog dial.
You are back to the main menu “System setup” of the “sys” operating mode.

In the extended menu, you can adjust the following settings:

“Factory reset” – Resetting the receiver to the factory defaults

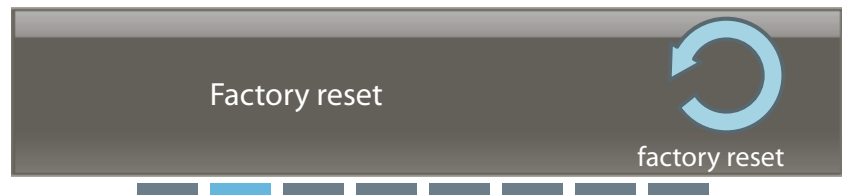

Via the “factory reset” menu item, you can reset your receiver to the factory default settings. To do so, follow the prompt on the main screen to press the **save** button **16** for 5 seconds.

The following menu items are reset to their factory default settings:

| Menu | Menu item | Factory default setting | Page |
|-------------------------------------|-------------------------------------|--|------|
| Main menu “System setup” | Output level | 0 dB | 63 |
| | Word clock | 96 kHz | 64 |
| | Network name of the network | EM9046_1 | 66 |
| | Network IP settings | Auto | 66 |
| | Brightness | Medium level | 66 |
| Extended menu “Service setup” | Date & time selected time zone | Amsterdam, Berlin, Bern, Rome, Stockholm, Vienna | 69 |
| Main menu “Channel setup” | Frequency | Without connected boosters: 470.000 MHz With connected boosters: A1.1–A1.8 or B1.1–B1.8, allocated to the channels 1–8 | 77 |
| | Name | Ch1–Ch6 | 78 |
| | Cmd mode | Toggle | 78 |
| | Encryption | Off | 79 |
| | Gain | 0 dB | 82 |
| | Low cut | 30 Hz | 82 |
| | Display | Name | 83 |
| | Lock | Off | 83 |
| Cable | Line | 83 | |

- In addition, all configurations saved in the “save config” menu item are deleted.
- The event log is deleted and then the deleting itself is logged.

The following settings/values are **not** deleted:

- time and date settings of the “Date & time” menu item (see page 69) and
- operating hours (displayable in the “op hours” menu item, see page 69).

“Date & time” – Adjusting the date and time

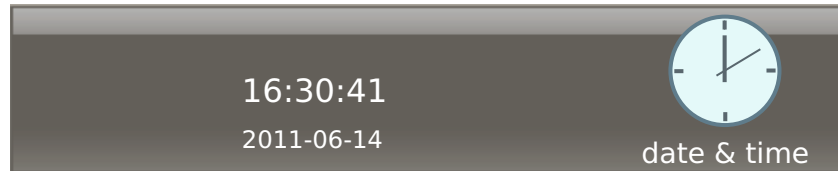

Via the “Date & time” menu item, you can select your time zone and then adjust the date and time:

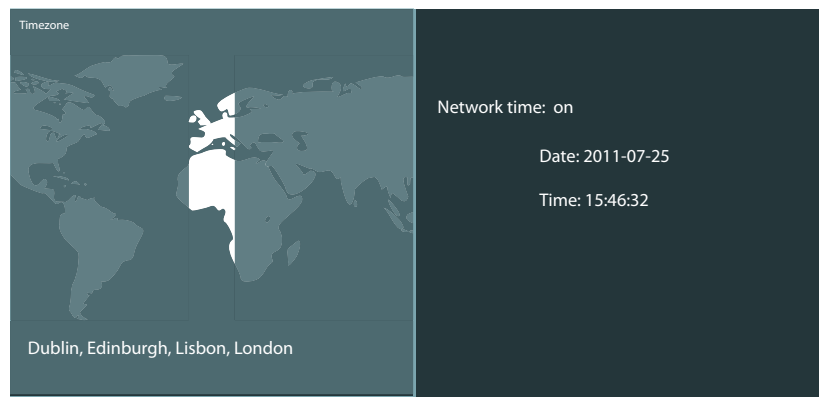

“Op hours” – Displaying the operating hours



The “op hours” menu item displays the operating hours of the EM 9046.

“Logfile” – Displaying the event logs

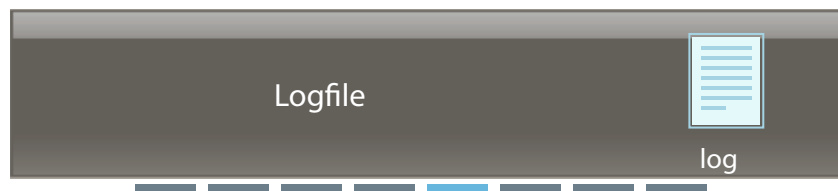

The EM 9046 receiver logs user actions and erroneous and suspicious system states. The log records the last 1000 events.

The log entries contain the following information:

- Time stamp (format “YYYY-MM-DD hh:mm:ss”)
- Degree of severity (“info”, “warning” or “error”)
- Message

The following events are logged:

- System starts and (controlled) stops
- System error messages (error screens)
- Channel warnings
- Each storing of settings with specification of the changed values
- Each modification of values via the WSM software
- Each synchronization with a transmitter
- Software updates

“System check” – Displaying current error and warning messages



Via the “system check” menu item, you can display current error and warning messages.

If, for example, a booster is removed during operation or if it is missing when the EM 9046 is started, the following warning message appears:

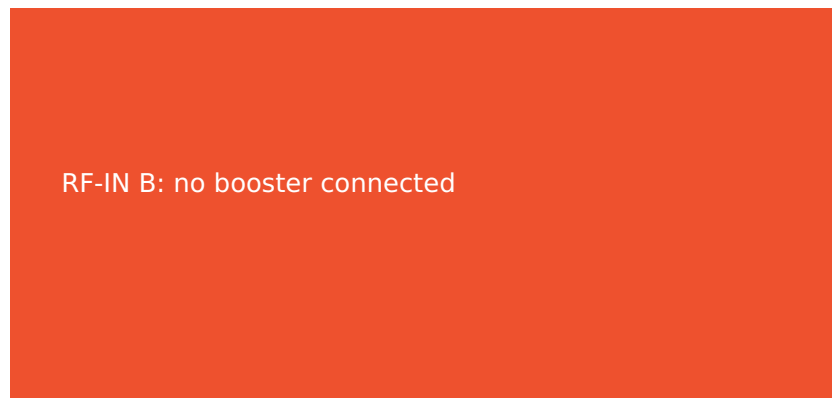

If you hide this warning message by pressing the **esc** button , the missing booster continues to be displayed in the “system check” menu item.

The menu selection changes its appearance when a warning message is present:

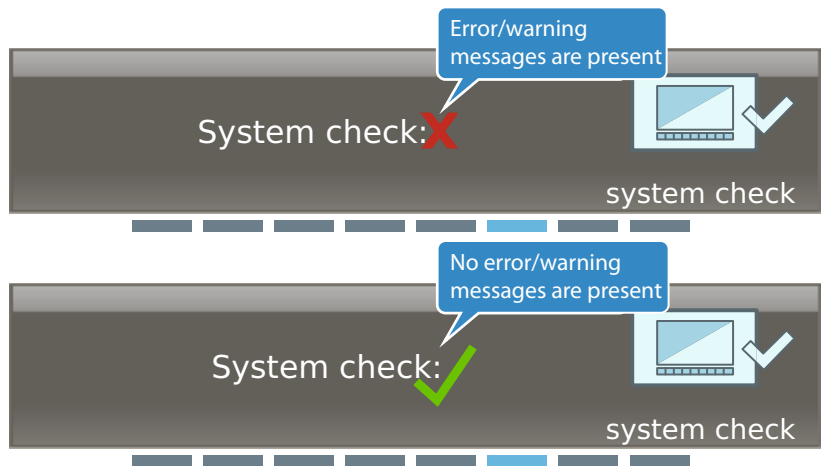

Call up this menu item to get detailed information on error and warning messages.

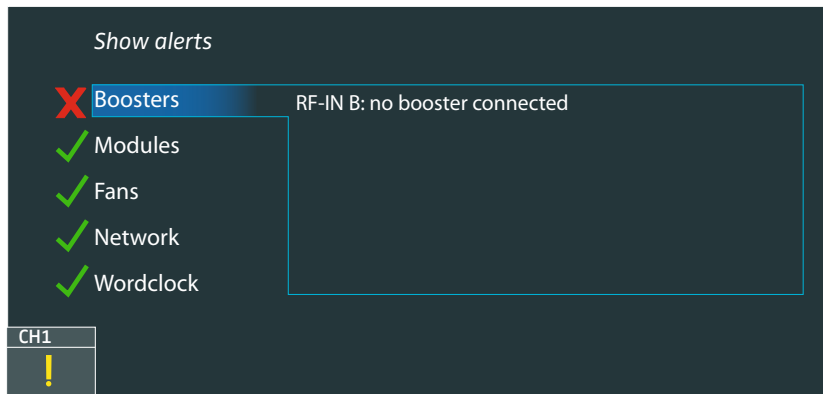

If you call up the first menu entry “[Show alerts](#)”, the warning message is displayed again and the display panel is highlighted in orange.

“Hw setup” – Displaying the EM 9046’s hardware configuration and confirming a modified configuration

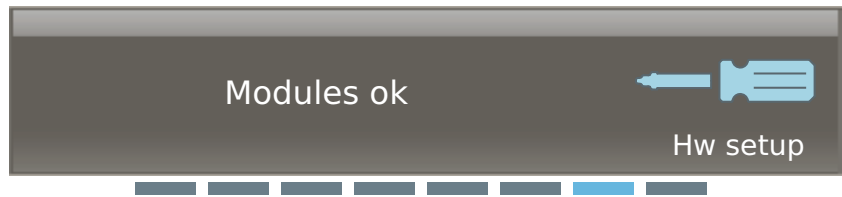

While the operating system of the EM 9046 starts up, it checks the receiver’s hardware configuration for modifications. Modifications of the hardware configuration are indicated by warning messages.

If, for example, a DAO module has been removed, the following warning message appears:

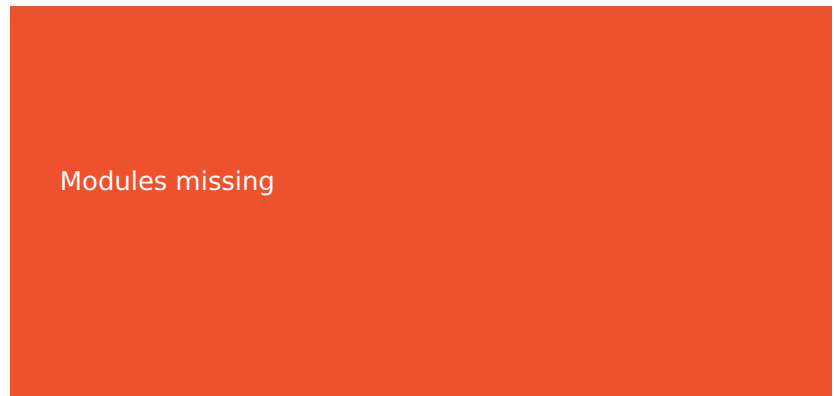

If you hide this warning message by pressing the **esc** button , the missing module is displayed in the “hw setup” menu item with the status “missing”:



| Hardware setup | | | Press SET to confirm |
|----------------|-------------|---------|----------------------|
| Slot | Module type | State | |
| RX1 | EM 9046 DRX | ok | |
| RX2 | EM 9046 DRX | ok | |
| RX3 | EM 9046 DRX | ok | |
| RX4 | EM 9046 DRX | ok | |
| RX5 | EM 9046 DRX | ok | |
| RX6 | EM 9046 DRX | ok | |
| RX7 | EM 9046 DRX | ok | |
| RX8 | EM 9046 DRX | ok | |
| OUT1 | EM 9046 AAO | ok | |
| OUT2 | EM 9046 DAO | missing | |

If you have extended the EM 9046's hardware configuration, this is displayed in the "hw setup" menu item with the status "added":

| Slot | Module Type | State |
|------|-------------|-------|
| RX1 | EM 9046 DRX | ok |
| RX2 | EM 9046 DRX | ok |
| RX3 | EM 9046 DRX | ok |
| RX4 | EM 9046 DRX | ok |
| RX5 | EM 9046 DRX | ok |
| RX6 | EM 9046 DRX | ok |
| RX7 | EM 9046 DRX | ok |
| RX8 | EM 9046 DRX | ok |
| OUT1 | EM 9046 AAO | ok |
| OUT2 | EM 9046 DAO | added |

In both cases, the "Press SET to confirm" button is highlighted in blue.

In the "hw setup" menu item, you confirm modifications as follows:

- ▶ Press the jog dial.
The "Press SET to confirm" button is framed in blue and "Press save to confirm hw setup" appears in the menu selection.
- ▶ Press the  save button .

"Firmware" – Displaying the hardware versions/firmware versions and updating the firmware

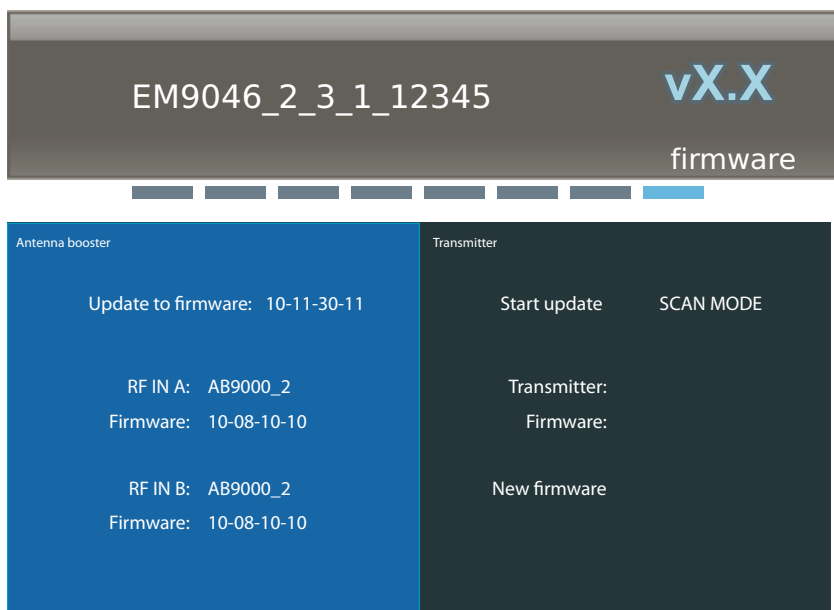

If you update the EM 9046 receiver's firmware using the WSM software, the current firmware versions of the 9000 series boosters and transmitters are also stored on the receiver.

Via the "Firmware" menu item, you can display the firmware versions of the receiver, the boosters and the transmitters and update the firmware of the boosters and the transmitters.

The currently installed firmware version of the EM 9046 is displayed in the menu selection (see above).

The currently installed firmware version and the installable firmware (“Update to Firmware”) of connected boosters/transmitters are displayed in the “Antenna Booster” area of the main screen.

To update the firmware of the boosters:

- ▶ Using the jog dial, select the “Antenna Booster” area of the main screen. The “Antenna Booster” area is highlighted in blue.
- ▶ Press the jog dial. The firmware is updated. The update process can take up to 40 seconds. Do not interrupt the transmission during the update process.

To read out and, if necessary, update the firmware of your transmitters:

- ▶ Make sure the accupacks of your transmitters are fully charged.
- ▶ Using the jog dial, select the “Transmitter” area of the main screen. The “Transmitter” area is highlighted in blue.
- ▶ Press the jog dial. The infra-red interface ⑭ is activated and flashes blue, the “Start update” menu entry is highlighted in blue:

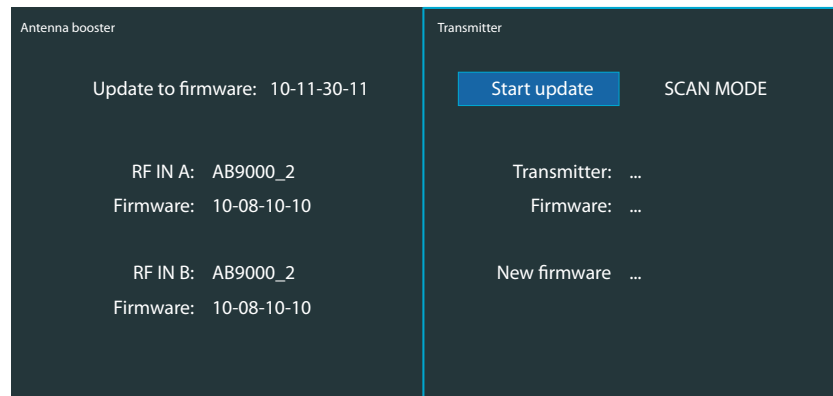

- ▶ Place the infra-red interface of a transmitter in front of the infra-red interface ⑭ of the EM 9046. The currently installed firmware version of the transmitter and the installable firmware are displayed.
- ▶ Press the jog dial.

First, the transmitter is read out and “Scanning transmitter ...” appears in the menu selection of the receiver’s display panel. Then, the transmitter firmware is updated: the infra-red interface flashes faster, “Updating transmitter ... (ca. xx s)” appears in the menu selection of the receiver’s display panel together with a time specification in seconds. Do not interrupt the transmission during the update process.



During the update, the following icon appears on the display panel of your transmitter:



If the firmware update was successful, this icon disappears and “Transmitter fw update successful” appears in the menu selection of the receiver’s display panel.

If the update fails, the following icon appears on the display panel of your transmitter:



In addition, the error message “Error: Transmitter fw update failed” briefly appears in the menu selection of the receiver’s display panel.

In this case, place the infra-red interface of the transmitter in front of the infra-red interface ⑭ of the EM 9046 and update the transmitter firmware without interrupting the infra-red transmission.

To read out and, if necessary, update the firmware of additional transmitters:

- ▶ Place the infra-red interface of the transmitters in front of the infra-red interface ⑭ of the EM 9046, one after the other, and proceed as described above.

To return to the main menu:

- ▶ Press the **esc** button ②.

“Legal”

Here license and copyright information on the software used in the EM 9046 are shown. The license and copyright information are shown in the display of the EM 9046.

Source code







You can request the source code of the software free of charge by sending an e-mail to **opensource@sennheiser.com**, in so far as the respective license information grants the provision of the source code.







“ch” operating mode – Configuring channels

In “ch” operating mode, you can configure channels. Some of the settings that can be made can be synchronized via infra-red between the receiver and the transmitters. These settings are marked with a ✓ in the **sync** column (see also next page).

In “ch” operating mode, you can also select channels for headphone monitoring. To do so, proceed as described on page 84.

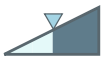
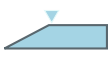
Overview of the “ch” menu

| Main menu “Channel setup” | | | sync | Page |
|---|-------------------|---|------|------|
|  | Frequency | Selects a frequency preset or sets the frequency manually | ✓ | 77 |
|  | Name | Enters a channel name | ✓ | 78 |
|  | CMD mode | Configures audio and command outputs | | 78 |
|  | Ch standby | Mutes the channels | | 79 |
|  | Encryption | Binds the audio signal to the receiver and protects against eavesdropping | ✓ | 79 |
|  | RF level rec | Records the antenna signals and the diversity evaluation | | 80 |
|  | Transmitter setup | Calls up the extended menu “Transmitter setup” | | – |

| Extended menu “Transmitter setup” | | | sync | Page |
|---|---------------|--|------|------|
|  | Channel setup | Calls up the main menu “Channel setup” | | – |
|  | RFmode | Adjusts the transmission mode | ✓ | 82 |
|  | Gain | Adjusts the transmitter’s input gain | ✓ | 82 |
|  | Low cut | Sets the transmitter’s low-cut filter | ✓ | 82 |
|  | Display | Selects the transmitter’s standard display | ✓ | 83 |
|  | Lock | Activates/deactivates the transmitter’s lock mode | ✓ | 83 |
|  | AF source | Displays the microphone head (SKM)/audio source and cable emulation (SK) | | 83 |
|  | Cable | Emulates different instrument cable lengths (SK) | ✓ | 83 |

To synchronize the settings with your transmitters via infra-red:

- ▶ Select one of the channels 1–8.
- ▶ Switch on the transmitter to which you want to assign this channel.
- ▶ Press the **syn** button ⑳ on the EM 9046.
The receiver switches to synchronization mode and the **syn** LED ㉑ flashes.
- ▶ Place the transmitter's infra-red interface in front of the infra-red interface ⑭ of the receiver. Maintain a distance of approx. 10–20 cm between the infra-red interfaces.
The transmitter and receiver are synchronized:
 - After pressing the **syn** button ⑳, the receiver's infra-red interface searches for a suitable transmitter infra-red signal for 12 seconds.
 - You can interrupt the synchronization at any time by pressing the **syn** button ⑳ again.
 - If a problem occurs during the synchronization process, read the chapter "If a problem occurs ..." on page 110.
- ▶ Repeat the above steps for the remaining transmitters.

Main menu "Channel setup"

To get into the main menu:

- ▶ Select the "ch" operating mode.
- ▶ Select one or several channels (see page 52).
- ▶ Call up the menu items described in the following and adjust your settings.

i If no channel is selected, "Please select Channel" is displayed in the menu selection.

- ▶ Press the **save** button to store your settings.
- ▶ Synchronize your settings via infra-red (see page 77).

"Frequency" – Selecting a frequency preset or setting a frequency manually **syn**

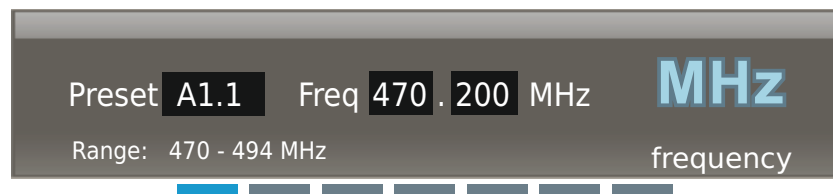

Via the "Frequency" menu item, you can select a frequency preset for the active booster frequency range or set the frequency manually. In the above diagram, range "A1" is active. The frequency range is from "470-494 MHz". For information on how to activate a booster frequency range, refer to page 59.

- ▶ Either select a frequency preset ("A1.1" ... "A1.40" in the above diagram) or set the frequency manually ("U"). If you set the frequency manually, make sure to set a frequency within the current 24 MHz booster frequency range and maintain a frequency spacing of 600 kHz to avoid intermodulation interference.

If you manually set the frequency to a value outside the current 24 MHz booster frequency range and confirm your setting by pressing the **save** button 16, the following error message appears:

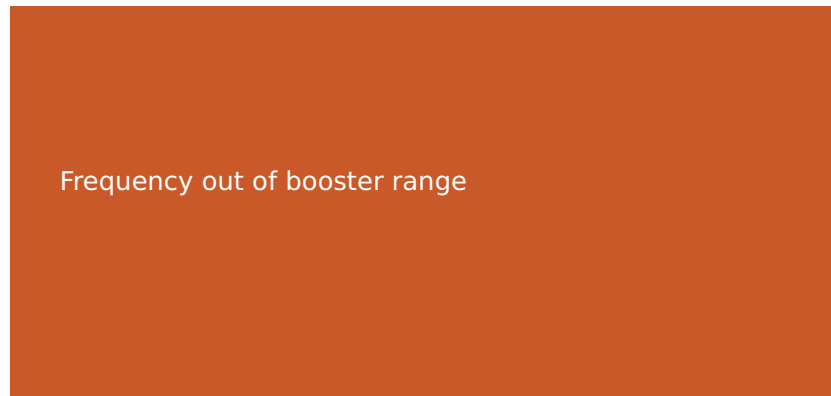

"Name" – Entering a channel name 



Via the **"Name"** menu item, you can enter freely selectable names. The channel name can consist of up to 8 characters from the following character set:

```
'+' ';' '-' '|' '/' '0' '1' '2' '3' '4' '5' '6' '7' '8' '9' '*' ';' '<' '=' '>'
'space' '#' 'A' 'B' 'C' 'D' 'E' 'F' 'G' 'H' 'I' 'J' 'K' 'L' 'M' 'N' 'O' 'P'
'Q' 'R' 'S' 'T' 'U' 'V' 'W' 'X' 'Y' 'Z'
```

"Cmd mode" – Configuring the audio and command outputs

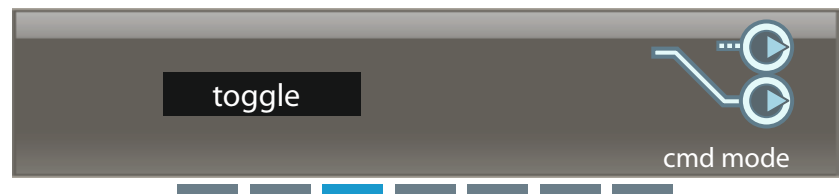

You can use the command function e.g. for stage directions.

For this, you require the SKM 9000 COM radio microphone or the SK 9000 bodypack transmitter together with the KA 9000 COM command adapter.

By pressing the COMMAND button on the SKM 9000 COM or KA 9000 COM, you can influence the routing of the audio signal of the receiver's XLR-3 sockets 13 and sub-D socket 14.

The following settings are possible:

| Setting | Effect |
|----------|--|
| "on" | The transmitter's audio signal is output via both its audio channel (XLR-3 sockets 13 1 ... 8) and the corresponding channel of the sub-D socket 14. Pressing the COMMAND button on the SKM 9000 COM or KA 9000 COM has no effect. |
| "add" | The transmitter's audio signal is output via its audio channel (XLR-3 sockets 13 1 ... 8). Pressing the COMMAND button on the SKM 9000 COM or KA 9000 COM has the effect that the audio signal is additionally output via the corresponding channel of the sub-D socket 14. |
| "mute" | The transmitter's audio signal is output via both its audio channel (XLR-3 sockets 13 1 ... 8) and the corresponding channel of the sub-D socket 14. Pressing the COMMAND button on the SKM 9000 COM or KA 9000 COM mutes both the audio channel (XLR-3 sockets 13 1 ... 8) and the corresponding channel of the sub-D socket 14. |
| "toggle" | The transmitter's audio signal is output via either its audio channel (XLR-3 socket 13 1 ... 8) or the corresponding channel of the sub-D socket 14. Pressing the COMMAND button on the SKM 9000 COM or KA 9000 COM switches between the two channels. |

"Ch standby" – Muting channels

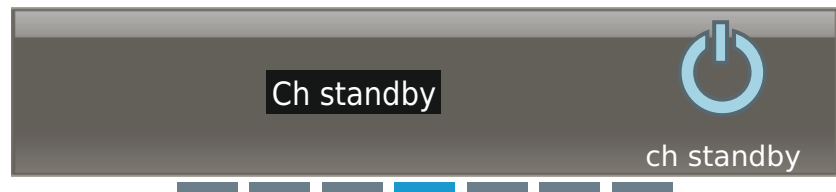

The "Ch standby" menu item allows you to mute selected channels. When muted, the channels do not output any audio signal, neither via the Analog Audio Out (AAO)/Digital Audio Out (DAO) modules, nor via headphones.

"Encryption" – Binding the audio signal to the EM 9046 receiver

syn▶

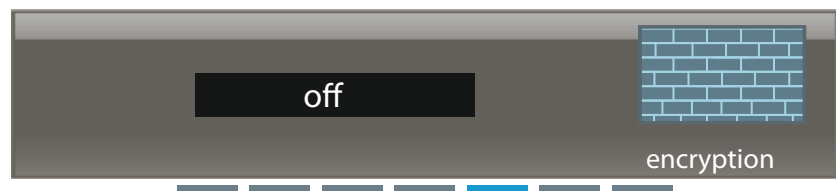

Via the "Encryption" menu item, you can protect the audio signal against eavesdropping from other receivers by binding the transmitters to the EM 9046 receiver. In this case, other receivers can receive the RF signal of the transmitters but cannot evaluate the audio signal.

To protect the audio signal against eavesdropping from other receivers:

- ▶ In the “Encryption” menu item, select “On” and press the **Save** button to store your setting.
- ▶ Synchronize the setting via infra-red (see page 77).

“RF level recorder” – Recording the antenna signals and the diversity evaluation (walk test)

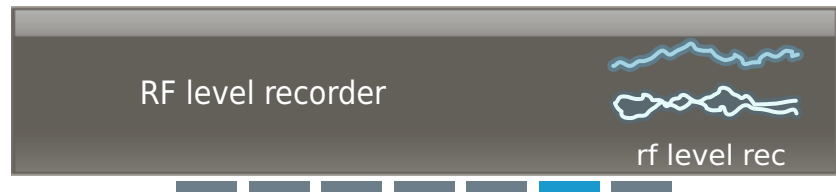

The “RF level recorder” menu item allows you to record the antenna signals and the diversity evaluation (walk test) in order to check the reception quality of your transmission link within the operating environment.

- ▶ Before performing the walk test, switch **on** all possible sources of interference (e.g. light sources, intercom links, video walls) and all other transmission links.
- ▶ Switch on all transmitters that you want to use for the walk test.
- ▶ Change to the “ch” operating mode on the EM 9046.
- ▶ Establish transmission links between the channels of the EM 9046 and the transmitters.
- ▶ Select a channel and call up the “RF level recorder” menu item.
- ▶ Start the walk test by pressing the jog dial.
 - You can cancel the walk test at any time by pressing the **Save** button **16** or the **esc** button **22** on the EM 9046. In doing so, the recorded data is deleted.
 - Use one or several transmitters to walk the operating environment. While performing the walk test, the diversity evaluation and the antenna signals for all channels are recorded. You can switch between the channels by pressing one of the channel **1** to **8** buttons **23**.
 - If you are using an SKM 9000 COM or an SK 9000 together with the KA 9000 COM command adapter, you can set markers by pressing the **COMMAND** button at critical locations.
 - You can additionally activate the 1 kHz test tone on your transmitter (see page 90 and page 99) and monitor the signal quality of the test tone via loudspeakers while walking the operating environment.
 - If you perform the walk test as a pair, the second person can monitor the signal quality of the test tone by means of headphones connected to the EM 9046.

► Assess the result of the walk test:

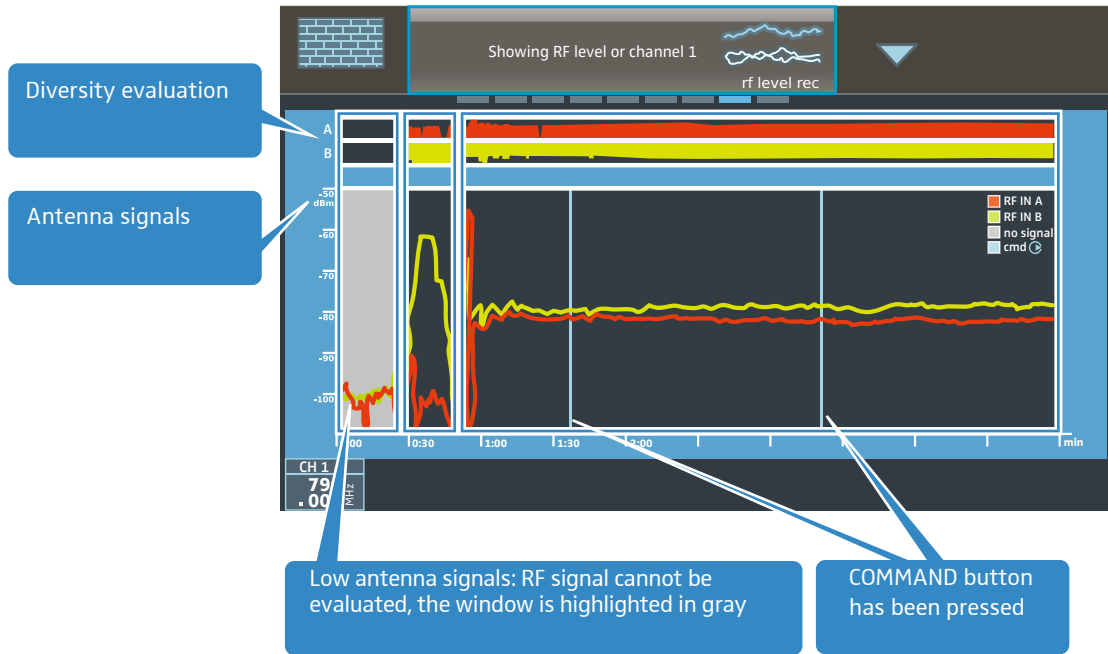

Interference due to extraneous RF signals and low antenna signals can impede the evaluation of a transmitter's RF signal. In this case, the window displaying the recorded antenna signals is highlighted in light gray.

- Reposition the antennas to minimize interference and to optimize the reception of transmission signals.
- Call up the "RF level recorder" menu item again and repeat the walk test.

Extended menu "Transmitter setup"

Via the extended menu "Transmitter setup", you can adjust the transmitter settings and then synchronize them via infra-red.

The menu items allow you to adjust settings over the entire value range of the Digital 9000 transmitters. Please note, however, that the actual values are determined by the hardware configuration of your transmitters (frequency range, type of microphone head being used (SKM), type of Sennheiser microphone or cable being used (SK), etc.).

If you adjust settings that are not supported by the transmitters' current hardware configuration, the value actually adopted by the transmitter is written back to the menu item of the extended menu "Transmitter setup".

If you transfer a frequency range that is not supported by your transmitter, "Sync Fail" is displayed in the menu selection of the receiver's display panel.

Modifications made via the "Transmitter setup" menu item of the EM 9046 must be synchronized via infra-red.

Modifications made directly on the transmitters have direct effect on the menu items of the extended menu "Transmitter setup" of the EM 9046.

For details on the adjustment ranges of your transmitters, refer to the description of the transmitters' operating menu.

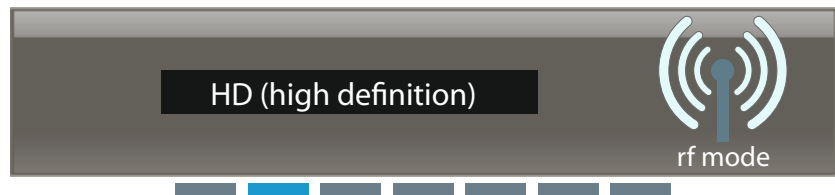
“RF mode” – Adjusting the transmission mode 

The “RF mode” menu item allows you to adjust the transmission mode:

“HD (High Definition)”: Transmission of an audio signal without audio data compression. As a result, the audio signal remains pure and unadulterated. In “HD” transmission mode, the range can be restricted compared to “LR” transmission mode.

“LR (Long Range)”: Transmission of an audio signal whose bit rate is reduced – before transmission – by an audio data compression technique (SeDAC, Sennheiser Digital Audio Codec). This compression technique provides excellent audio quality and a large transmission range. The sensitivity to interference is reduced compared to “HD” transmission mode.

The selection of the transmission mode depends on the result of the frequency scan. For more information, refer to the chapter “Frequency scan” – Performing a frequency scan of all 8 frequency ranges from page 56 onwards.

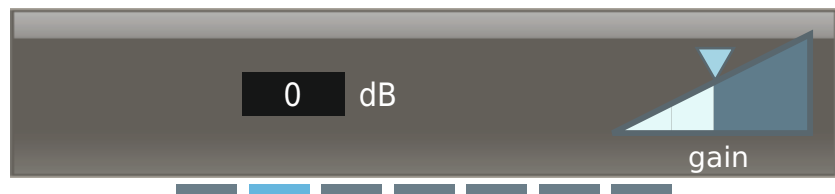
“Gain” – Adjusting the input gain 

The “Gain” menu item allows you to adjust the input gain of selected channels, independent of whether the transmitter to be synchronized supports the adjusted value. The factory preset is –6 dB. The adjustment range is from –6 dB to +60 dB.

After synchronization with the transmitter, the value actually adopted by the transmitter is written back to the menu item.

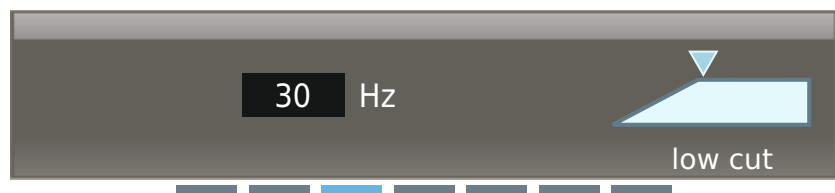

If you select “line” in the “Cable” menu item (see page 83), the input gain in the “Gain” menu item is set to the fixed value of –6 dB.

“Low cut” – Setting the low-cut filter 

Via the “Low cut” menu item, you can set the transmitter’s low-cut filter. Possible settings: 30 Hz to 120 Hz.

You can adjust this setting independent of whether the transmitter to be synchronized supports the adjusted value.

After synchronization with the transmitter, the value actually adopted by the transmitter is written back to the menu item.

“Display” – Selecting the standard display for the transmitters

syn ▶

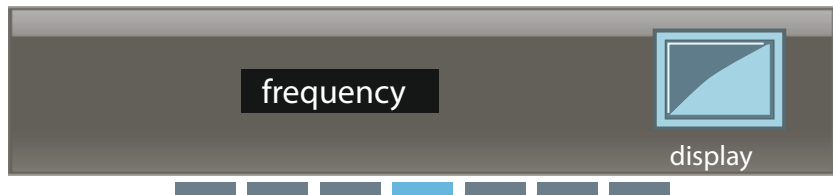

The “Display” menu item allows you to activate one out of 3 standard displays: “Name”, “Preset” or “Frequency”. The “Name” standard display is factory preset.

“Lock” – Activating/deactivating the lock mode

syn ▶

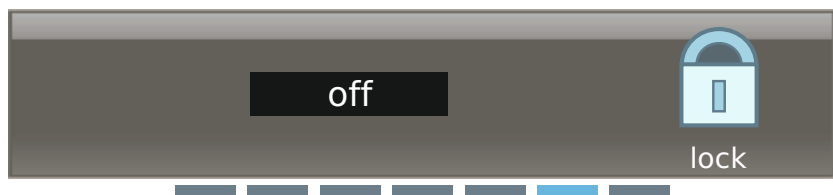

Via the “Lock” menu item, you can activate or deactivate the lock mode for your transmitters.

“AF source” – Displaying the audio source

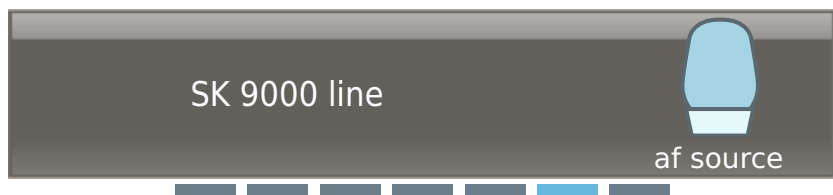

The “AF source” menu item allows you to display the type of microphone head being used (SKM), the type of audio source being used (SK: “micro”, “line”) and the emulation of instrument cables (SK: “type1”, “type2”, “type3”). This information is transmitted along with the SKM/SK 9000’s RF signal to the receiver.

The information is displayed until the transmitter is switched off or the carrier frequency is changed. When the SKM/SK transmits again on the carrier frequency, the corresponding microphone head/audio source is displayed once again in the menu item.

If a transmitter is switched off or transmits on a different carrier frequency, “No TX detected” is displayed.

“Cable” – Emulating different instrument cable lengths

syn ▶

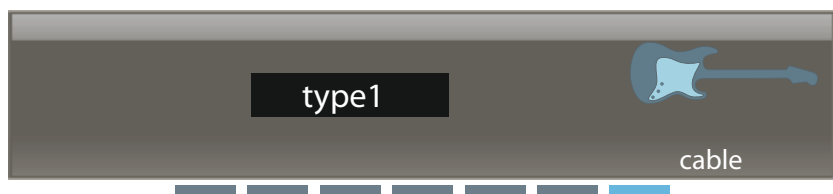

Via the “Cable” menu item, you can emulate the lengths of instrument cables in 3 steps: “type1”, “type2” and “type3”. If you select “line”, no emulation takes place.

“live” operating mode – Using a configured system

In “live” operating mode, you can select channels for headphone monitoring and synchronize the transmitters and the receiver.

To prepare headphone monitoring:

- ▶ Connect headphones as described on page 38.
- ▶ Observe the warnings given there.

To select channels for headphone monitoring:

- ▶ Select a channel by pressing the channel 1–8 button  or press the multiple channel selection button + and then select several channels simultaneously.

 If you have daisy chained several receivers (see “Daisy chaining receivers” on page 35), you can monitor any channel of the daisy chain via any headphone socket in the daisy chain.

In “live” operating mode, you can also activate channels for synchronization:

- ▶ Select a channel by pressing the channel 1–8 button .
- ▶ Proceed as described on page 77.

Channel 1–8 button
and
multiple channel
selection button +

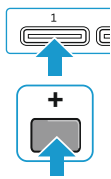

Digital 9000 Using the SKM 9000



| | |
|---|----|
| Using the SKM 9000 | 85 |
| Switching the SKM 9000 on/off | 86 |
| Activating/deactivating the automatic lock mode (Autolock) | 87 |

| | |
|--|----|
| Basic functions of the Sennheiser operating menu . | 88 |
| Overview of the status displays | 88 |
| Overview of the menu items | 89 |

Using the SKM 9000

i Before using your radio microphone, ask the relevant wireless regulatory authority for the exact frequency allocations and apply for an individual license if necessary.

The supplied supplement "Framework requirements and restrictions on frequency usage in Europe" provides an overview of the different European framework requirements and restrictions on frequency usage. If there is no entry in the supplement, ask the relevant wireless regulatory authority for the current rules governing frequency usage.



Switching the SKM 9000 on/off

i When the SKM 9000 is switched on for the first time, it contains the first frequency preset of the transmitter frequency range (e.g. A1.1: 470.200 MHz). Via the "ch" menu of the EM 9046 receiver, set the desired frequency preset and adjust the settings of other menu items and then synchronize the transmitter and the receiver (see page 77). In doing so, all frequency presets of the transmitter frequency range will be transferred to the SKM 9000.

We recommend you to always adjust the transmitter settings via the EM 9046 receiver and then to synchronize the transmitter and the receiver.

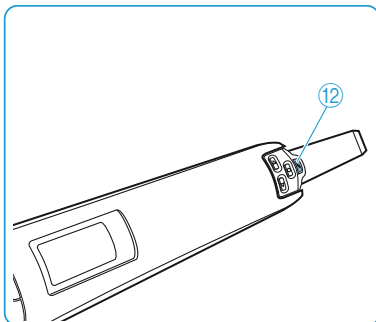
To switch the SKM 9000 **on**:







- ▶ Keep the **ON/OFF** button  **12** pressed until the Sennheiser logo appears on the display panel **5**. The **ON/OFF** button  **12** is backlit in blue and the standard display (here: "Frequency", see page 90) appears on the display panel **5**. The radio microphone transmits an RF signal and the transmission mode display "HD"/"LR" lights up constantly:



To switch the SKM 9000 **off**:

- ▶ Keep the **ON/OFF** button  **12** pressed until the display panel goes off.
- ▶ Remove the accupack/battery pack when the radio microphone will not be used for extended periods of time (see page 40).

To switch the SKM 9000 **off** with **the lock mode activated**:

- ▶ Press the **ON/OFF** button  **12** while the standard display is shown. "LOCK" appears on the display panel because the lock mode is activated.
- ▶ Press the **UP** button  or the **DOWN** button .
- ▶ Press the **SET** button . The lock mode is temporarily deactivated, the lock mode icon **5** flashes.
- ▶ Within the next 2 seconds, press the **ON/OFF** button  **12** and keep it pressed until the display panel goes off.
- ▶ If you switch on the SKM 9000, the lock mode is activated again.

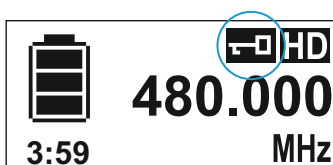



Switching on the SKM 9000 on and checking the set frequency before the RF signal is activated

- ▶ Switch on the SKM 9000 by keeping the ON/OFF button  ⑫ pressed until the "Name" standard display appears.

The RF signal is not activated and the transmission mode display "HD"/"LR" flashes.

If you call up the "Tune" or "Preset" menu item within the next 10 seconds, the RF signal remains deactivated until you exit the menu item. If you do not call up one of the mentioned menu items, the RF signal is automatically activated after 10 seconds.

To check the set frequency/the selected frequency preset:

- ▶ Call up the operating menu and press the UP button /DOWN button  until the "Tune" or "Preset" menu item appears.

The set frequency/the selected frequency preset is displayed.

If the displayed value is the desired one:

- ▶ Wait for 10 seconds to pass.
The RF signal is automatically activated and the transmission mode display "HD"/"LR" lights up constantly.

If the displayed value is **not** the desired one:



- ▶ Call up the "Tune" or "Preset" menu item.
The RF signal remains deactivated until you exit the menu item.
The RF signal remains deactivated until you exit the menu item.
- ▶ Set the frequency ("Tune" menu item) or select a frequency preset ("Preset" menu item) and store your setting.
The RF signal is activated and the radio microphone transmits an RF signal on the set frequency.

Activating/deactivating the automatic lock mode (Autolock)

The radio microphone has an automatic lock mode that can be activated or deactivated via the "LOCK" menu item (see page 87).



To **permanently** activate the automatic lock mode:

- ▶ Call up the "LOCK" menu item and select "On".
 - ▶ Store your setting by pressing the SET button .
- The automatic lock mode is activated and the lock mode icon ⑤ appears on the standard display.



When the automatic lock mode is activated, you can still call up the operating menu, use the UP button /DOWN button  to select menu items (read-only function) and call up the "LOCK" menu item in order to deactivate the automatic lock mode. If, however, you try to call up any other menu item, the following display appears on the display panel:

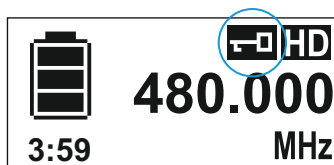

While this display is shown (about 2 seconds), you can temporarily deactivate the lock mode:

- ▶ Press the **UP** button  or the **DOWN** button .
- The following display appears on the display panel:



- ▶ Press the **SET** button .
- The lock mode is temporarily deactivated. The lock mode icon  flashes.
- If you do not press a button, the lock mode is activated again after 2 seconds. The lock mode icon  lights up constantly again.
 - If you continue navigating the operating menu or if you call up a menu item, the lock mode is activated 2 seconds after the last button press.
 - If you exit a called up menu item, the lock mode is activated immediately after exiting the menu item.

To permanently deactivate the automatic lock mode:

- ▶ Call up the "LOCK" menu item and select "Off".
- ▶ Store your setting by pressing the **SET** button .



Basic functions of the Sennheiser operating menu

A special feature of the Sennheiser 9000 series is the straightforward, intuitive operating concept. As a result, you can act quickly and precisely – even in stressful situations, for example on stage or during a live show or presentation.

Calling up and selecting menu items, changing and storing settings, cancelling an entry



UP /**DOWN** 
SET 

- ▶ Press the **SET** button  to call up the operating menu or a menu item, to switch between the selection areas of a menu item and to store your settings.



- ▶ Press the **UP** button /**DOWN** button  to select menu items and to change the settings of a menu item.





ON/OFF 

- ▶ Press the **ON/OFF** button  to exit a menu item without storing your settings or to change from the operating menu to the standard display.











-  When keeping the **UP** button /**DOWN** button  pressed within a menu item, you continuously adjust the next/previous setting of the menu item. Keep the buttons pressed for a longer time to accelerate the speed.

Overview of the status displays

| Status display | Meaning |
|---|-----------------------|
|  | SKM 9000 switches on |
|  | SKM 9000 switches off |

| Status display | Meaning |
|---|--|
|  | <p>BA/B 60 accupack/battery pack: charge status $\leq 100\%$ $\leq 70\%$ $\leq 30\%$ BA 60 accupack: remaining operating time in h:mm</p> |
|  | Accupack/battery pack is completely discharged, transmitter is not operational |
|  | Setting is being stored |
|  | Firmware is being updated |
|  | Firmware update has failed |

Overview of the menu items

| Icon | Name | Function | Page |
|---|-------------|---|------|
|  | Tune | Sets a frequency | 89 |
|  | Preset | Selects a frequency preset | 90 |
|  | Name | Enters a name | 90 |
|  | Gain | Adjusts the input gain | 90 |
|  | Low cut | Sets the low-cut filter | 90 |
|  | RF mode | Adjusts the transmission mode | 90 |
|  | Display | Selects a standard display | 90 |
|  | Lock | Activates/deactivates the lock mode | 90 |
|  | Test tone | Activates the test tone for level matching the system and for the walk test | 90 |
|  | Reset | Resets the factory default settings | 91 |
|  | Information | Displays the firmware version and frequency range | 91 |



“Tune”– Setting a frequency

Via the “Tune” menu item, you can set a frequency. The frequencies are tuneable in 25 kHz steps. If you store your setting, the set frequency is automatically assigned to the user-defined frequency preset “U”. The radio microphone then changes from the currently set frequency preset to the frequency preset “U” and transmits on the set frequency.



“Preset” – Selecting a frequency preset

Via the “Preset” menu item, you can select a frequency preset from the active booster frequency range or the frequency preset “U” (see also the “Tune” menu item).



To activate a different booster frequency range:

- ▶ Proceed as described from page 56 onwards. You first activate the booster frequency range on the EM 9046. If you then synchronize the transmitter and the receiver, the booster frequency range on the transmitter will also be activated.



“Name” – Entering a name

Via the “Name” menu item, you can enter a freely selectable name for the radio microphone. The name can consist of up to 6 characters from the following character set:

```
'+' ','-' '\|' '/' '0' '1' '2' '3' '4' '5' '6' '7' '8' '9' '*' ';' '<' '=' '>'
' ' '#' 'A' 'B' 'C' 'D' 'E' 'F' 'G' 'H' 'I' 'J' 'K' 'L' 'M' 'N' 'O' 'P'
'Q' 'R' 'S' 'T' 'U' 'V' 'W' 'X' 'Y' 'Z'
```



“Gain” – Adjusting the input gain

Via the “Gain” menu item, you can adjust the input gain in 3 dB steps.



The radio microphone automatically detects the type of microphone head being used and changes the adjustment range of the “Gain” menu item accordingly.



“Low cut” – Setting the low-cut filter

Via the “Low cut” menu item, you can set the low-cut filter. Settings: “80 Hz”, “100 Hz”, “120 Hz”.



“RF mode” - Adjusting the transmission mode

The “RF mode” menu item allows you to adjust the transmission mode. Settings: “HD”, “LR”.



“Display” – Selecting a standard display

The “Display” menu item allows you to select one out of 3 standard displays.



“Frequency”

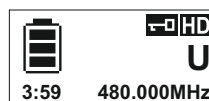

“Preset”



“Name”



“Lock” – Activating/deactivating the lock mode

Via the “Lock” menu item, you can activate or deactivate the lock mode. For more information on how to activate or deactivate the lock mode, refer to page 87.



“Test tone” – Activating the 1 kHz test tone

Via the “Test tone” menu item, you can activate a 1 kHz test tone. This test tone is transmitted instead of the input signal. You can use this function for level matching your system or for the walk test.



“Reset” – Resetting the factory default settings

Via the “Reset” menu item, you can reset the radio microphone to its factory default settings.



“Information” – Displaying the firmware version and frequency range

Via the “Information” menu item, you can display the firmware version and the transmitter’s frequency range.

Digital 9000 Using the SK 9000



| | |
|---|----|
| Using the SK 9000 | 93 |
| Switching the SK 9000 on/off | 94 |
| Activating/deactivating the automatic lock mode (Autolock) | 95 |

| | |
|--|----|
| Basic functions of the Sennheiser operating menu . | 96 |
| Overview of the status displays | 97 |
| Overview of the menu items | 97 |

Using the SK 9000

i Before using your bodypack transmitter, ask the relevant wireless regulatory authority for the exact frequency allocations and apply for an individual license if necessary.

The supplied supplement "Framework requirements and restrictions on frequency usage in Europe" provides an overview of the different European framework requirements and restrictions on frequency usage. If there is no entry in the supplement, ask the relevant wireless regulatory authority for the current rules governing frequency usage.

Switching the SK 9000 on/off

i When the SK 9000 is switched on for the first time, it contains the first frequency preset of the transmitter frequency range (e.g. A1.1: 470.200 MHz). Via the "ch" menu of the EM 9046 receiver, set the desired frequency preset and adjust the settings of other menu items and then synchronize the transmitter and the receiver (see page 77). In doing so, all frequency presets of the transmitter frequency range will be transferred to the SK 9000.

We recommend you to always adjust the transmitter settings via the EM 9046 receiver and then to synchronize the transmitter and the receiver.

To switch the SK 9000 **on**:

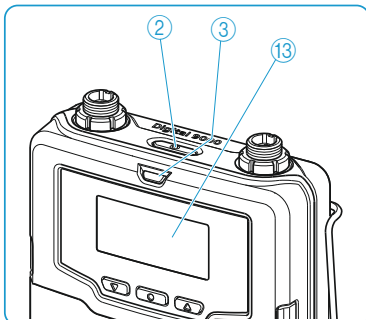





- ▶ Keep the **ON/OFF** button  (2) pressed until the Sennheiser logo appears on the display panel (13). The **ON** LED (3) lights up and the standard display (here: "Frequency", see page 99) appears on the display panel (13). The bodypack transmitter transmits an RF signal and the transmission mode display "HD"/"LR" lights up constantly:



To switch the SK 9000 **off**:

- ▶ Keep the **ON/OFF** button  (2) pressed until the display panel goes off.
- ▶ Remove the accupack/battery pack when the transmitter will not be used for extended periods of time (see page 43).

To switch the SK 9000 **off** with **the lock mode activated**:

- ▶ Press the **ON/OFF** button  (12) while the standard display is shown. "LOCK" appears on the display panel because the lock mode is activated.
- ▶ Press the **UP** button  or the **DOWN** button . "UNLOCK" appears on the display panel.
- ▶ Press the **SET** button . The lock mode is temporarily deactivated, the lock mode icon (5) flashes.
- ▶ Within the next 2 seconds, press the **ON/OFF** button  (12) and keep it pressed until the display panel goes off.
- ▶ If you switch on the SK 9000, the lock mode is activated again.

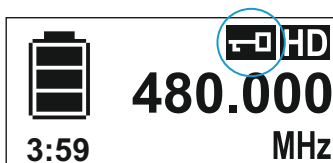



Switching on the SK 9000 on and checking the set frequency before the RF signal is activated

- ▶ Switch on the SK 9000 by keeping the **ON/OFF** button  ② pressed until the "Name" standard display appears.

The RF signal is not activated and the transmission mode display "HD"/"LR" flashes.

If you call up the "Tune" or "Preset" menu item within the next 10 seconds, the RF signal remains deactivated until you exit the menu item. If you do not call up one of the mentioned menu items, the RF signal is automatically activated after 10 seconds.

To check the set frequency/the selected frequency preset:

- ▶ Call up the operating menu and press the **UP** button  /**DOWN** button  until the "Tune" or "Preset" menu item appears.

The set frequency/the selected frequency preset is displayed.

If the displayed value is the desired one:

- ▶ Wait for 10 seconds to pass.

The RF signal is automatically activated and the transmission mode display "HD"/"LR" lights up constantly.

If the displayed value is **not** the desired one:

- ▶ Call up the "Tune" or "Preset" menu item.

The RF signal remains deactivated until you exit the menu item.

- ▶ Set the frequency ("Tune" menu item) or select a frequency preset ("Preset" menu item) and store your setting.

The RF signal is activated and the bodypack transmitter transmits an RF signal on the set frequency.

Activating/deactivating the automatic lock mode (Autolock)



The bodypack transmitter has an automatic lock mode that can be activated or deactivated via the "LOCK" menu item (see page 95).

To **permanently** activate the automatic lock mode:

- ▶ Call up the "LOCK" menu item and select "On".

- ▶ Store your setting by pressing the **SET** button .

The automatic lock mode is activated and the lock mode icon appears on the standard display.

When the automatic lock mode is activated, you can still call up the operating menu, use the **UP** button  /**DOWN** button  to select menu items (read-only function) and call up the "LOCK" menu item in order to deactivate the automatic lock mode. If, however, you try to call up any other menu item, the following display appears on the display panel:



While this display is shown (about 2 seconds), you can temporarily deactivate the lock mode:

- ▶ Press the **UP** button  or the **DOWN** button .
- The following display appears on the display panel:

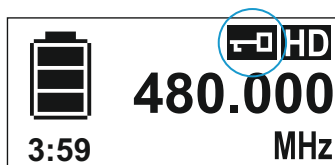

- ▶ Press the **SET** button .

The lock mode is temporarily deactivated. The lock mode icon ⑤ flashes.

- If you do not press a button, the lock mode is activated again after 2 seconds. The lock mode icon ⑤ lights up constantly again.
- If you continue navigating the operating menu or if you call up a menu item, the lock mode is activated 2 seconds after the last button press.
- If you exit a called up menu item, the lock mode is activated immediately after exiting the menu item.

To permanently deactivate the automatic lock mode:

- ▶ Call up the "LOCK" menu item and select "Off".
- ▶ Store your setting by pressing the **SET** button .



Basic functions of the Sennheiser operating menu

A special feature of the Sennheiser 9000 series is the straightforward, intuitive operating concept. As a result, you can act quickly and precisely – even in stressful situations, for example on stage or during a live show or presentation.

Calling up and selecting menu items, changing and storing settings, cancelling an entry

UP  / **DOWN**  /
SET 



- ▶ Press the **SET** button  to call up the operating menu or a menu item, to switch between the selection areas of a menu item and to store your settings.

- ▶ Press the **UP** button  / **DOWN** button  to select menu items and to change the settings of a menu item.







ON/OFF 

- ▶ Press the **ON/OFF** button  to exit a menu item without storing your settings or to change from the operating menu to the standard display.















When keeping the **UP** button  / **DOWN** button  pressed within a menu item, you continuously adjust the next/previous setting of the menu item. Keep the buttons pressed for a longer time to accelerate the speed.

Overview of the status displays

| Status display | Meaning |
|---|--|
|  | SK 9000 switches on |
|  | SK 9000 switches off |
|  | BA/B 61 accupack/battery pack: charge status $\leq 100\% \mid \leq 70\% \mid \leq 30\%$ BA 61 accupack: remaining operating time in h:mm |
|  | Accupack/battery pack is completely discharged, transmitter is not operational |
|  | Setting is being stored |
|  | Firmware is being updated |
|  | Firmware update has failed |

Overview of the menu items

| Icon | Name | Function | Page |
|---|----------------------|---|------|
|  | Tune | Sets a frequency | 98 |
|  | Preset | Selects a frequency preset | 98 |
|  | Name | Enters a name | 98 |
|  | Gain | Adjusts the input gain | 98 |
|  | Low cut ^a | Sets the low-cut filter | 98 |
|  | Cable ^b | Emulates different instrument cable lengths | 99 |
|  | RF mode | Adjusts the transmission mode | 99 |
|  | Display | Selects a standard display | 99 |
|  | Lock | Activates/deactivates the lock mode | 99 |
|  | Test tone | Activates the test tone for level matching the system and for the walk test | 99 |

| Icon | Name | Function | Page |
|---|-------------|---|------|
|  | Reset | Resets the factory default settings | 99 |
|  | Information | Displays the firmware version and frequency range | 99 |

- If you are using the Sennheiser CI 1-4 line/instrument cable, this menu item is hidden
- If you are using the Sennheiser CI 1-4 line/instrument cable, this menu item is shown



“Tune” – Setting a frequency

Via the “Tune” menu item, you can set a frequency. The frequencies are tuneable in 25 kHz steps. If you store your setting, the set frequency is automatically assigned to the user-defined frequency preset “U”. The bodypack transmitter then changes from the currently set frequency preset to the frequency preset “U” and transmits on the set frequency.



“Preset” – Selecting a frequency preset

Via the “Preset” menu item, you can select a frequency preset from the active booster frequency range or the frequency preset “U” (see also the “Tune” menu item).



To activate a different booster frequency range:

- Proceed as described from page 56 onwards. You first activate the booster frequency range on the EM 9046. If you then synchronize the transmitter and the receiver, the booster frequency range on the transmitter will also be activated.



“Name” – Entering a name

Via the “Name” menu item, you can enter a freely selectable name for the bodypack transmitter. The name can consist of up to 6 characters from the following character set:

```
`+``,`-``,`|``,`/``,`0``,`1``,`2``,`3``,`4``,`5``,`6``,`7``,`8``,`9``,`*``,`.``,`<`,`='`,`>`,`space`,`#`,`A`,`B`,`C`,`D`,`E`,`F`,`G`,`H`,`I`,`J`,`K`,`L`,`M`,`N`,`O`,`P`,`Q`,`R`,`S`,`T`,`U`,`V`,`W`,`X`,`Y`,`Z`
```



“Gain” – Adjusting the input gain

Via the “Gain” menu item, you can adjust the input gain in 3 dB steps from -6 to +42 dB.



“Low cut” – Setting the low-cut filter

Via the “Low cut” menu item, you can set the low-cut filter. The bodypack transmitter automatically detects the type of input signal present and changes the settings of the “Low cut” menu item accordingly. If you are using the Sennheiser CI 1-4 line/instrument cable, the “Low cut” menu item is hidden.

| Cable type | Settings |
|---|--|
| Sennheiser microphone cable | “60 Hz”, “80 Hz”, “100 Hz”, “120 Hz” |
| Sennheiser CI 1-4 line/instrument cable | “30 Hz”, the “Low cut” menu item is hidden |



“Cable” – Emulating different instrument cable lengths

Via the “Cable” menu item, you can emulate the lengths of instrument cables in 3 steps. If you are using the Sennheiser CI 1-4 line/Instrument cable, the “Cable” menu item is shown.



“RF mode” - Adjusting the transmission mode

The “RF mode” menu item allows you to adjust the transmission mode. Settings: “HD”, “LR”.



“Display” – Selecting a standard display

The “Display” menu item allows you to select one out of 3 standard displays.



“Frequency”

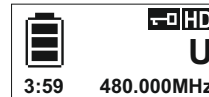

“Preset”



“Name”



“Lock” – Activating/deactivating the lock mode

Via the “Lock” menu item, you can activate or deactivate the lock mode. For more information on how to activate or deactivate the lock mode, refer to page 95.



“Test tone” – Activating the 1 kHz test tone

Via the “Test tone” menu item, you can activate a 1 kHz test tone. This test tone is transmitted instead of the input signal. You can use this function for level matching your system or for the walk test.



“Reset” – Resetting the factory default settings

Via the “Reset” menu item, you can reset the bodypack transmitter to its factory default settings.



“Information” – Displaying the firmware version and frequency range

Via the “Information” menu item, you can display the firmware version and the transmitter frequency range.

Digital 9000 Using the L 60

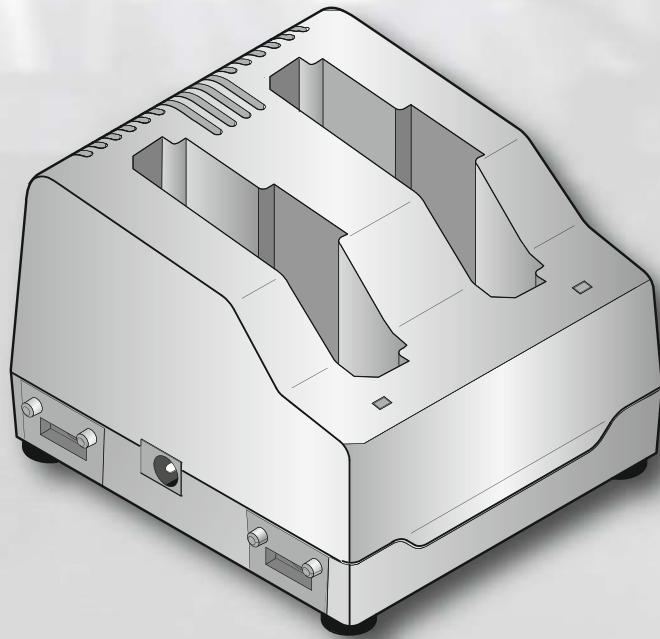

Using the L 60

Connecting the mains unit and switching on the L 60

- ▶ Connect the DC connector of the NT 3-1 mains unit to the DC input socket ② of the L 60 charger.
- ▶ Connect the mains plug (EU, UK or US version) of the mains unit to the mains.
The charger switches on and goes to standby mode.

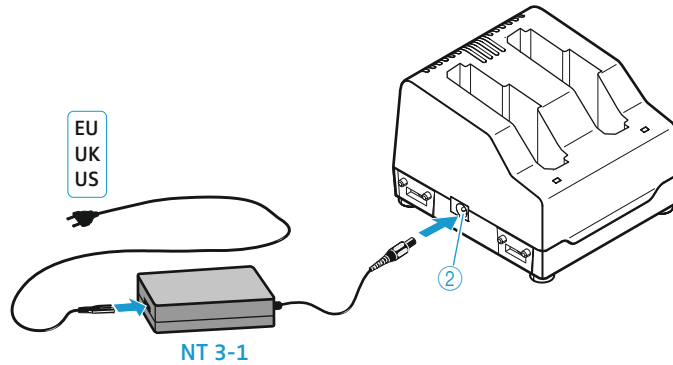

Switching off the L 60 and disconnecting it from the mains

If no accupacks are inserted into the L 60, the charger is in standby mode. To switch off the charger and the NT 3-1 mains unit and to disconnect them from the mains:

- ▶ Unplug the mains plug of the mains unit.

Charging the BA 60/BA 61 accupack

- ▶ Charge the BA 60/BA 61 accupack fully before using it for the first time or if you have not used it for an extended period of time.

The L 60 charger allows you to simultaneously charge ...

... 2 BA 60 or

... 2 BA 61 or

... 1 BA 60 and 1 BA 61.

- ▶ Insert the accupack into one of the charging compartments ③ and make sure that it locks into place with an audible click.

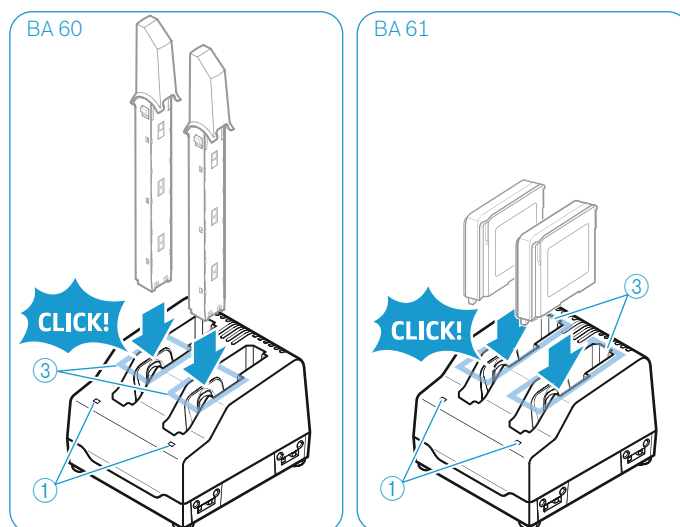

The accupack is being charged. The status LED ① lights up. It is normal for the accupack to get warm during charging.



For an overview of the indications of the status LED ①, refer to page 16.

Charging times

With a completely discharged accupack and at room temperature (approx. 20 °C/68 °F), the charging times are as follows:

| Capacity obtained | Charging time |
|-------------------|-----------------|
| approx. 100 % | approx. 180 min |
| approx. 70 % | approx. 60 min |

However, charging may take longer under the following circumstances:

- The accupack is deep-discharged and first has to be reconditioned by a deep discharge recovery charge.
- The ambient temperature is close to or over 35 °C/95 °F; in order to protect the accupack, the charging power will be reduced until the accupack temperature has dropped to an admissible value.

Charging will be aborted and the status LED ① will start flashing red under the following circumstances:

- The accupack temperature is too low or too high (see page 122); charging starts automatically when the accupack temperature is within the charging temperature range.
- The accupack cannot be fully charged within approx. 8 hours, e.g. due to overaged cells.

Digital 9000
Cleaning and maintenance

Cleaning and maintaining the Digital 9000 system

CAUTION

Liquids can damage the electronics of the products!

Liquids entering the housing of the products can cause a short-circuit and damage the electronics.

- ▶ Keep all liquids away from the products.
- ▶ Do not use any solvents or cleansing agents.

- ▶ Disconnect the products from the mains. Remove the rechargeable batteries or batteries before cleaning.
- ▶ Only use a soft, dry cloth to clean the products.

Cleaning the sound inlet basket of the microphone head

- ▶ Unscrew the upper sound inlet basket from the microphone head by turning it counterclockwise (see diagram).

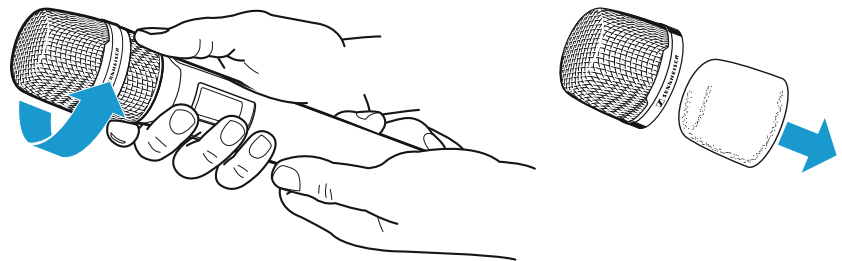

- ▶ Remove the foam insert.

There are two ways to clean the sound inlet basket:

- Use a slightly damp cloth to clean the upper sound inlet basket from the inside and outside.
- Scrub with a brush and rinse with clear water.
- ▶ If necessary, clean the foam insert with a mild detergent or replace the foam insert.
- ▶ Dry the upper sound inlet basket and the foam insert.
- ▶ Reinsert the foam insert.
- ▶ Replace the sound inlet basket on the microphone head and screw it tight.

You should also clean the contacts of the microphone head from time to time:

- ▶ Wipe the contacts of the microphone head with a soft and dry cloth.

Cleaning the contacts of the SK 9000 bodypack transmitter

- ▶ Wipe the contacts with a dry cloth.

Cleaning the L 60 charger

- ▶ Remove all accupacks from the charging compartments.
- ▶ Before cleaning, disconnect the NT 3-1 mains unit from the mains.
- ▶ Use a dry cloth for cleaning.
- ▶ Use a brush or similar to remove dust from the charging compartments.
- ▶ Clean the charging contacts from time to time using e.g. a cotton swab.

Digital 9000
If a problem occurs ...

If a problem occurs ...

EM 9046 receiver

| Problem | Possible cause | Possible solution |
|--|---|--|
| No operation indication | No mains connection, the ON/OFF ① switch is set to position "0" | Check the connections of the mains cable. Set the ON/OFF ① switch to position "1". |
| No RF signal | Transmitter and receiver operate in different frequency ranges | Perform a frequency scan (see page 56) and then synchronize transmitter and receiver. |
| | The transmission range is exceeded | Reduce the distance between transmitter and receiver. |
| Frequency cannot be transferred to the transmitter | The transmitter is not within the range of the infra-red interface | Place the transmitter at a distance of approx. 10–20 cm in front of the infra-red interface. |
| | The infra-red interface of the receiver is not yet ready for transferring the frequency, the receiver is still in scan mode | Keep placing the transmitter in front of the infra-red interface. |
| | The transmitter is from a different frequency range | Use a transmitter that matches the frequency range of the receiver. |
| Audio signal has a high level of background noise | Input gain of the transmitter/audio output level of the receiver is adjusted too low. | Adjust the input gain of the transmitter/audio output level of the receiver correctly. |
| Audio signal is distorted | Input gain of the transmitter/audio output level of the receiver is adjusted too high. | Adjust the input gain of the transmitter/audio output level of the receiver correctly. |
| The display does not switch on | The receiver is in standby mode | Press the jog dial ⑰. |
| syn▶ button does not seem to function | Wrong operating mode | Call up the "live" or "ch" operating mode before pressing the syn▶ button. |

SKM 9000 radio microphone

| Problem | Possible cause | Possible solution |
|---|--|---|
| Transmitter cannot be operated, "LOCK" appears on the display panel | Lock mode is activated | Deactivate the lock mode (see page 90). |
| No operation indication | Batteries are flat or accupack is flat | Replace the batteries or recharge the accupack (see page 94). |
| No RF signal at the receiver | Transmitter and receiver are not on the same frequency | Perform a frequency scan (see page 56) and then synchronize the transmitter and receiver. |
| | Transmission range is exceeded | Reduce the distance between transmitter and receiving antennas. |
| | Transmitter's RF signal is deactivated ("RF Mute") | Activate the RF signal (see page 78). |
| Audio signal has a high level of background noise or is distorted | Transmitter input gain is too low/too high | Adjust the input gain (see page 82). |

SK 9000 bodypack transmitter

| Problem | Possible cause | Possible solution |
|---|--|---|
| Transmitter cannot be operated, "LOCK" appears on the display panel | Lock mode is activated | Deactivate the lock mode (see page 99). |
| No operation indication | Batteries are flat or accupack is flat | Replace the batteries or recharge the accupack (see page 94). |
| No RF signal at the receiver | Transmitter and receiver are not on the same frequency | Perform a frequency scan (see page 56) and then synchronize the transmitter and receiver. |
| | Transmission range is exceeded | Reduce the distance between transmitter and receiving antennas. |
| | Transmitter's RF signal is deactivated ("RF Mute") | Activate the RF signal (see page 86). |
| Audio signal has a high level of background noise or is distorted | Transmitter input gain is too low/too high | Adjust the input gain (see page 90). |

L 60 charger

| Problem | Possible cause | Possible solution |
|-----------------------------|--|---|
| The LED ① does not light up | Charger is not connected to the mains | Check if the L 60 is connected to the NT 3-1 mains unit and if the mains unit is connected to the mains (see page 102). |
| | Cascaded L 60 chargers are not correctly connected to one another | Check if a maximum of four L 60 are correctly connected to one another (see page 46). |
| | More than four chargers are cascaded | |
| | Unstable voltage of the mains unit | Replace the defective mains unit or mains cable with a new one. |
| | Mains unit or mains cable is defective | |
| | No contact with the accupack | Insert the accupack correctly into the charging compartment (see page 102). |
| | Contacts of the accupack or contacts of the charging compartments are dirty | Clean the charging contacts of the accupack and of the charging compartments (see page 107). |
| | Accupack is defective (overaged or defective rechargeable battery cells) | Replace the defective accupack with a new one. |
| The LED ① flashes red | Wrong accupack/ individual rechargeable batteries/batteries (primary cells) have been inserted | Only charge BA 60 or BA 61 accupacks with the L 60 charger. |
| | Accupack temperature is too low or too high/ air humidity too high | Always recharge the accupack within the operating temperature range and the air humidity range stated in the specifications (see page 122). |
| | Accupack is defective (overaged or defective rechargeable battery cells) | Replace the defective accupack with a new one. |

If a problem occurs that is not listed in the above table or if the problem cannot be solved with the proposed solutions, please contact your local Sennheiser partner for assistance.

Digital 9000 Specifications

Specifications

System characteristics

| | | | |
|--------------------------|--|----------------------|--|
| Frequency ranges | 470 to 798 MHz, expandable to 934 MHz, divided into 24 MHz booster frequency ranges (see page 40) | | |
| | EM 9046 DRX | TX variant | Booster variant A1–A8 |
| | A1–B8 470–798 MHz (expandable to 934 MHz) | A1–A4 470–558 MHz | A1 470–494 MHz A2 494–518 MHz A3 510–534 MHz A4 534–558 MHz |
| | | A5–A8 550–638 MHz | A5 550–574 MHz A6 574–598 MHz A7 590–614 MHz A8 614–638 MHz |
| | | B1–B4 630–718 MHz | B1 630–654 MHz B2 654–678 MHz B3 670–694 MHz B4 694–718 MHz |
| | | B5–B8 710–798 MHz | B5 710–734 MHz B6 734–758 MHz B7 750–774 MHz B8 774–798 MHz |
| Transmission method | digital modulation "HD" mode: without audio data compression "LR" mode: SeDAC (Sennheiser Digital Audio Codec) | | |
| Audio frequency response | 30 Hz to 20 kHz (3 dB) with SK 9000 line-in 60 Hz to 20 kHz (3 dB) with SK 9000 mic 80 Hz to 20 kHz (3 dB) with SKM 9000 | | |
| Dynamic range | "HD" mode: 112 dB(A) "LR" mode: 101 dB(A) | | |
| Latency | Analog Audio Out: 3.2 ms Digital Audio Out: 3 ms (AES-EBU) | | |
| THD | "HD" mode: < 0.01 % (at 1 kHz) "LR" mode: < 0.03 % (at 1 kHz) | | |

Operating conditions

| | |
|--|--|
| Ambient temperature | -10 °C to +50 °C |
| Relative humidity | max. 85 % at 40 °C (non-condensing) |
| Protection against dripping and light splashing of liquids | the product must not be exposed to dripping and splashing (IP2X) |

Storage and transport conditions

| | |
|--|--|
| Ambient temperature | -25 °C to +70 °C |
| Relative humidity | max. 90 % at 40 °C |
| Protection against dripping and light splashing of liquids | the product must not be exposed to dripping and splashing (IP2X) |
| Shock resistance | as per IEC 68 or EN 60068, T2-27 |

EM 9046 characteristics

RF characteristics

| | |
|--------------------------------|---|
| Frequency range | 470 to 934 MHz |
| Receiving channels | up to 8 |
| Receiver principle | double superheterodyne |
| Diversity | true bit diversity |
| Sensitivity | "HD" mode: -86 dBm, "LR" mode: -100 dBm |
| Antenna inputs | 2 N-type sockets (50 Ω) |
| Daisy chain outputs | 2 N-type sockets (50 Ω), amplification: 11 dB ±0.5 dB (related to booster input) |
| Daisy chainable receivers (HF) | max. 4 EM 9046 (32 channels) |

Audio characteristics



| | |
|----------------------|---|
| Audio output voltage | XLR balanced, -10 dBu to +18 dBu in 1 dB steps (2 kΩ) |
| Headphone output | 2 x 100 mW at 32 Ω, short-circuit proof |
| Digital audio output | AES3-2003, XLR-3, 44.1 kHz; 48 kHz; 88.2 kHz or 96 kHz, 24 bit, externally synchronizable 8 XLR-3 sockets and 1 multicore/sub-D socket (25-pin) |
| Audio output sockets | can be equipped with 2 audio modules, analog (AAO), digital (DAO) or mixed 8 XLR-3 sockets and 1 multicore/sub-D socket (25-pin) per audio module |

Other characteristics

| | |
|-------------------|---|
| Power consumption | max. 250 W |
| Power supply | 100 to 240 V~, 50/60 Hz |
| Mains connector | 3-pin, protection class I as per IEC/EN 60320-1 |
| Dimensions | 177 x 449 x 496 mm (H x W x D, without handles) |
| Weight | approx. 17 kg (fully equipped with 1 AAO, 1 DAO, 8 DRX) |

| | |
|---------------------------|--|
| Booster supply | 12 V DC via antenna socket max. 200 mA each, short-circuit proof |
| LAN | IEEE 802.3-2002 (10/100 Mbit/s), shielded RJ 45 socket |
| Word clock input | BNC, 75 Ω , transformer balanced, AC-coupled input voltage range: 200 mV ... 5 Vpp max. input voltage: 15 V (DC + AC) |
| Word clock output | BNC, 75 Ω , AC-coupled output voltage: 3.0 Vpp \pm 500 mV at 75 Ω source impedance |
| Word clock sampling rates | 44.1 kHz; 48 kHz; 88.2 kHz or 96 kHz |

In compliance with

| | |
|---|---|
| Europe | EMC: EN 301489-1/-9 |
|  | Radio: EN 300422-1/-2 |
| | Safety: EN 60065 |
| USA |  47 CFR 15 subpart B |

Approved by

| | |
|--------|--|
| Canada | Industry Canada RSS-123, IC: 2099A-EM9000 |
|--------|--|

A/AB/AD 9000 characteristics



RF characteristics

| | |
|------------------------------|---|
| Frequency ranges | 470 MHz to 798 MHz, divided into 2 ranges: A1-A8: 470 MHz to 638 MHz B1-B8: 630 MHz to 798 MHz (see page 114) |
| Directivity | A 9000: omni-directional AD 9000: directional |
| Amplification | typ. 17 dB (constant) |
| Antenna input (AB 9000 only) | N-type socket (50 Ω) |
| Antenna output | N-type socket (50 Ω) |
| Antenna gain | A 9000: 3.2 dBi AD 9000: 4.6 dBi |
| Apex angle AD 9000 | approx. 100° (-3 dB) |
| Front-to-back ratio AD 9000 | \geq 14 dB |
| OIP3 | \geq 35 dBm |
| Preselection 24 MHz | automatic or manual (without EM 9046) via rotary switch |

Other characteristics

| | |
|---------------------|---|
| Current consumption | max. 160 mA at 12 V |
| Voltage range | 9 to 18 V |
| | DC feed via antenna cable from EM 9046 |
| Mounting connection | 3/8" or 5/8" thread |
| Dimensions | A 9000: 250 x 165 x 23 mm (H x W x D) AB 9000: 80 x 64 x 24 mm (H x W x D) AD 9000: 329 x 322 x 23 mm (H x W x D) |
| Weight | A 9000: approx. 390 g AB 9000: approx. 265 g AD 9000: approx. 625 g |

In compliance with

| | |
|---|---|
| Europe | EMC: EN 301489-1/-9 |
|  | Radio: EN 300422-1/-2 |
| | Safety: EN 60065 |
| USA |  47 CFR 15 subpart B |

Approved by

| | |
|--------|--|
| Canada | Industry Canada RSS-123, IC: 2099A-EM9000 |
|--------|--|

SK 9000 characteristics

RF characteristics

| | |
|----------------------|---|
| Frequency ranges | 470 MHz to 798 MHz, divided into 4 ranges: A1–A4: 470–558 MHz A5–A8: 550–638 MHz B1–B4: 630–718 MHz B5–B8: 710–798 MHz (see page 114) |
| Frequency ranges USA | 550 MHz to 698 MHz, divided into 2 ranges: A5–A8: 550–607.9 MHz and 614.1–638 MHz B1–B4: 630–697.9 MHz (see page 114) |
| Switching bandwidth | 88 MHz |
| RF output power | “HD” mode: 10 mW rms, 50 mW peak “LR” mode: 25 mW rms, 50 mW peak |
| Frequency stability | < 5 ppm |
| Tuneability | in steps of 25 kHz |
| Antenna output | coax socket |

Audio characteristics

| | |
|---------------------------------|--|
| Mic/line input | 3-pin special audio socket |
| Audio gain | mic: adjustable in 3 dB steps from 0 dB to +42 dB instruments: adjustable in 3 dB steps from -6 dB to +42 dB line: adjustable in 3 dB steps from -6 dB to +42 dB |
| Input impedance | mic: 22 k Ω instruments/line: 1 M Ω |
| Lower cut-off frequency (-3 dB) | mic: 30 Hz, 60 Hz, 80 Hz, 100 Hz, 120 Hz instruments/line: 30 Hz, 60 Hz, 80 Hz, 100 Hz, 120 Hz |
| Instrument cable emulation | cable length adjustable in 3 steps |

Other characteristics

| | |
|-------------------|---|
| Operating time | 6.5 hrs (with BA 61 accupack) |
| Power consumption | max. 960 mW |
| Dimensions | 76 x 62 x 20 mm (H x W x D, with BA 61 accupack) |
| Weight | approx. 147 g (with BA 61 accupack and belt clip) |

In compliance with

Europe



EMC: EN 301489-1/-9
Radio: EN 300422-1/-2
Safety: EN 60065
EN 62311 (SAR)

Approved by

USA

FC Part 74
FCC-ID: DMOSK9000
limited to 698 MHz

Canada

Industry Canada
RSS-123, IC: 2099A-SK9000
limited to 698 MHz

Brazil

QUANTA BRASIL IMPORTAÇÃO E EXPORTAÇÃO LTDA. 0927-15-7356



EUROBRAS FILM PRODUÇÕES CINEMATOGRAFICAS LTDA. 1350-15-7356



SKM 9000 characteristics

RF characteristics

| | |
|----------------------|---|
| Frequency ranges | 470 MHz to 798 MHz, divided into 4 ranges: A1–A4: 470–558 MHz A5–A8: 550–638 MHz B1–B4: 630–718 MHz B5–B8: 710–798 MHz (see page 114) |
| Frequency ranges USA | 550 MHz to 698 MHz, divided into 2 ranges: A5–A8: 550–607.9 MHz and 614.1–638 MHz B1–B4: 630–697.9 MHz (see page 114) |
| Switching bandwidth | 88 MHz |
| RF output power | “HD” mode: 10 mW rms, 50 mW peak “LR” mode: 25 mW rms, 50 mW peak |
| Frequency stability | < 5 ppm |
| Tuneability | in steps of 25 kHz |

Audio characteristics

| | |
|---------------------------------|--|
| Audio gain | adjustable in 3 dB steps from 0 dB to +62 dB (depending on microphone head) |
| Lower cut-off frequency (-3 dB) | adjustable: 60 Hz, 80 Hz, 100 Hz, 120 Hz |

Other characteristics

| | |
|-------------------|---|
| Operating time | 5.5 hrs (with BA 60 accupack) |
| Power consumption | max. 960 mW |
| Dimensions | 270 x 40 mm (L x Ø) |
| Weight | approx. 350 g (with BA 60 accupack and ME 9005 microphone head) |

In compliance with

| | |
|---|------------------------------------|
| Europe | EMC: EN 301489-1/-9 |
|  | Radio: EN 300422-1/-2 |
| | Safety: EN 60065 EN 62311 (SAR) |

Approved by

| | |
|--------|---|
| USA |  Part 74 FCC-ID: DMOSKM9000 limited to 698 MHz |
| Canada | Industry Canada RSS-123, IC: 2099A-SKM9000 limited to 698 MHz |

Brazil

QUANTA BRASIL IMPORTAÇÃO E EXPORTAÇÃO LTDA. 0927-15-7356



EUROBRAS FILM PRODUÇÕES CINEMATOGRAFICAS LTDA. 1350-15-7356



BA 60/61 characteristics

Other characteristics

| | BA 60 | BA 61 |
|------------------|-----------|-----------|
| Nominal voltage | 3.7 V | 3.7 V |
| Nominal capacity | 1,600 mAh | 2,030 mAh |
| Nominal energy | 5.9 Wh | 7.5 Wh |

In compliance with

Europe



EMC: EN 301489-1/-9
 EN 61000-6-2
 EN 61000-6-3
 Safety: IEC 60950
 IEC 62133

USA/Canada

Safety: UL 2054
 UL listing MH 16707

L 60 characteristics

| | |
|---|--|
| Input voltage | 12 to 15 V === |
| Input current | max. 900 mA |
| Pin assignment of DC input hollow jack socket |  |
| Charging voltage | max. 4.2 V === |
| Charging current | max. 2 x 1,000 mA |
| Charging principle | <ul style="list-style-type: none"> • CC CV method (Li-Ion charging method) • Deep discharge recovery charge • Capacity monitoring • Accupack temperature monitoring • Over/undercharge detection • Charging time limit (approx. 8 hours) |
| Compatible Sennheiser accupacks | <ul style="list-style-type: none"> • BA 60 (3.7 V, 1,600 mAh, Li-Ion) • BA 61 (3.7 V, 2,030 mAh, Li-Ion) |
| Charging time | <p>with a completely discharged accupack and at room temperature (approx. 20 °C/68° F):</p> <ul style="list-style-type: none"> • 100 % = approx. 180 min • 70 % = approx. 60 min • automatic security switch-off after approx. 8 hours |
| Dimensions | approx. 80 x 87 x 62 mm (W x D x H) |
| Weight | approx. 160 g (without mains unit) |

Operating conditions

| | |
|--|--|
| Ambient temperature | 0 °C to +35 °C with reduced charging power: 0 °C to +45 °C |
| Relative humidity | 25 % to 95 % (non-condensing) |
| Protection against dripping and light splashing of liquids | the product must not be exposed to dripping and splashing (IP2X) |

Storage and transport conditions

| | |
|--|--|
| Ambient temperature | -20 °C to +70 °C |
| Relative humidity | 5 % to 95 % (non-condensing) |
| Protection against dripping and light splashing of liquids | the product must not be exposed to dripping and splashing (IP2X) |

In compliance with

| | |
|---|-----------------------------------|
| Europe | EMC: EN 61000-6-2 EN 61000-6-3 |
|  | Safety: EN 60065 |
| USA | FCC 47 CFR Part 15 B |
| Canada | Industry Canada ICES 003 |

Pin assignment of the sockets of the EM 9046

| XLR-3 socket (analog & digital) | Pin assignment |
|---|--|
|  | <p>Pin 1: ground Pin 2: out + (P) Pin 3: out – (N)</p> |

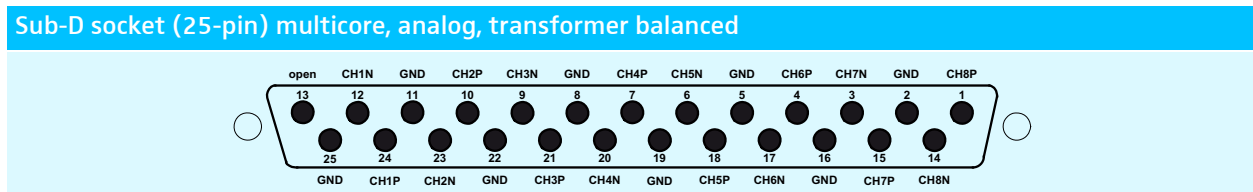
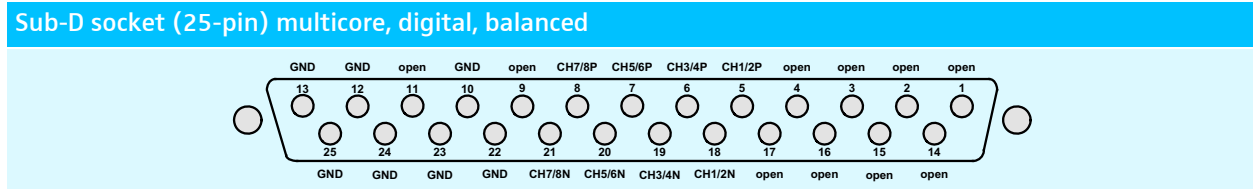

Pin assignment of the 3-pin special audio socket of the SK 9000

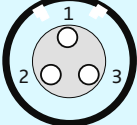
| Socket | Pin assignment |
|---|--|
|  | <p>Pin 1 and thread: ground Pin 2: line/Instrument Pin 3: microphone</p> |

Frequency ranges for Japan

The Japanese version of the SK 9000 and SKM 9000 transmitters is available in three frequency ranges.

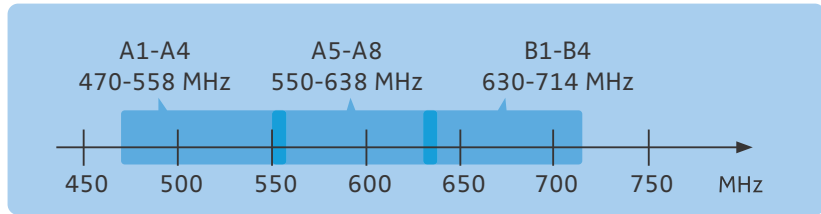

Japanese Radio Law and Japanese Telecommunications Business Law Compliance

This device is granted pursuant to the Japanese Radio Law () and the Japanese Telecommunications Business Law ().

This device should not be modified. Otherwise the granted designation number will become invalid.

JAP

| Japan | |
|--|---------------------|
|  | SK 9000 202-LSB007 |
| | SKM 9000 202-LSB008 |

Frequency ranges for Korea

The Korean version of the SK 9000 and SKM 9000 transmitters is available in three frequency ranges.

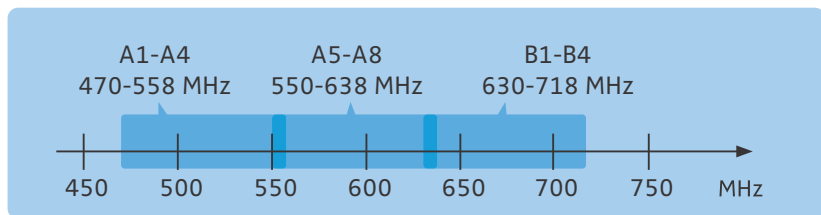



Sennheiser electronic GmbH & Co. KG

Am Labor 1, 30900 Wedemark, Germany

www.sennheiser.com

Publ. 06/17