







EK 2000 IEM



Instruction manual

Tastensymbole / Button icons / Icônes de touches /
 Simboli dei tasti / Símbolos de las teclas / Toetssymbolen /
 Símbolos dos botões / СИМВОЛЫ КНОПОК / 按键图标

	Taste ON/OFF / ON/OFF button / Touche ON/OFF / Tasto ON/OFF / Botón ON/OFF / Toets ON/OFF / Botão ON/OFF / Кнопка ON/OFF / 开关键 ON/OFF
	ON/OFF drücken / Press the ON/OFF button / Appuyer sur la touche ON/OFF / Premere ON/OFF / Pulsar ON/OFF / ON/OFF indrukken / Premir ON/OFF / Нажать ON/OFF / 按 ON/OFF 键
	Taste SET / SET button / Touche SET / Tasto SET / Botón SET / Toets SET / Botão SET / Кнопка SET / 设置键 SET
	SET drücken / Press the SET button / Appuyer sur la touche SET / Premere SET / Pulsar SET / SET indrukken / Premir SET / Нажать SET / 按 SET 键
	Taste UP/DOWN / Button UP/DOWN / Touche UP/DOWN / Tasto UP/DOWN / Tecla UP/DOWN / Toets UP/DOWN / Botão UP/DOWN / Кнопка UP/DOWN / 上下键 UP/DOWN
	Taste UP/DOWN drücken / Press the button UP/DOWN / Appuyer sur la touche à bascule UP/DOWN / Premere il tasto UP/DOWN / Pulsar tecla UP/DOWN / De toets UP/DOWN indrukken / Premir o botão UP/DOWN / Нажать кнопку UP/DOWN / 上下键 UP/DOWN

Contents

Important safety instructions	2
The EK 2000 IEM diversity receiver	4
Areas of application	4
The frequency bank system	5
Delivery includes	6
Product overview	7
Overview of the EK 2000 IEM diversity receiver	7
Overview of the displays	8
Putting the diversity receiver into operation	10
Inserting the batteries/accupack	10
Charging the accupack	10
Connecting the earphones	11
Attaching the diversity receiver to clothing	11
Using the diversity receiver	13
Switching the diversity receiver on/off and adjusting the volume ...	13
Deactivating the lock mode temporarily	14
Selecting a standard display	15
Using the operating menu	16
The buttons	16
Overview of the operating menu	16
Working with the operating menu	18
Synchronizing a transmitter with the diversity receiver	20
Setting the transmitters to intermodulation-free channels (Easy Setup Sync)	20
Synchronizing transmitters with diversity receivers (Sync)	21
Cleaning the diversity receiver	21
Recommendations and tips	22
If a problem occurs	23
Accessories	24
Specifications	25



For further information, visit the EK 2000 IEM product page on our website at www.sennheiser.com.

Important safety instructions

- Read this instruction manual.
- Keep this instruction manual. Always include this instruction manual when passing the product on to third parties.
- Heed all warnings and follow all instructions.
- Use only a cloth for cleaning the product.
- Do not place the product near any heat sources such as radiators, stoves, or other devices (including amplifiers) that produce heat.
- Only use attachments/accessories specified by Sennheiser.
- Refer all servicing to qualified service personnel.

Service is required if the product has been damaged in any way, liquid has been spilled, objects have fallen inside, the product has been exposed to rain or moisture, does not operate properly or has been dropped.

- **WARNING:** To reduce the risk of short circuits, do not use the product near water and do not expose it to rain or moisture.
- This product is also intended for professional use. Commercial use is subject to the safety-at-work regulations. Sennheiser, as the manufacturer, is therefore obliged to expressly point out possible health risks arising from use.

This product is capable of producing sound pressure exceeding 85 dB(A). 85 dB(A) is the sound pressure corresponding to the maximum permissible volume which is by law (in some countries) allowed to affect your hearing for the duration of a working day. It is used as a basis according to the specifications of industrial medicine. Higher volumes or longer durations can damage your hearing. At higher volumes, the duration must be shortened in order to prevent hearing damage. The following are sure signs that you have been subjected to excessive noise for too long a time:

- You can hear ringing or whistling sounds in your ears.
- You have the impression (even for a short time only) that you can no longer hear high notes.

Intended use

Intended use of the EK 2000 IEM diversity receiver includes:

- having read this instruction manual, especially the chapter “Important safety instructions”,
- using the product within the operating conditions and limitations described in this instruction manual.

“Improper use” means using the product other than as described in these instructions, or under operating conditions which differ from those described herein.

The EK 2000 IEM diversity receiver

This diversity receiver is part of the 2000 series. With this series, Sennheiser offers high-quality state-of-the-art RF transmission systems with a high level of operational reliability and ease of use. Transmitters and receivers are designed for monitoring applications and permit wireless transmission with studio-quality sound.

Features of the 2000 series:





- Optimized PLL synthesizer and microprocessor technology
- HDX noise reduction system
- Adaptive diversity technology
- Switching bandwidth of up to 75 MHz
- Scan function (Easy Setup) for scanning the frequency banks for unused channels
- Adjustable and switchable limiter

Adaptive Diversity

This diversity receiver uses the ground connection of the earphones cable as its second antenna to provide improved reception.

Areas of application

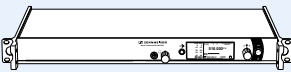
The receiver can be combined with the SR 2000 IEM and SR 2050 IEM transmitters.

Diversity receiver	Earphones	Transmitters
EK 2000 IEM 	IE 4 	SR 2000 IEM  SR 2050 IEM 

These transmitters are available in the same UHF frequency ranges and are equipped with the same frequency bank system with factory-preset frequencies. An advantage of the factory-preset frequencies is that

- a transmission system is ready for immediate use after switch-on,
- several transmission systems can be operated simultaneously on the preset frequencies without causing intermodulation interference.

The frequency bank system

The receiver is available in 6 UHF frequency ranges with up to 3,000 receiving frequencies per frequency range:

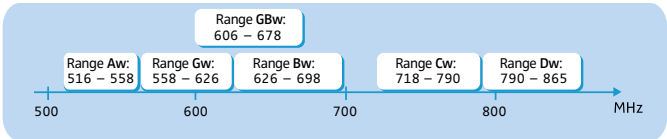

Each frequency range (Aw–Dw, Gw, GBw) offers 26 frequency banks with up to 32 channels each:

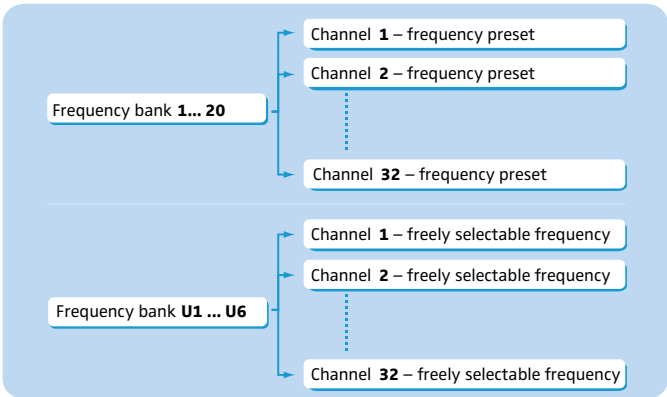

Each of the channels in the frequency banks "1" to "20" has been factory-preset to a fixed frequency (frequency preset). The factory-preset frequencies within one frequency bank are intermodulation-free. These frequencies cannot be changed.

For an overview of the frequency presets, please refer to the supplied frequency information sheet. Updated versions of the frequency information sheet can be downloaded from the EK 2000 IEM product page on our website at www.sennheiser.com.

The frequency banks "U1" to "U6" allow you to freely select and store frequencies. It might be that these receiving frequencies are **not** intermodulation-free (see page 20).

Delivery includes

The packaging contains the following items:

- 1 EK 2000 IEM diversity receiver
- 1 pair of IE4 earphones
- 1 instruction manual
- 1 frequency information sheet

Product overview

Overview of the EK 2000 IEM diversity receiver

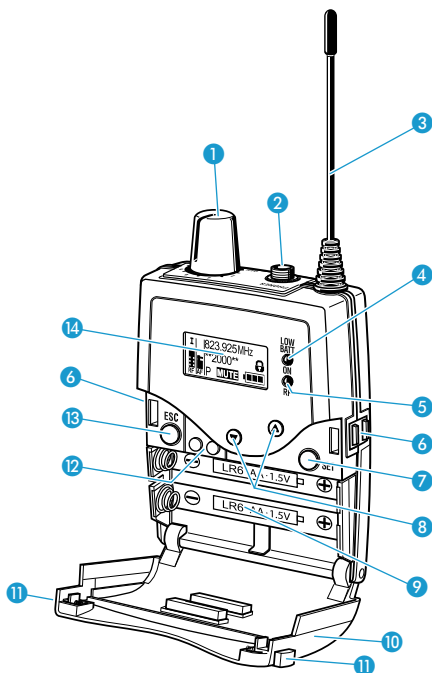

- | | |
|--|---|
| 1 On/off/volume control | 7 SET button |
| 2 Headphone output (PHONES),
3.5 mm stereo jack socket, lockable
(the shielding is used by antenna II) | 8 UP/DOWN button ▲/▼ |
| 3 Antenna I | 9 Battery compartment |
| 4 Operation and battery status
indicator, red LED
(lit = ON, flashing = LOW BATT) | 10 Battery compartment cover
(metal) |
| 5 RF signal indication, green LED
(lit = RF) | 11 Battery compartment catches |
| 6 Charging contacts | 12 Infra-red interface |
| | 13 ESC button |
| | 14 Display panel, backlit in orange |





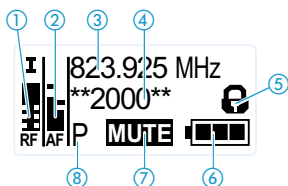

Overview of the displays

After switch-on, the diversity receiver displays the standard display “Frequency/Name”. For further illustrations and examples of the different standard displays, refer to page 15.

The display backlighting is automatically reduced after approx. 20 seconds.

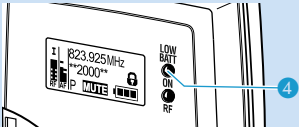

Display	Meaning
① RF level “RF” (Radio Frequency)	<p>Diversity display:</p> <ul style="list-style-type: none"> I Antenna input I is active II Antenna input II is active Squelch threshold level RF signal level: Field strength of the received signal
② Audio level “AF” (Audio Frequency)	<p>Modulation of the transmitter (channel-separated when the transmitter is set to stereo mode)</p> <p>Peak hold function</p> <p>When the display shows full deflection, the audio input level is excessively high.</p>
③ Frequency	Current receiving frequency
④ Name	Freely selectable name of the receiver
⑤ Lock mode icon	Lock mode is activated (see page 14)

Display	Meaning
⑥ Battery status	<p>Charge status:</p> <ul style="list-style-type: none">  approx. 100%  approx. 70%  approx. 30%  charge status is critical, the red LOW BATT LED ④ is flashing: 
⑦ Muting function "MUTE"	<p>"Mute" is only displayed on the "Frequency/Name" standard display (see page 15)</p> <ul style="list-style-type: none"> • when the transmitter's RF signal is deactivated or • when the transmitter is set to mono mode and therefore does not transmit a pilot tone but the receiver's pilot tone evaluation is activated.
or audio channels	<p>The audio channels are only displayed on the "Frequency/Limiter" and "Frequency/High Boost" standard displays (see page 15)</p> <ul style="list-style-type: none">  Stereo  Focus
⑧ Pilot tone "P"	Activated pilot tone evaluation

Putting the diversity receiver into operation

Inserting the batteries/accupack

For powering the diversity receiver, you can either use two 1.5 V AA size batteries or the rechargeable Sennheiser BA 2015 accupack (see "Accessories" on page 24).

- ▶ Open the battery compartment by pushing the two catches **11** in the direction of the arrows and open the cover **10**.

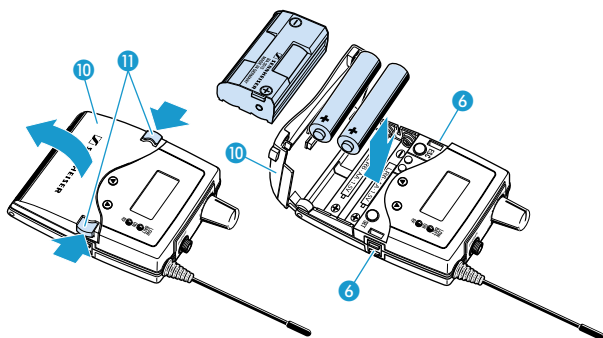

- ▶ Insert the two batteries or the accupack as shown above. Please observe correct polarity when inserting the batteries/accupack.
- ▶ Close the battery compartment by pressing on the center of the cover **10**.
The battery compartment cover **10** locks into place with an audible click.

Charging the accupack

To charge the BA 2015 accupack (see "Accessories" on page 24) installed in the diversity receiver:

- ▶ Insert the diversity receiver into the L 2015 charger ((see "Accessories" on page 24)).



The L 2015 charger can only charge the combination BA 2015 accupack/diversity receiver. Standard batteries (primary cells) or individual rechargeable battery cells cannot be charged.

Connecting the earphones

- ▶ Connect the earphones to the socket 2.

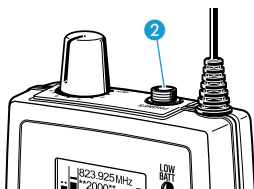

The ground connection of the earphones cable serves as the antenna for the second diversity section. For details on the connector assignment, refer to the diagram on page 26.

Attaching the diversity receiver to clothing

You can use the belt clip 18 to attach the diversity receiver to clothing (e.g. belt, waistband).

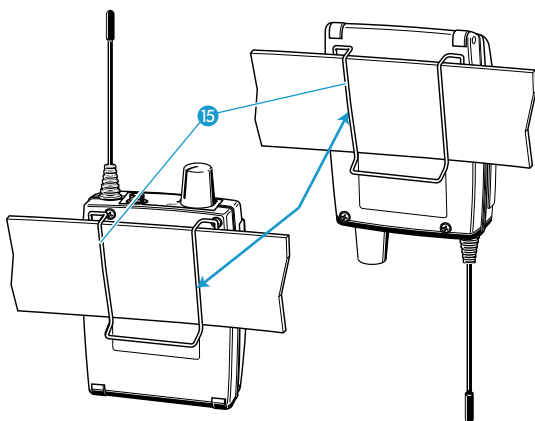

The belt clip is detachable so that you can also attach the diversity receiver with the antenna pointing downwards. To do so, withdraw the belt clip from its fixing points and attach it the other way round. The belt clip is secured so that it cannot slide out of its fixing points accidentally.

Putting the diversity receiver into operation

To detach the belt clip:

- ▶ Lift one side of the belt clip as shown.

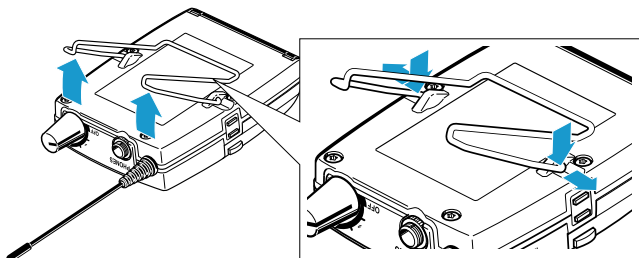

- ▶ Press down the belt clip at one fixing point and pull it out of the housing.
- ▶ Repeat for the other side.

Using the diversity receiver

To establish a transmission link, proceed as follows:

1. Switch the transmitter on (see the instruction manual of the transmitter).
2. Switch the diversity receiver on (see next section).
The transmission link is established and the receiver's RF level display "RF" ① reacts.



It is vital to observe the notes on frequency selection on page 20.

- ▶ If you cannot establish a transmission link between transmitter and receiver, read the chapter "Synchronizing a transmitter with the diversity receiver" on page 20.

Switching the diversity receiver on/off and adjusting the volume

To switch the diversity receiver **on**:

- ▶ Turn the volume control ① clockwise until it clicks.
The red **ON** LED ④ lights up. The "Frequency/Name" standard display appears on the display panel.

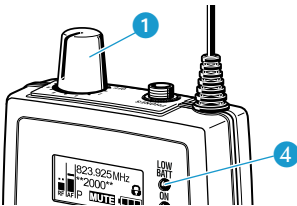

To switch the diversity receiver **off**:

- ▶ Turn the volume control ① counterclockwise until it clicks.
The red **ON** LED ④ goes off and the diversity receiver switches off.

To adjust the **volume**:

CAUTION! Danger of hearing damage!



Listening at high volume levels for long periods can lead to permanent hearing defects.

- ▶ Set the volume to a low level before putting the earphones on.
- ▶ Do **not** continuously expose yourself to high volumes.

- ▶ Turn the volume control ①.

Deactivating the lock mode temporarily



You can activate or deactivate the automatic lock mode via the “Auto Lock” menu item. If the lock mode is activated, you have to temporarily deactivate it in order to be able to operate the receiver:







- ▶ Press the **SET** button.
“Locked” appears on the display panel.
- ▶ Press the UP/DOWN button ▲/▼.
“Unlock?” appears on the display panel.
- ▶ Press the **SET** button.
 - When you are in the operating menu, the lock mode remains deactivated until you exit the operating menu.
 - When one of the standard displays is shown, the lock mode is automatically activated after 10 seconds.

The lock mode icon ⑤ flashes prior to the lock mode being activated again.

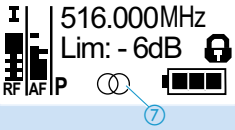

Selecting a standard display

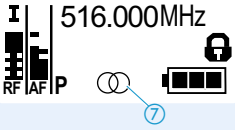
ESC  Press the **ESC** button to select a standard display. In stereo mode you can alternatively press the UP/DOWN button /▼.



Contents of the display	Selectable standard display
	<p>“Frequency/Name” with “MUTE” display </p>
	<p>“Frequency/Limiter” with display of the audio channels (Stereo/ Focus) </p>
	<p>“Frequency/High Boost” with display of the audio channels (Stereo/ Focus) </p>

For more information, refer to the chapter “Overview of the displays” on page 8.

Using the operating menu

A special feature of the Sennheiser 2000 series is the consistent, intuitive menu structure of transmitters and receivers. As a result, adjustments to the settings can be made quickly – even in stressful situations, for example on stage or during a live show or presentation.

The buttons

Button	Function of the button
Press the ESC button 	<ul style="list-style-type: none"> • Selects a standard display (see page 15) • Cancels the entry and returns to the current standard display (ESC function)
Press the SET button 	<ul style="list-style-type: none"> • Changes from the current standard display to the operating menu • Calls up a menu item • Enters a submenu • Stores the settings and returns to the operating menu
Press the UP/DOWN button 	<ul style="list-style-type: none"> • In Focus mode: Adjusts the balance • In stereo mode: Selects a standard display (see page 15) • Changes to the next/previous menu item • Changes the setting of a menu item

Overview of the operating menu

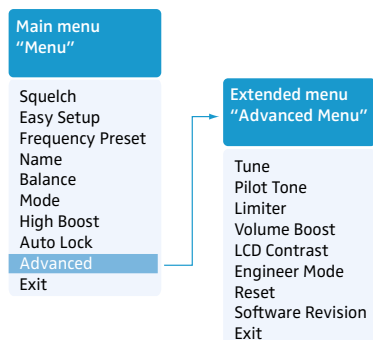

Display	Function of the menu item
---------	---------------------------

Main menu "Menu"

Squelch	Adjusts the squelch threshold
Easy Setup	Scans for unused frequency presets, releases and selects frequency presets
Frequency Preset	Sets the frequency bank and the channel
Name	Enters a freely selectable name
Balance	Adjusts the balance
Mode	Selects stereo or Focus mode
High Boost	Activates/deactivates the treble boost
Auto Lock	Activates/deactivates the automatic lock mode
Advanced	Calls up the extended menu "Advanced Menu"
Exit	Exits the operating menu and returns to the current standard display

Extended menu "Advanced Menu"

Tune	Sets the receiving frequencies for the frequency banks "U1" to "U6"
	Sets the channel and the receiving frequency for the frequency banks "U1" to "U6"
Pilot Tone	Activates/deactivates the pilot tone evaluation
Limiter	Adjusts the limiter
Volume Boost	Adjusts the volume boost
LCD Contrast	Adjusts the contrast of the display panel
Engineer Mode	Adjusting the menu item and loading profiles
Reset	Resets the settings made in the operating menu
Software Revision	Displays the current software revision
Exit	Exits the extended menu "Advanced Menu" and returns to the main menu

Working with the operating menu





If the lock mode is activated, you have to deactivate it in order to be able to work with the operating menu (see page 14).

By way of example of the “Frequency Preset” menu, this section describes how to use the operating menu.

Changing from a standard display to the operating menu

-  Press the **SET** button.
The current standard display is replaced by the main menu.
The last called up menu item is displayed.





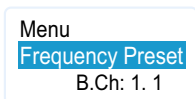

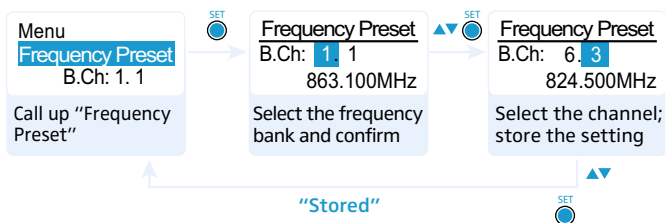

Selecting a menu item

-  Press the UP/DOWN button / to change to the “Frequency Preset” menu item.
The current setting of the selected menu item is displayed:



Changing and storing settings



-  Press the **SET** button to call up the menu item.
-  Press the UP/DOWN button / to set the frequency bank.
-  Press the **SET** button to confirm your selection.
-  Press the UP/DOWN button / to set the channel.
-  Press the **SET** button to store the setting.

Canceling an entry



-  Press the **ESC** button to cancel the entry.
The current standard display appears on the display panel.

To subsequently return to the last edited menu item:

-  Press the **SET** button repeatedly until the last edited menu item appears.

Exiting a menu item

To return to the next higher menu level:

-   Press the **▼▲** buttons to change to the “Exit” menu item.

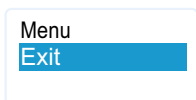

-  Confirm your selection.
You return to the next higher menu level or you exit the operating menu and return to the current standard display.

To directly return to the current standard display:

-  Press the **ESC** button.

Synchronizing a transmitter with the diversity receiver



When synchronizing the SR 2000 IEM or SR 2050 IEM transmitter with a diversity receiver, please observe the following:

- ▶ Only use a transmitter and a diversity receiver from the same frequency range (see the type plate on the transmitter and the diversity receiver).
- ▶ Make sure that the desired frequencies are listed in the enclosed frequency information sheet.
You can also contact your Sennheiser partner who will be pleased to calculate intermodulation-free frequencies for you.
- ▶ Make sure that the desired frequencies are approved and legal in your country and, if necessary, apply for an operating license.

Setting the transmitters to intermodulation-free channels (Easy Setup Sync)

Upon delivery, the SR 2000 IEM or SR 2050 IEM transmitter and the diversity receiver are synchronized with each other. If, however, you cannot establish a transmission link between transmitter and diversity receiver, you first have to use the diversity receiver to determine intermodulation-free channels and then transfer these channels to the transmitters. In doing so, no transmission links are established.

- ▶ On all transmitters, call up the “Easy Setup” menu item.
“Easy Setup Sync” appears on the display panels of the transmitters. The RF signals of the transmitters are deactivated. The transmitters await the transfer of a channel and a frequency bank via their infra-red interfaces.
- ▶ With a diversity receiver, perform a frequency preset scan to scan the frequency banks for unused channels (“Scan New List”).
- ▶ Select a frequency bank with a sufficient number of unused channels and a channel on this receiver (“Current List”).
- ▶ Start the Easy Setup Sync function by placing the infra-red interface of this diversity receiver in front of the infra-red interfaces of all transmitters, one after the other.
The diversity receiver transfers an unused channel from the selected frequency bank to the first transmitter and the next unused channel to the second transmitter and so on. As soon as a transfer is completed, the display panel of the transmitter displays the numbers of the transferred frequency bank and channel.

Synchronizing transmitters with diversity receivers (Sync)

In a second step, you transfer the frequency bank and channel settings from the transmitters to other diversity receivers (synchronization) and thus establish the transmission links.

If you want to carry out synchronization at a later time:

- ▶ Press the jog dial on the transmitter.
The frequency bank and the channel are stored. The transmitter's RF signal is activated again. You can synchronize this transmitter with a diversity receiver at any time (see the instruction manual of the transmitter).

To carry out synchronization immediately:

- ▶ Start the synchronization function by placing the infra-red interface of the first diversity receiver in front of the infra-red interface of the first transmitter while simultaneously pressing the **SYNC** button on the transmitter.
The diversity receiver is set to the same frequency bank and channel as the transmitter. The transmitter's RF signal is activated again. A transmission link is established between the first transmitter and the first diversity receiver.
- ▶ Synchronize each of the remaining transmitters with one of the remaining diversity receivers.
Your multi-channel monitoring system is now ready for operation.

Instead of synchronizing, you can manually set the transmitters to the same frequency bank and channel that you set on the corresponding diversity receivers.

Cleaning the diversity receiver

CAUTION! Liquids can damage the electronics of the diversity receiver!

Liquids entering the housing of the device can cause a short-circuit and damage the electronics.

- ▶ Keep all liquids away from the diversity receiver.
- ▶ Do not use any solvents or cleansing agents.

-
- ▶ Use a cloth to clean the diversity receiver from time to time.

Recommendations and tips

... for the diversity receiver

- Make sure that the antenna and the earphones cable do not cross.
- For best results, make sure that the transmitter sensitivity is correctly adjusted.

... for optimum reception

- Transmission range depends to a large extent on location and can vary from about 10 m to about 150 m. There should be a "free line of sight" between transmitting and receiving antennas.
- To avoid overloading the receiver, observe a minimum distance of 5 m between transmitting and receiving antennas.

... for multi-channel operation

- When operating a multi-channel system, you should only use the channels within one frequency bank. Each of the frequency banks "1" to "20" accommodates factory-preset frequencies which are intermodulation-free.
- The frequency banks "U1" to "U6" allow you to freely select and store receiving frequencies.
- When using several transmitters simultaneously, interference can be avoided by maintaining a minimum distance of 20 cm between two transmitters.

If a problem occurs ...

Problem	Possible cause	Possible solution
Diversity receiver cannot be operated, "Locked" appears on the display panel	Lock mode is activated	Deactivate the lock mode (see page 14).
No operation indication	Batteries are flat or accupack is flat	Replace the batteries or recharge the accupack (see page 10).
No RF signal	Transmitter and receiver are not on the same channel	Set the transmitter and receiver to the same channel. Synchronize the transmitter with the receiver (see page 20).
	Transmission range is exceeded	Check the squelch threshold setting. Reduce the distance between transmitter and receiving antennas.
	RF signal is deactivated ("RF Mute")	Activate the RF signal (see the instruction manual of the transmitter).
RF signal available, no audio signal, "MUTE" appears on the display panel	Transmitter is muted	Cancel the muting (see the instruction manual of the transmitter).
	Receiver's squelch threshold is adjusted too high	Reduce the squelch threshold setting on the receiver.
	Transmitter is set to mono operation and therefore doesn't transmit a pilot tone	Deactivate the pilot tone evaluation.
	Transmitter is set to stereo operation and therefore transmits a pilot tone	Activate the pilot tone evaluation.

Problem	Possible cause	Possible solution
Audio signal has a high level of background noise	Transmitter sensitivity is adjusted too low	Adjust the transmitter sensitivity correctly (see the instruction manual of the transmitter).
Audio signal is distorted	Transmitter sensitivity is adjusted too high	Adjust the transmitter sensitivity correctly (see the instruction manual of the transmitter).
No access to a certain channel	During scanning, an RF signal has been detected on this channel and the channel has been locked	Set the transmitter operating on this channel to a different channel and redo the frequency preset scan.
	During scanning, a transmitter of your system operating on this channel has not been switched off	Switch the transmitter off and redo the frequency preset scan.

If a problem occurs that is not listed in the above table or if the problem cannot be solved with the proposed solutions, please contact your local Sennheiser partner for assistance.

To find a Sennheiser partner in your country, search at www.sennheiser.com under "Service & Support".

Accessories

The following EK 2000 IEM accessories are available from your specialist dealer:

Cat. No.	Accessory
009950	BA 2015 accupack
009828	L 2015 charger
500432	IE 4 earphones

Specifications

RF characteristics

Modulation	wideband FM
Frequency ranges	516–558, 558–626, 626–698, 718–790, 790–865, 606–678 MHz (Aw to Dw, Gw, GBw, see page 5)
Receiving frequencies	up to 3,000 receiving frequencies, tuneable in steps of 25 kHz 20 frequency banks, each with up to 32 factory-preset channels 6 frequency banks, each with up to 32 user programmable channels
Switching bandwidth	up to 75 MHz
Nominal/peak deviation	± 24 kHz/ ± 48 kHz
Receiver principle	adaptive diversity
Sensitivity (with HDX, peak deviation)	< 4 μ V, typ. < 1.6 μ V for 52 dBA _{rms S/N}
Adjacent channel rejection	typ. ≥ 80 dB
Intermodulation attenuation	typ. ≥ 78 dB
Blocking	≥ 80 dB
Squelch	Off, 5 to 25 dB μ V, adjustable in steps of 2 dB
Pilot tone squelch	can be switched off

AF characteristics



Compander system	Sennheiser HDX
S/N ratio (1 mV, peak deviation)	approx. 90 dB
THD	$\leq 0.9\%$
Output power at 2.4 V, 5% THD, nominal deviation	2 x 100 mW at 32 Ω
High Boost	+8 dB at 80 kHz
Limiter	-18 dB to -6 dB, adjustable in steps of 3 dB, can be switched off

Specifications

Overall device

Temperature range	-10°C to +55°C
Power supply	2 AA size batteries, 1.5 V or BA 2015 accupack
Nominal voltage	2.4 V = = =
Power consumption:	
• at nominal voltage	approx. 140 mA
• with switched-off receiver	≤ 25 μA
Operating time	approx. 4 to 6 hrs (depending on volume level)
Dimensions	approx. 82 x 64 x 24 mm
Weight (incl. batteries)	approx. 140 g

In compliance with

Europe	 EMC: EN 301489-1/-9 Radio: EN 300422-1/-2 Safety: EN 60065
USA	 47 CFR 15 subpart B

Approved by

Canada	Industry Canada RSS-123 IC 2099A-EK2000IEM limited to 698 MHz
--------	---

Connector assignment

3.5 mm jack plug, stereo

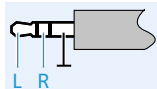



Sennheiser electronic GmbH & Co. KG

Am Labor 1, 30900 Wedemark, Germany
www.sennheiser.com

Publ. 12/16, 549124/A03