



MKH 70-1

Quick Guide
 Kurzanleitung
 Guide de démarrage rapide
 Guida rapida
 Instrucciones resumidas
 Instruções resumidas
 Beknopte gebruiksaanwijzing
 Krótka instrukcja obsługi
 Snabbguide

Kort vejledning
 Pikaohje
 Γρήγορος οδηγός
 Kısa Kılavuz
 Краткая инструкция
 快速指南
 快速使用指南
 クイックガイド
 퀵 가이드



SENNHEISER

In the box

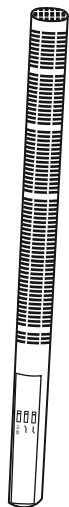

Overview

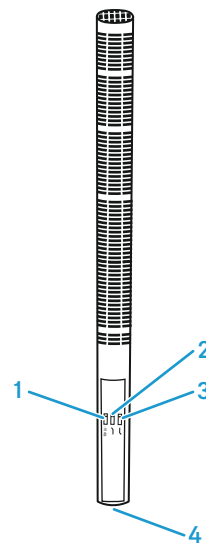

- 1 switch for preattenuation
- 2 switch for roll-off-filter
- 3 switch for presence filter
- 4 XLR-3 connector

Adjusting

Adjusting

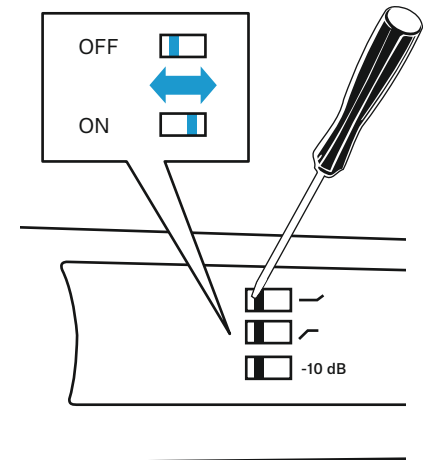

Accessories

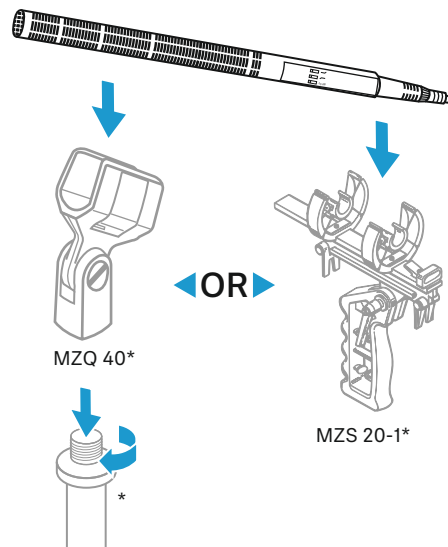

MZS 20-1*
+
MZW 70-1*

+
MZH 70-1*

* not included



Online at
www.sennheiser.com/download
 MKH 70-1_

Sennheiser electronic GmbH & Co. KG

Am Labor 1, 30900 Wedemark, Germany
www.sennheiser.com

Printed in Germany, Publ. 09/19, 583991/A01

Power supply and connections

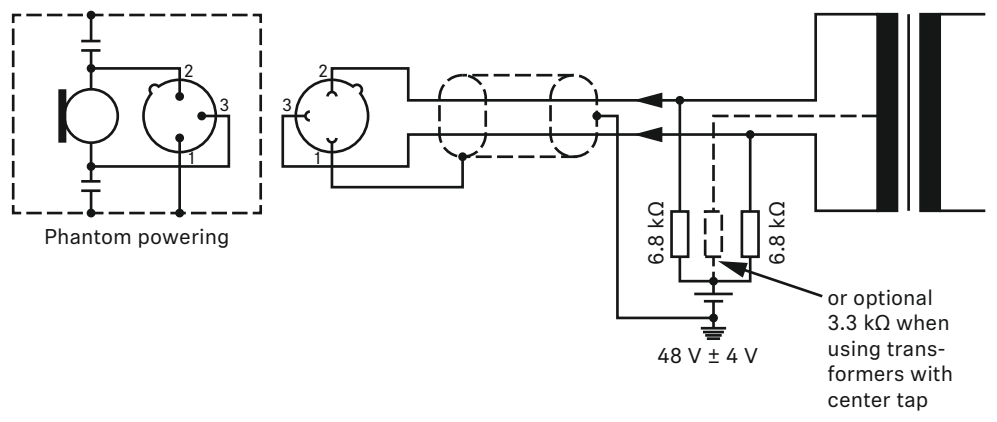

Cleaning

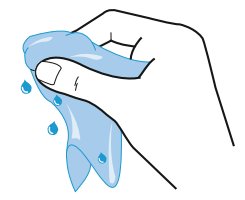
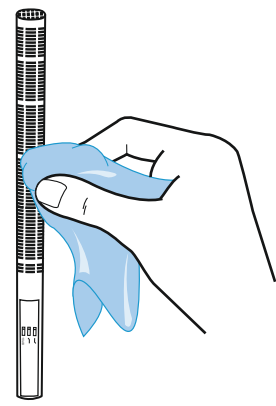

Specifications

Pick-up pattern	super-cardioid/lobar
Frequency response	50 – 20,000 Hz
Sensitivity (free field, no load, 1 kHz)	50 (15) mV/Pa ±1 dB
Max. SPL	124 (132) dB / 1 kHz
Equivalent noise level	
DIN IEC 651	5 (13) dB(A)
CCIR 468-3	16 (24) dB
Nominal impedance	150 Ω
Min. terminating impedance	1 kΩ
Phantom powering	48 V ± 4 V
Current consumption	2 mA
Dimension	∅ 25 x 410 mm
Weight	approx. 180 g

Values in () with attenuator switched on (-10 dB)

Polar pattern and frequency response

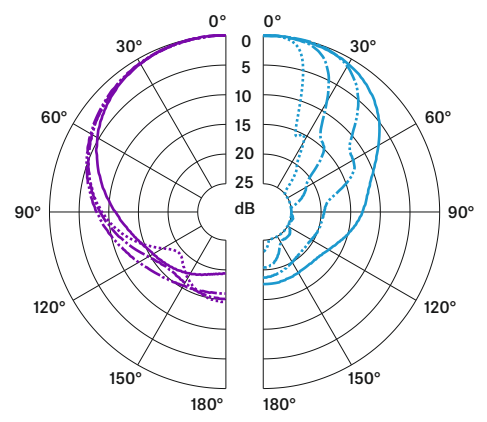

- 125 Hz (dotted purple)
- 250 Hz - - - - (dashed purple)
- 500 Hz - · - · - (dash-dot purple)
- 1,000 Hz ——— (solid purple)
- 2,000 Hz ——— (solid blue)
- 4,000 Hz - · - · - (dash-dot blue)
- 8,000 Hz - - - - (dashed blue)
- 16,000 Hz (dotted blue)

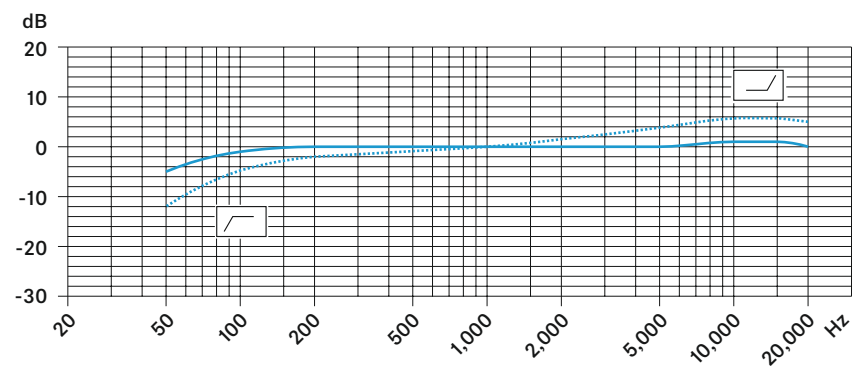

- Effect of switchable roll-off-filter
- Effect of switchable treble emphasis