



evolution wireless G4 ew 100 G4-ME2/835-S | Combo Set



Versatile wireless systems for those who sing, speak or play instruments with up to 42 MHz tuning bandwidth in a stable UHF range and fast, simultaneous setup of up to 12 linked systems.

Dynamic handheld microphone e 835, robust bodypack transmitter and easy clip-on microphone ME 2-II (omni-directional) with high speech intelligibility for daily use on stage.

FEATURES

- Engineered for professional live sound: Rugged all-in-one combo wireless system for singers, presenters and moderators.
- Dynamic handheld microphone e 835, robust bodypack transmitter and unobtrusive clip-on microphone ME 2-II (omni-directional) with high speech intelligibility for daily use on stage
- True diversity half-rack receiver in a full-metal housing with intuitive LCD display for full control
- Easy and flexible wireless synchronization between transmitter and receiver via infrared
- Fast frequency allocation for up to 12 receivers via new linking functionality
- Up to 20 compatible channels
- Up to 42 MHz bandwidth with 1680 selectable frequencies, fully tunable in a stable UHF range
- Transmission Range: up to 100 meters / 300 feet
- High RF output power (up to 30 mW) depending on country regulations

DELIVERY INCLUDES

- EM 100 G4
- SK 100 G4
- SKM 100-S G4
- MMD 835-1
- ME 2
- GA 3
- MZQ 1 microphone clamp
- power supply
- 4 AA batteries
- antennen
- RJ 10
- quick guide
- safety guide
- manufacturer declaration sheet
- frequency supplement sheet



evolution wireless G4

ew 100 G4-ME2/835-S | Combo Set

SPECIFICATIONS

EM 100 G4

RF characteristics	
Modulation	Wideband FM
Frequency ranges	A1: 470 - 516 MHz A: 516 - 558 MHz AS: 520 - 558 MHz G: 566 - 608 MHz GB: 606 - 648 MHz B: 626 - 668 MHz C: 734 - 776 MHz D: 780 - 822 MHz E: 823 - 865 MHz JB: 806 - 810 MHz K+: 925 - 937.5 MHz 1G8: 1785 - 1800 MHz
Receiving frequencies	Max. 1680 receiving frequencies, adjustable in 25 kHz steps 20 frequency banks, each with up to 12 factory-preset channels, no intermodulation 1 frequency bank with up to 12 programmable channels
Switching bandwidth	up to 42 MHz
Nominal/peak deviation	± 24 kHz / ± 48 kHz
Receiver principle	True diversity
Sensitivity (with HDX, peak deviation)	$< 2.5 \mu\text{V}$ for 52 dBA _{eff S/N}
Adjacent channel selection	Typically ≥ 65 dB
Intermodulation attenuation	Typically ≥ 65 dB
Blocking	≥ 70 dB

Squelch	low: 5 dB μV middle: 15 dB μV high: 25 dB μV
Pilot tone squelch	Can be switched off
Antenna inputs	2 BNC sockets

AF characteristics	
Compander system	Sennheiser HDX
EQ presets (switchable, act on line and monitor outputs)	Preset 1: Flat Preset 2: Low Cut (-3 dB at 180 Hz) Preset 3: Low Cut/High Boost (-3 dB at 180 Hz, +6 dB at 10 kHz) Preset 4: High Boost (+6 dB at 10 kHz)
Signal-to-noise ratio (1 mV, peak deviation)	≥ 110 dBA
Total harmonic distortion (THD)	≤ 0.9 %
AF output voltage (at peak deviation, 1 kHz AF)	6.3 mm jack socket (unbalanced): +12 dBu XLR socket (balanced): +18 dBu
Setting range "AF Out"	48 dB (3 dB steps)
Overall device	
---	---
Temperature range	-10 °C to +55 °C
Power supply	12 V DC
Current consumption	300 mA
Dimensions	Approx. 190 x 212 x 43 mm
Weight	Approx. 980 g

CONNECTIONS





evolution wireless G4

ew 100 G4-ME2/835-S | Combo Set

SPECIFICATIONS

SK 100 G4

RF characteristics	
Modulation	Wideband FM
Frequency ranges	A1: 470 - 516 MHz A: 516 - 558 MHz A10: 516 - 558 MHz AS: 520 - 558 MHz G: 566 - 608 MHz GB: 606 - 648 MHz B: 626 - 668 MHz B10: 626 - 668 MHz C: 734 - 776 MHz D: 780 - 822 MHz JB: 806 - 810 MHz E: 823 - 865 MHz K+: 925 - 937,5 MHz 1G8: 1785 - 1800 MHz
Transmission frequencies	Max. 1680 receiving frequencies, adjustable in 25 kHz steps 20 frequency banks, each with up to 12 factory-preset channels, no intermodulation 1 frequency bank with up to 12 programmable channels
Switching bandwidth	up to 42 MHz
Nominal/peak deviation	± 24 kHz / ± 48 kHz
Frequency stability	$\leq \pm 15$ ppm
RF output power at 50 Ω	Max. 30 mW
Pilot tone squelch	Can be switched off

SPECIFICATIONS

ME 2

Transducer principle	pre-polarized condenser microphone
Pick-up pattern	omni-directional
Sensitivity (free field, no load) (1 kHz)	20 mV/Pa
Max. SPL at 1 kHz	130 dB
Frequency response	50 to 18,000 Hz
Equivalent noise level A-weighted (DIN IEC 651)	36 dB
Connector	3.5 mm jack
Cable length	approx. 1.60 m
Supply voltage	7.5 V

AF characteristics

Compander system	Sennheiser HDX
AF frequency response	Mic: 80 - 18,000 Hz Line: 25 - 18,000 Hz
Signal-to-noise ratio (1 mV, peak deviation)	≥ 110 dBA
Total harmonic distortion (THD)	≤ 0.9 %
Max. microphone/line input voltage	3 V _{eff}
Microphone/line input impedance	40 k Ω , unbalanced / 1 M Ω
Input capacitance	Switchable
Setting range for input sensitivity	60 dB, adjustable in 3 dB steps

Overall device

Temperature range	-10 °C to +55 °C
Power supply	2 AA batteries, 1.5 V or BA 2015 accupack
Nominal voltage	3 V battery / 2.4 V rechargeable battery
Current consumption	at nominal voltage: typ. 180 mA with transmitter switched off: ≤ 25 μ A
Operating time	Typically 8 h
Dimensions	Approx. 82 x 64 x 24 mm
Weight (incl. batteries)	approx. 160 g



evolution wireless G4

ew 100 G4-ME2/835-S | Combo Set

SPECIFICATIONS

SKM 100 G4-S

RF characteristics	
Modulation	Wideband FM
Frequency ranges	A1: 470 - 516 MHz A: 516 - 558 MHz A10: 516 - 558 MHz AS: 520 - 558 MHz G: 566 - 608 MHz GB: 606 - 648 MHz B: 626 - 668 MHz B10: 626 - 668 MHz C: 734 - 776 MHz D: 780 - 822 MHz JB: 806 - 810 MHz E: 823 - 865 MHz K+: 925 - 937,5 MHz 1G8: 1785 - 1800 MHz
Transmission frequencies	Max. 1680 receiving frequencies, adjustable in 25 kHz steps 20 frequency banks, each with up to 12 factory-preset channels, no intermodulation 1 frequency bank with up to 12 programmable channels
Switching bandwidth	up to 42 MHz
Nominal/peak deviation	± 24 kHz / ± 48 kHz
Frequency stability	$\leq \pm 15$ ppm
RF output power at 50 Ω	Max. 30 mW
Pilot tone squelch	Can be switched off

AF characteristics

Compander system	Sennheiser HDX
AF frequency response	80 - 18,000 Hz
Signal-to-noise ratio (1 mV, peak deviation)	≥ 110 dBA
Total harmonic distortion (THD)	≤ 0.9 %
Max. input voltage	3 V _{eff}
Input impedance	40 k Ω
Input capacitance	Switchable
Setting range for input sensitivity	48 dB, adjustable in 6 dB steps

Overall device

Temperature range	-10 °C to +55 °C
Power supply	2 AA batteries, 1.5 V or BA 2015 accupack
Nominal voltage	3 V battery / 2.4 V rechargeable battery
Current consumption	at nominal voltage: typ. 180 mA with transmitter switched off: ≤ 25 μ A
Operating time	Typically 8 h
Dimensions	Approx. \varnothing 50 x 265 mm
Weight (incl. batteries)	approx. 450 g

SPECIFICATIONS

MMD 835-1

Transducer principle	dynamic
Sensitivity	2.1 mV/Pa
Sound pressure level	154 dB SPL
Pick-up pattern	cardioid



evolution wireless G4

ew 100 G4-ME2/835-S | Combo Set

PRODUCT VARIANTS

ew 100 G4-ME2-835-S-A1	470 - 516 MHz	Art. no. 509745
ew 100 G4-ME2-835-S-A	516 - 558 MHz	Art. no. 509746
ew 100 G4-ME2-835-S-AS	520 - 558 MHz	Art. no. 507924
ew 100 G4-ME2-835-S-G	566 - 608 MHz	Art. no. 509747
ew 100 G4-ME2-835-S-GB	606 - 648 MHz	Art. no. 509965
ew 100 G4-ME2-835-S-B	626 - 668 MHz	Art. no. 509748
ew 100 G4-ME2-835-S-C	734 - 776 MHz	Art. no. 509812
ew 100 G4-ME2-835-S-D	780 - 822 MHz	Art. no. 509813
ew 100 G4-ME2-835-S-E	823 - 865 MHz	Art. no. 509987
ew 100 G4-ME2-835-S-1G8	1785 - 1800 MHz	Art. no. 509966



evolution wireless G4

ew 100 G4-ME2/835-S | Combo Set

DIMENSIONS

EM 100 G4

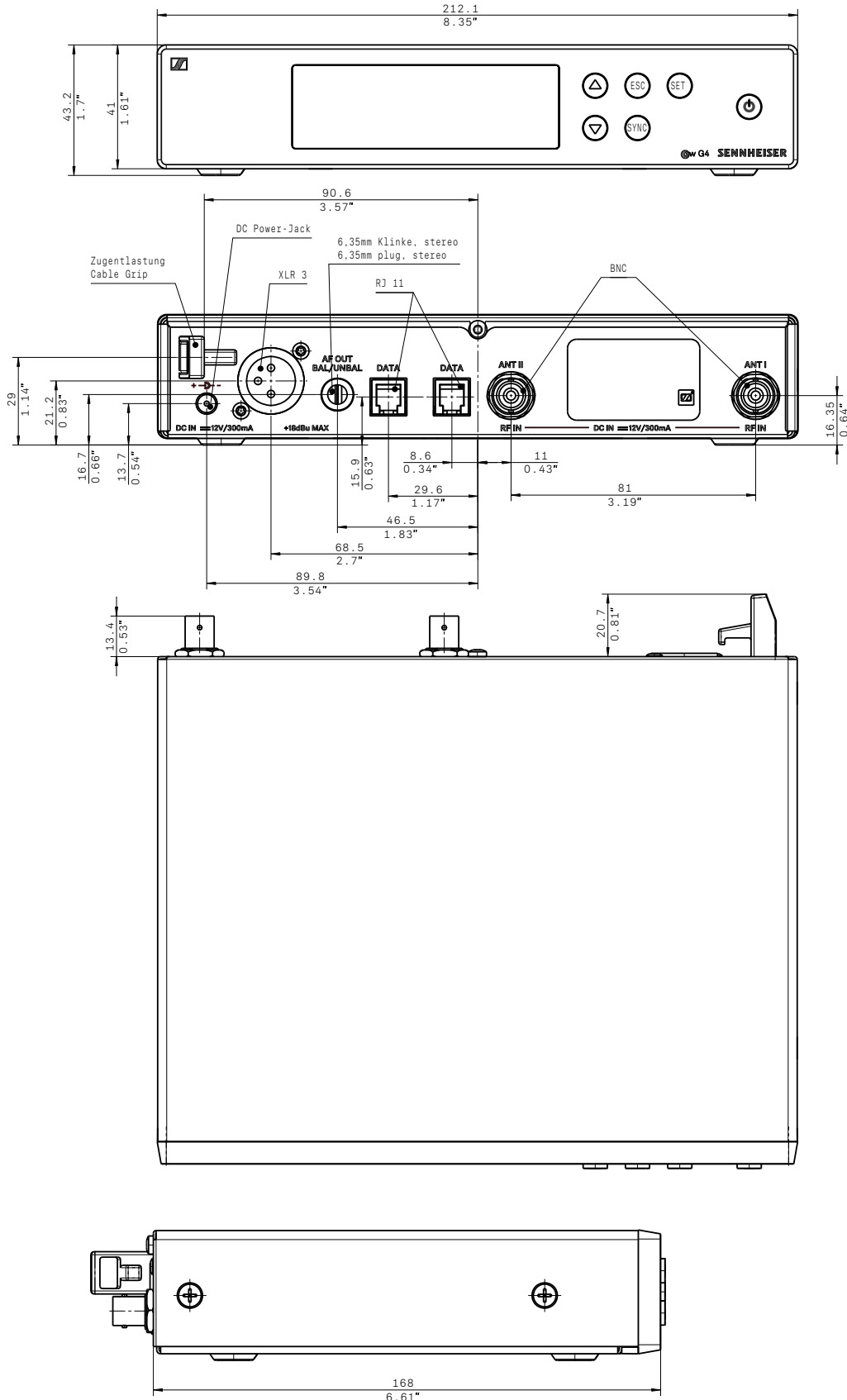



evolution wireless G4

ew 100 G4-ME2/835-S | Combo Set

DIMENSIONS

SK 100 G4

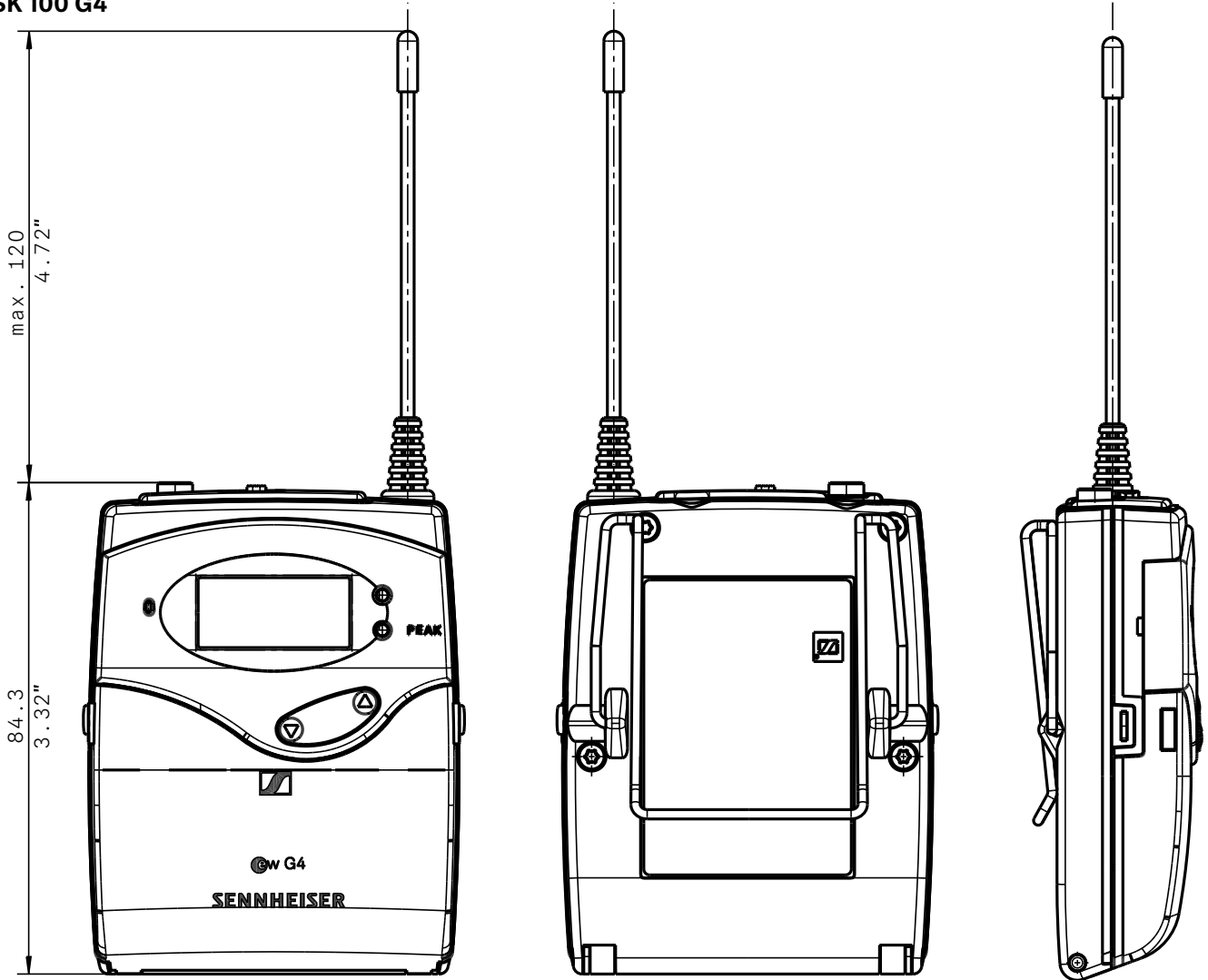

3,5mm Klinke
3,5mm plug

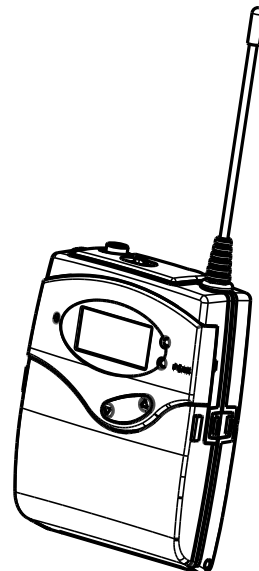
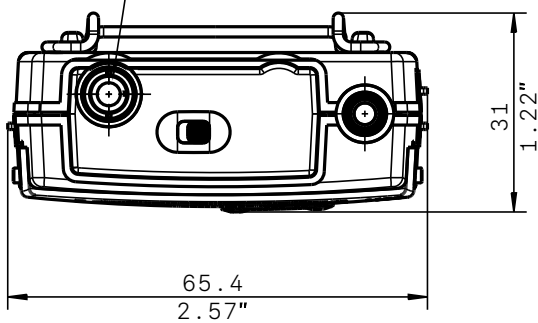



evolution wireless G4

ew 100 G4-ME2/835-S | Combo Set

DIMENSIONS

SKM 100 G4-S

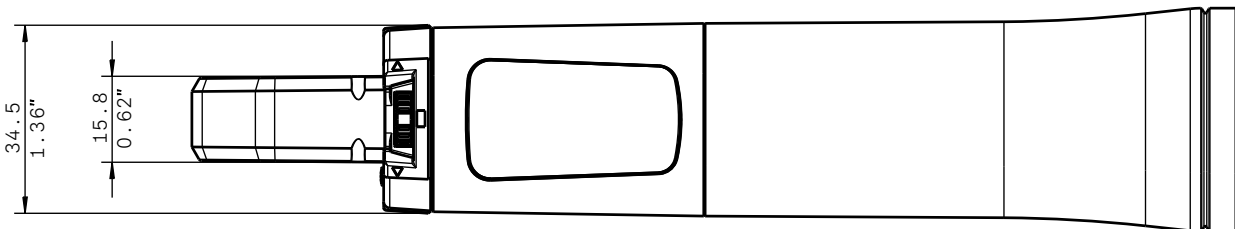
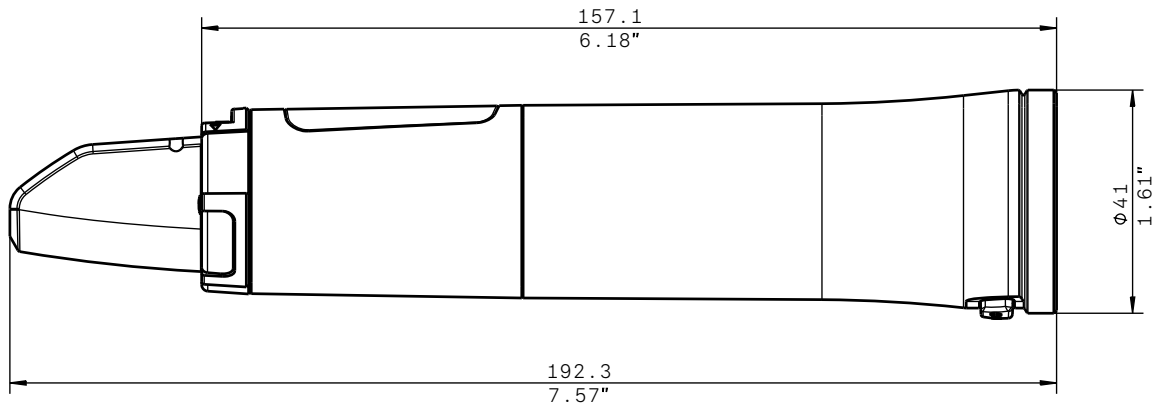
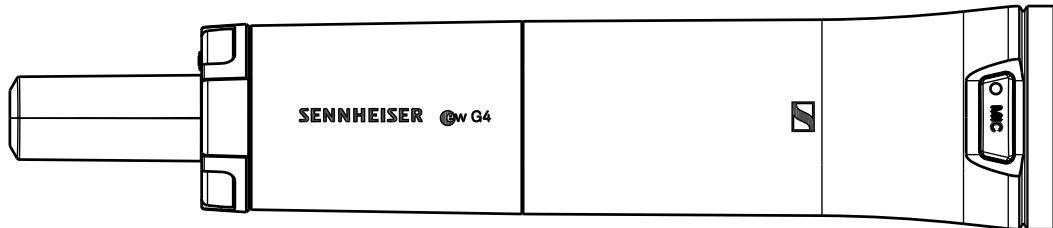



evolution wireless G4

ew 100 G4-ME2/835-S | Combo Set

ARCHITECT'S SPECIFICATION

A wireless RF transmission system consisting of a stationary receiver, a bodypack transmitter with a clip-on microphone and a radio microphone with a cardioid dynamic microphone head.

The system shall operate within twelve UHF frequency ranges, with a switching bandwidth of up to 42 MHz: 470 – 516 MHz, 516 – 558 MHz, 520 – 558 MHz, 566 – 608 MHz, 606 – 648 MHz, 626 – 668 MHz, 734 – 776 MHz, 780 – 822 MHz, 823 – 865 MHz, 806 – 810 MHz, 925 – 937.5 MHz, 1785 – 1800 MHz; receiving frequencies shall be 1,680 per range and shall be tunable in 25 kHz steps. The system shall feature 20 fixed frequency banks with up to 12 compatible frequency presets and 1 user bank with up to 12 user programmable frequencies.

The receiver shall be menu-driven with a backlit LC display showing the current frequency, frequency bank and channel number, metering of RF level, metering of AF level, lock status, pilot tone evaluation, muting function, and battery status of the associated transmitter. An auto-lock feature shall be provided to prevent settings from being accidentally altered. The receiver shall feature an integrated guitar tuner and shall provide a sound check mode.

Some receiver parameters such as receiving frequency, receiver name and pilot tone setting shall be synchronizable with the associated transmitter via an integrated infrared interface.

The receiver shall feature a balanced XLR-3M audio output with a maximum output of +18 dBu along with an unbalanced ¼" (6.3 mm) audio output with a maximum output of +12 dBu. The receiver shall have two DATA ports (RJ 10) to set up a multichannel system. Two BNC-type input sockets shall be provided for connecting the antennas.

Nominal/peak deviation shall be ± 24 kHz/ ± 48 kHz. Squelch threshold shall be adjustable to three levels: Low (5 dB μ V), Middle (15 dB μ V) and High (25 dB μ V).

The receiver shall incorporate the Sennheiser HDX compander system and a defeatable pilot tone squelch. Sensitivity shall be < 2 μ V for 52 dBA eff S/N with HDX engaged at peak deviation. Adjacent channel rejection shall be ≥ 65 dB (typical). Intermodulation attenuation shall be ≥ 65 dB (typical); blocking shall be ≥ 70 dB. Four selectable equalizer presets shall be provided: "Flat", "Low Cut" (-3 dB at 180 Hz), "Low Cut/High Boost" (-3 dB at 180 Hz/+6 dB at 10 kHz) and "High Boost" (+6 dB at 10 kHz).

Signal-to-noise ratio at 1 mV and peak deviation shall be ≥ 110 dBA. Total harmonic distortion (THD) shall be ≤ 0.9 %. The audio output level shall be adjustable within a 48 dB range in steps of 3 dB.

The receiver shall operate on 12 V power supplied from the NT 2-3 CW mains unit (for 100 – 240 V AC, 50/60 Hz). Power consumption shall be 300 mA. The receiver shall have a rugged metal housing; dimensions shall be approximately 190 x 212 x 43 mm (7.48" x 8.35" x 1.69"). Weight shall be approximately 980 grams (2.16 lbs). Operating temperature shall range from -10 °C to $+55$ °C ($+14$ °F to $+131$ °F).

The receiver shall be the Sennheiser EM 100 G4.

The bodypack transmitter shall be menu-driven with a backlit LC display showing the current frequency, frequency bank and channel number, metering of AF level, transmission status, lock status, pilot tone transmission, muting function, and battery status. An auto-lock feature shall be provided to prevent settings from being accidentally altered.

The transmitter parameters shall either be configurable in the associated receiver's menu and synchronized with the transmitter via an integrated infrared interface or shall be programmable in the transmitter menu.

The transmitter shall be equipped with a mute switch, which shall be switchable between "AF on/off", "RF on/off" and "Disabled" via the user interface.

Nominal/peak deviation shall be ± 24 kHz/ ± 48 kHz. Frequency stability shall be $\leq \pm 15$ ppm. RF output power at 50 Ω shall be 30 mW (typical).

The transmitter shall incorporate the Sennheiser HDX compander system and a defeatable pilot tone squelch. Audio frequency response shall range from 80 – 18,000 Hz (microphone) or 25 – 18,000 Hz (line). Signal-to-noise ratio at 1 mV and peak deviation shall be ≥ 110 dBA. Total harmonic distortion (THD) shall be ≤ 0.9 %. Input sensitivity shall be adjustable within a 60 dB range in steps of 3 dB.

Power shall be supplied to the transmitter by two 1.5 V AA size batteries or by one Sennheiser BA 2015 rechargeable accupack. Nominal voltage shall be 2.4 V for a rechargeable battery or 3 V for a battery, current consumption shall be typical 180 mA at nominal voltage; ≤ 25 μ A when transmitter is switched off. Operating time shall be typical 8 hours. The transmitter shall have a rugged metal housing; dimensions shall be approximately 82 x 64 x 24 mm (3.23" x 2.52" x 0.94"). Weight including the batteries shall be approximately 160 grams (0.35 lbs). Operating temperature shall range from -10 °C to $+55$ °C ($+14$ °F to $+131$ °F).

The bodypack transmitter shall be the Sennheiser SK 100 G4.



evolution wireless G4 ew 100 G4-ME2/835-S | Combo Set

The radio microphone shall be menu-driven with a backlit LC display showing the current frequency, frequency bank and channel number, metering of AF level, transmission status, lock status, pilot tone transmission, muting function, and battery status. An auto-lock feature shall be provided to prevent settings from being accidentally altered.

The radio microphone parameters shall either be configurable in the associated receiver's menu and synchronized with the radio microphone via an integrated infrared interface or shall be programmable in the radio microphone menu. Receiver parameters such as receiving frequency, receiver name and pilot tone setting shall be synchronizable with the radio microphone via an integrated infrared interface.

The handheld vocal radio microphone shall be equipped with a mute switch, which shall be switchable between "AF on/off", "RF on/off" and "Disabled" via the user interface.

Nominal/peak deviation shall be ± 24 kHz/ ± 48 kHz. Frequency stability shall be $\leq \pm 15$ ppm. RF output power at 50 Ω shall be 30 mW (typical).

The radio microphone shall incorporate the Sennheiser HDX compander system and a defeatable pilot tone squelch. Audio frequency response shall range from 80 – 18,000 Hz. Signal-to-noise ratio at 1 mV and peak deviation shall be ≥ 110 dBA. Total harmonic distortion (THD) shall be ≤ 0.9 %. Input sensitivity shall be adjustable within a 48 dB range in steps of 6 dB.

Power shall be supplied to the radio microphone by two 1.5 V AA size batteries or by one Sennheiser BA 2015 rechargeable accupack. Nominal voltage shall be 2.4 V, current consumption shall be typical 180 mA at nominal voltage; ≤ 25 μ A when radio microphone is switched off. Operating time shall be typical 8 hours. The radio microphone shall have a rugged metal housing; dimensions shall be approximately 50 mm (1.97") in diameter and 265 mm (10.43") in length. Weight including the batteries shall be approximately 450 grams (0.99 lbs). Operating temperature shall range from -10 °C to $+55$ °C ($+14$ °F to $+131$ °F).

A range of microphone heads shall be available for the radio microphone.

The radio microphone shall be the Sennheiser SKM 100-S G4.