

Tourguide 1039



Contents

- Important safety instructions2**
- The Tourguide 1039 system4**
 - Frequency ranges4
 - Features of the EK 1039 receiver4
 - Suitable transmitters for your Tourguide application5
 - Charger for your Tourguide application7
- Product overview of the EK 1039 receiver8**
- Putting the receiver into operation10**
 - Inserting the batteries or the accupack10
 - Charging the accupack10
 - Connecting headphones10
- Using the receiver11**
 - Switching the diversity receiver on/off and adjusting the volume11
 - Deactivating the lock mode temporarily12
 - Setting the receiving channel12
 - Attaching the receiver to clothing13
- Configuring the receiver14**
 - Calling up/ending the menu14
 - Overview of the menu15
 - The buttons15
 - Working with the menu16
 - The “Setup” menu17
 - The “Channels” menu19
 - The “Setup Ch 1” ... “Setup Ch 32” menu20
- Cleaning and maintaining the receiver21**
- Configuring the transmitters for your Tourguide application22**
 - Matching the transmitter to the receiver22
 - Configuring the mobile SK, SKM and SKP transmitters22
 - Configuring the stationary SR monitoring transmitter22
- If a problem occurs23**
- Recommendations and tips24**
- Specifications25**
- Appendix27**

Important safety instructions

- Read the instruction manual and the safety guide carefully and completely before using the product.
- Ensure that the instruction manual and safety guide are easily accessible to all users at all times.
- Always include this instruction manual and the safety guide when passing the product on to third parties.
- Only use attachments, accessories and spare parts specified by the manufacturer.
- Do not attempt to open the product housing on your own. The warranty is voided for products opened by the customer.
- Refer all servicing to qualified service personnel. Servicing is required when the product has been damaged in any way, liquid has been spilled or objects have fallen into the product, when the product has been exposed to rain or moisture, does not operate normally, or has been dropped.
- Use the product only under the conditions of use listed in the specifications.
- Do not operate the product if it was damaged during transportation.
- Do not operate the product if it was damaged during transportation.
- Keep the product and its connections away from liquids and electrically conductive objects that are not necessary for operating the product.
- Do not use any solvents or aggressive cleaning agents to clean the product.

Danger of hearing damage due to high volumes

This is a professional receiver. Commercial use is subject to the rules and regulations of the trade association responsible. Sennheiser, as the manufacturer, is therefore obliged to expressly point out possible health risks arising from use.

The EK 1039 receiver is capable of producing sound pressure levels exceeding 85 dB (A). 85 dB (A) is the sound pressure corresponding to the maximum permissible volume which is by law (in some countries) allowed to affect your hearing for the duration of a working day. It is used as a basis according to the specifications of industrial medicine. Higher volumes or longer durations can damage your hearing. At higher volumes, the duration must be shortened in order to prevent hearing damage. The following are sure signs that you have been subjected to excessive noise for too long a time:

- You can hear ringing or whistling sounds in your ears.
- You have the impression (even for a short time only) that you can no longer hear high notes.

Inform the users of your Tourguide application about these facts and, if necessary, ask them to set the volume to a medium level.

Safety instructions for NiMH rechargeable batteries

- Caution: Risk of explosion if you use or replace a battery by an incorrect type.
- Do not short-circuit a cell or battery.
- Do not expose cells or batteries to heat or fire. Avoid storage in sunlight.
- Do not subject cells or batteries to mechanical shock.
- Do not touch leaking/defective batteries unprotected.
- Observe correct polarity.
- Do not use different battery types.
- Charge rechargeable batteries at ambient temperatures between +10 °C and +40 °C (+50 °F and +104 °F).

Intended use

Intended use includes:

- using the products for professional purposes,
- having read and understood this instruction manual, especially the chapter “Important safety instructions” on page 2,
- using the products within the operating conditions and limitations described in this instruction manual.

“Improper use” means using the products other than as described in this instruction manual, or under operating conditions which differ from those described herein.

The Tourguide 1039 system

The Tourguide 1039 system consists of the EK 1039 receiver and a suitable transmitter of the evolution wireless G3, G4 or 2000 series.

The system offers optimum speech transmission for guided tours, small conferences and interpretation applications with one or several speakers.

The use of RF transmission allows freedom of movement for all members of the group. Due to the possibility of combining the EK 1039 receiver with different transmitters, the system can be optimally adapted to your individual needs.

Frequency ranges

The EK 1039 receiver is available in the frequency ranges Aw+, Gw, Bw, Cw and Dw. For setting up a transmission link, the evolution wireless G3, G4 or 2000 (including IEM) series transmitter used must operate in a matching frequency range and must be set to the same frequency as the receiver (see www.sennheiser.com/frequency-information).

32 factory-preset frequencies that are intermodulation-free allow you to operate up to 32 transmission links simultaneously.

You can change the factory-preset frequencies to suit your needs. In this case, however, it might be that the frequencies are not intermodulation-free.

Features of the EK 1039 receiver



EK 1039







The EK 1039 is a small, rugged bodypack receiver that can easily be attached to clothing by means of a belt clip. The receiver allows you to connect any headphones (min. 8 Ω) and to individually adjust the volume. 32 UHF receiving frequencies (preset but changeable) offer high flexibility and adaptability.

Features of the receiver:

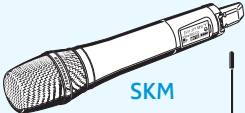
- Easy and comfortable use
- Channel indication with individual channel name via display
- Channel adjustment via rocker button
- Operation and reception indication via LED
- “LowBattery” indication via LED and display

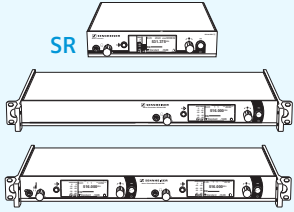
Suitable transmitters for your Tourguide application

The following table will help you to select a suitable transmitter for your Tourguide application.

Receiver	Transmitters	
	Mobile use	Stationary use
Tourguide 1039: • EK 1039	evolution wireless G3 or G4 series: • SKs • SKMs • SKPs 2000 series: • SK • SKM • SKP	evolution wireless G3 or G4 series: • SRs IEM 2000 series: • SRs IEM
 <p>EK 1039</p>	 <p>SKM</p>  <p>SKP</p>  <p>SK</p>	 <p>SR</p>   

All mentioned transmitters of the evolution wireless G3, G4 or 2000 series are available in frequency ranges that are compatible with the frequency ranges of the EK 1039 receivers (see page 4).

Mobile use of the transmitters

SK bodypack transmitter

A portable bodypack transmitter allows the connection of a clip-on microphone or a headmic so that the tour guide has both hands free and complete freedom of movement while guiding the group.

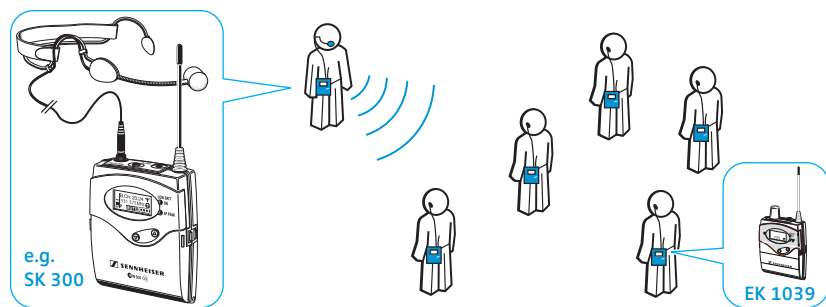

SKM radio microphone

A radio microphone can be passed on from the tour guide to members of the group, e.g. when questions arise during the guided tour.

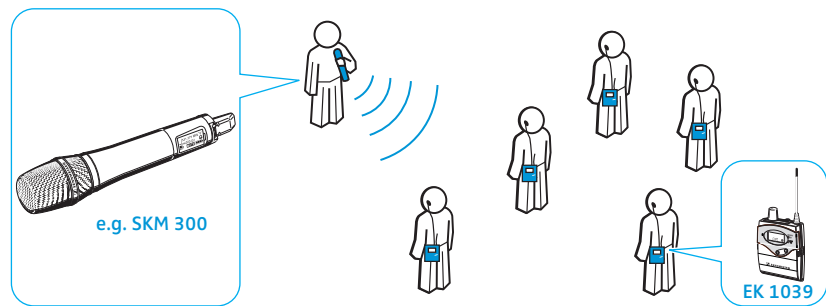

SKP plug-on transmitter

A plug-on transmitter converts a wired microphone into a radio microphone, allowing e.g. to use an existing microphone for your mobile Tourguide application.

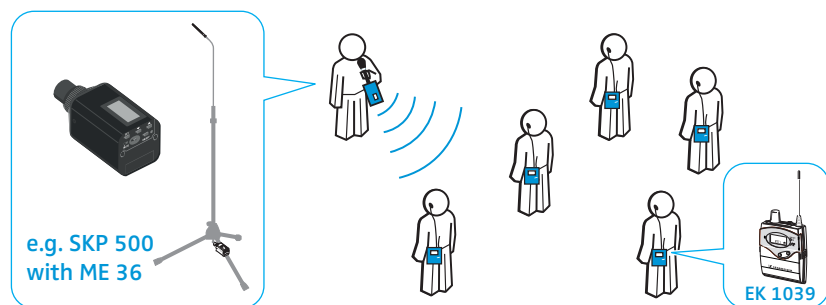

Stationary use of the transmitters

SR monitoring transmitter

You can use a stationary transmitter for e.g. running a small conference or for offering a translation of the audio channel. The transmitter can be connected to a mixing console and to other audio sources.

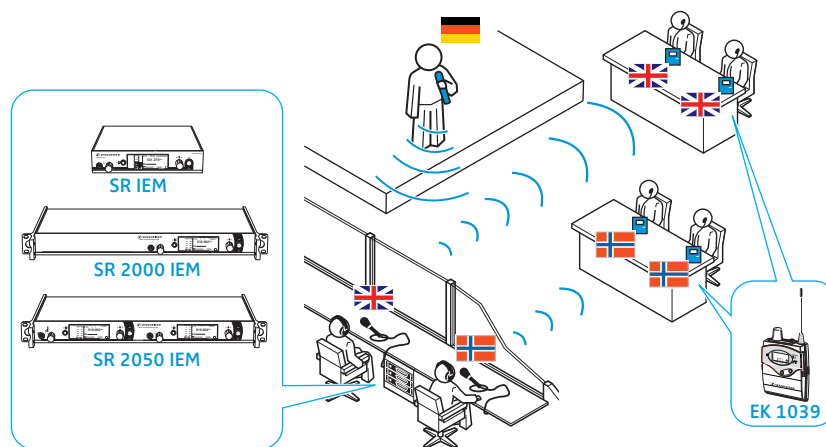

Charger for your Tourguide application

BA 2015 accupack

For daily use, we recommend using the supplied BA 2015 accupack. The accupack can be charged in the L 2015 charger without having to be removed from the device.

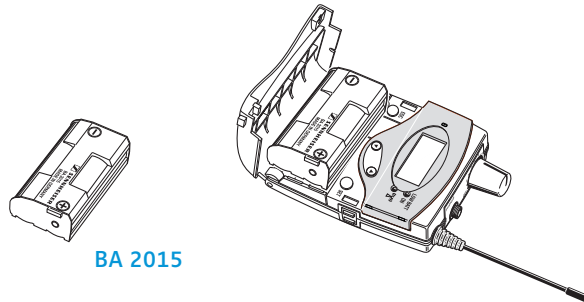

BA 2015

L 2015 charger

The L 2015 charger can charge up to two BA 2015 accupacks. The accupacks can be charged separately or when installed in the receiver.

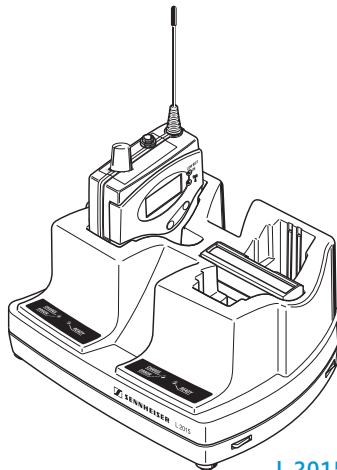

L 2015

Product overview of the EK 1039 receiver

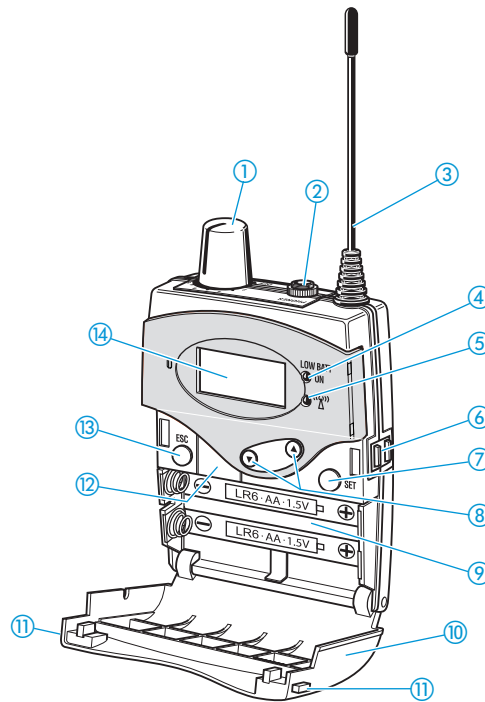



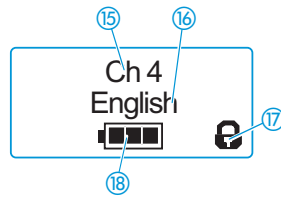

- ① On/off/volume control
- ② 3.5 mm jack socket for headphones, lockable
- ③ Receiving antenna
- ④ Operation and battery status indicator "LOW BATT/ON", red LED:
lit = ON
flashing = LOW BATT
- ⑤ RF signal indication, green LED
- ⑥ Charging contacts
- ⑦ SET button
- ⑧ ▲/▼ button (UP/DOWN)
- ⑨ Battery compartment
- ⑩ Battery compartment cover (metal)
- ⑪ Battery compartment catches
- ⑫ Infra-red interface
- ⑬ ESC button
- ⑭ Display panel, backlit in orange

Overview of the displays

After switch-on, the receiver displays the standard display:

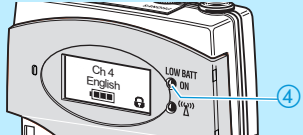

The display backlighting is automatically reduced after approx. 20 seconds.

Display	Meaning
15 Receiving channel	Current receiving channel “Ch 1” ... “Ch 32”
16 Channel name	Name of the receiving channel, individually adjustable; can consist of 8 characters max., e.g. “English”
17 Lock mode icon	Lock mode is activated (see page 12)
18 Charge status of the BA 2015 accupack/batteries	<p>Charge status:</p> <ul style="list-style-type: none">  approx. 100%  approx. 70%  approx. 30%  critical charge status, the red LOW BATT LED 4 is flashing: 

When you call up the menu for configuring the receiver (see page 14), the receiver’s display panel shows the Setup display:



Putting the receiver into operation

Inserting the batteries or the accupack

For powering the diversity receiver, you can either use two 1.5 V AA size batteries or the rechargeable Sennheiser BA 2015 accupack.

For daily use, we recommend using the supplied BA 2015 accupack. The accupack can be charged in the L 2015 charger without having to be removed from the device.

- ▶ Open the battery compartment by pushing the two catches (11) in the direction of the arrows and open the cover (10).

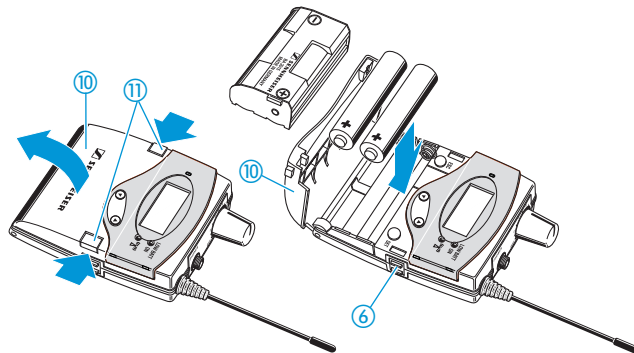

- ▶ Insert the BA 2015 accupack or the two batteries as shown above. Please observe correct polarity when inserting the accupack/batteries.
- ▶ Close the battery compartment by pressing on the center of the cover (10). The battery compartment cover (10) locks into place with an audible click.

Charging the accupack

To charge the BA 2015 accupack installed in the receiver:

- ▶ Insert the diversity receiver into the L 2015 charger. The receiver switches off and the accupack is being charged.

For more information on charging the BA 2015 accupack, refer to the instruction manual for the L 2015 charger.

i Never switch on the receiver during charging because otherwise the accupack will not be charged correctly.

The L 2015 charger can only charge the BA 2015 accupack. Standard batteries (primary cells) installed in the receiver or individual rechargeable battery cells cannot be charged.

Connecting headphones

- ▶ Connect headphones with an impedance of at least 8 Ω to the 3.5 mm jack socket (2).

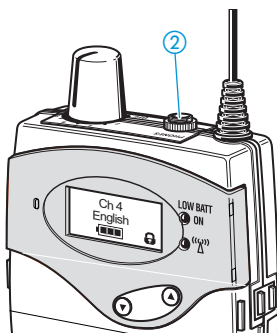

Using the receiver

To establish a transmission link between the configured transmitter and receiver, proceed as follows:

1. Switch the receiver on (see next section).
2. Switch the transmitter on (see the instruction manual for the transmitter).
The transmission link is established and the receiver's RF signal indication ⑤ lights up green.



For information on how to configure the receiver, read the chapter "Configuring the receiver" on page 14.

For information on how to configure the transmitter, read the chapter "Configuring the transmitters for your Tourguide application" on page 22 and the instruction manual for the transmitter used.

If you cannot establish a transmission link between transmitter and receiver, read the chapter "If a problem occurs ..." on page 23.

Switching the diversity receiver on/off and adjusting the volume

After switch-on, the receiver displays the standard display which allows the user to switch between the receiving channels (see page 12).

You can configure the receiver via the Setup menu which you can access using a special key combination during switch-on (see page 14).

To switch the receiver **on**:

- ▶ Turn the volume control ① clockwise until it clicks.
The red LED **ON** ④ lights up. The standard display appears on the display panel.

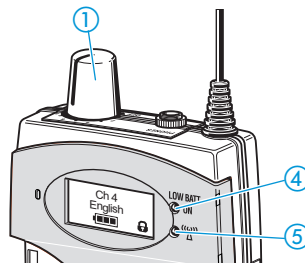

To switch the receiver **off**:

- ▶ Turn the volume control ① counterclockwise until it clicks.
The red LED **ON** ④ goes off and the receiver switches off.



When not using the receiver for extended periods of time, remove the accupack/batteries.

When you insert a switched-on receiver into the L 2015 charger, the receiver automatically switches off. The receiver remains switched off when you take it from the charger after charging. You first have to turn the volume control ① counterclockwise until it clicks to be able to switch the receiver on (turn the volume control ① clockwise until it clicks).

To adjust the **volume**:



WARNING

Hearing damage due to high volumes!

Listening at high volume levels for long periods can lead to permanent hearing defects.

- ▶ Set the volume to a low level before using the product.
- ▶ Do **not** continuously expose yourself to high volumes.

- ▶ Turn the volume control ①
 - clockwise to increase the volume
 - counterclockwise to reduce the volume.



Using the “**Limiter**” function, you can reduce the audio level of the headphone output (see page 18).

Deactivating the lock mode temporarily

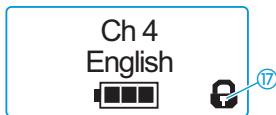

If the automatic lock mode “**Auto Lock**” is activated (see page 17), you have to temporarily deactivate it in order to be able to operate the receiver:

- ▶ Press the **SET** button.
 - “**Locked**” appears on the display pane.
- ▶ Press the rocker button.
 - “**Unlock?**” appears on the display panel.
- ▶ Press the **SET** button.
 - The lock mode is deactivated.

The lock mode icon ⑰ flashes prior to the lock mode being activated again (if no button has been pressed for approx. 10 seconds).

Setting the receiving channel

If several guided tours take place within a building at the same time, i.e. several transmission links are operated simultaneously, the user can switch the channel of the receiver to the channel that is stated by the tour guide.

To switch between the receiving channels:

- ▶ Press the rocker button.
 - The receiver immediately switches to the new receiving channel. If the receiver receives a transmitter on the new channel, the green LED ⑤ lights up.



The “**Active**” function allows you to show or hide the receiving channels from the standard display (see page 21).

Attaching the receiver to clothing

You can use the belt clip 15 to attach the diversity receiver to clothing (e.g. belt, waistband).

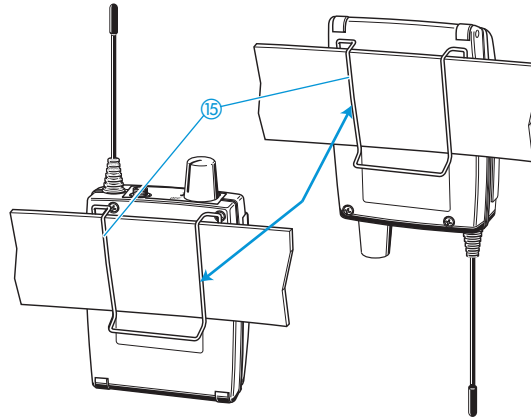

The belt clip is detachable so that you can also attach the receiver with the antenna pointing downwards. To do so, withdraw the belt clip from its fixing points and attach it the other way round. The belt clip is secured so that it cannot slide out of its fixing points accidentally.

To detach the belt clip:

- ▶ Lift one side of the belt clip as shown in the diagram.

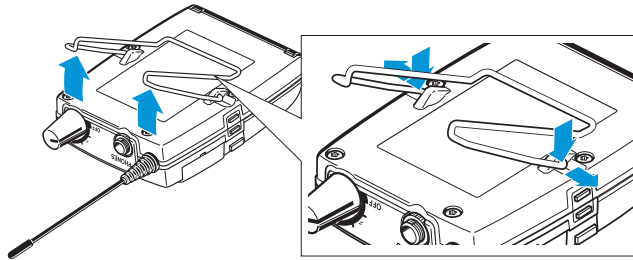

- ▶ Press down the belt clip at one fixing point and pull it out of the receiver housing.
- ▶ Repeat for the other side.

Configuring the receiver

Calling up/ending the menu

You can only call up the menu when the receiver is switched off.

- ▶ Press the **ESC** button (13) and keep it pressed.
- ▶ Turn the volume control (1) clockwise until it clicks to switch the receiver on.
The Setup display appears on the display panel.

To end the menu:

- ▶ Switch the receiver off (see page 11).
When switching the receiver on again, the standard display will be shown.

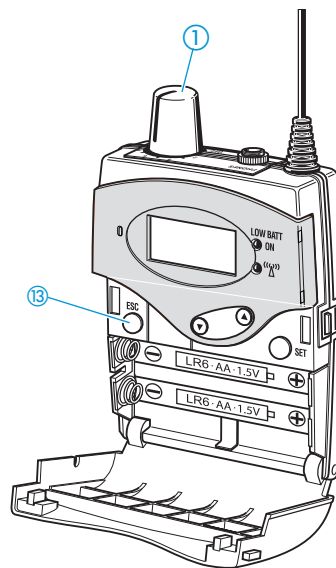

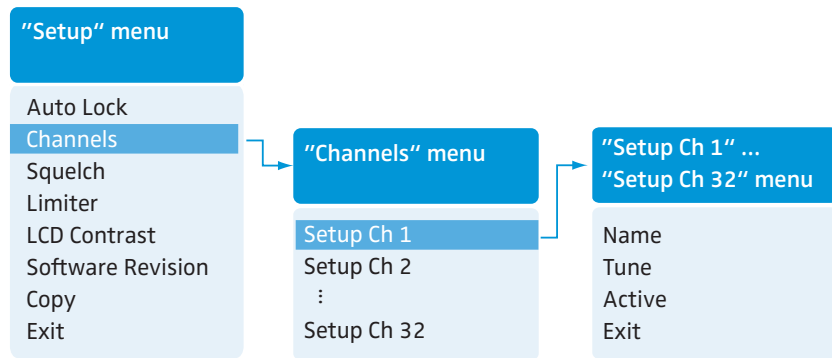

Overview of the menu



Display	Function of the menu item	Page
'Setup' menu		
Auto Lock	Activates the automatic lock mode	17
Channels	Call up the "Channels" menu	19
Squelch	Adjusts the squelch threshold	17
Limiter	Activating the limiter of the headphone output	18
LCD Contrast	Adjusts the contrast of the display panel	18
Software Revision	Displays the current software version	18
Copy	Copies receiver settings to additional receivers	19
Exit	Exits the menu and returns to the Setup display	-
'Channels' menu		
Setup Ch 1 ... Setup Ch 32	Calls up the "Setup Ch 1" ... "Setup Ch 32" menu	19
'Setup Ch 1' ... 'Setup Ch 32' menu		
Name	Enters a freely selectable name for the channel	20
Tune	Changes the receiving frequencies of the channels	20
Active	Hides the receiving channel for the user	21
Exit	Exits the "Setup Ch 1" ... "Setup Ch 32" menu and returns to the "Channels" menu	-

The buttons

Button	Function of the button
Press the ESC button 	<ul style="list-style-type: none"> • Cancels the entry and returns to the Setup display (ESC function)

Button	Function of the button
Press the SET button 	<ul style="list-style-type: none"> • Changes from the Setup display to the menu • Calls up a menu item • Enters a submenu • Stores the settings
Press the rocker button 	<ul style="list-style-type: none"> • Changes to the next/previous menu item • Changes the setting of a menu item

Working with the menu

By way of example of the “**Limit**er” menu item, this section describes how to use the menu.

Calling up the menu

-  Press the **SET** button. You call up the menu.

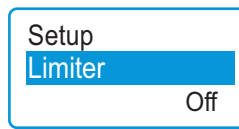

Selecting a menu item

-  Press the rocker button to change to the “**Limit**er” menu item. The current setting of the menu item is displayed:

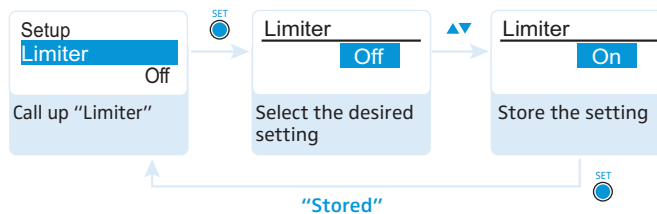

Calling up a menu item and adjusting and storing it



-  Press the **SET** button to call up the menu item.
-  Press the rocker button to adjust the “**Limit**er” setting.
-  Press the **SET** button to store the setting.

Canceling an entry

-  Press the **ESC** button to cancel the entry. The Setup display appears on the display panel.

To subsequently return to the last edited menu item:

-  Press the **SET** button repeatedly until the last edited menu item appears.

Returning to the next higher menu level or exiting the menu

To return to the next higher menu level:

- ▼▲ ▶ Change to the “Exit” menu item.

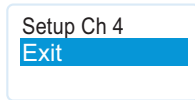

- SET ▶ Confirm your selection. You return to the next higher menu level or exit the menu.

To directly return to the Setup display:

- ESC ▶ Press the ESC button.

The “Setup” menu

Activating the automatic lock mode – “Auto Lock”

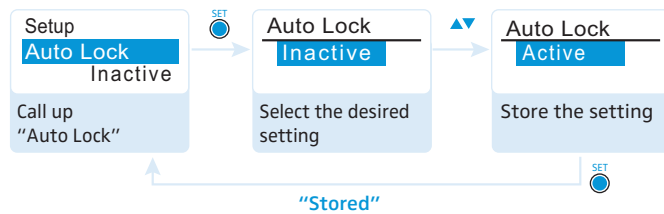

Possible settings: “Active”, “Inactive”

The automatic lock mode prevents that the receiving channel is accidentally changed on the receiver. The lock mode icon 17 on the standard display indicates that the lock mode is activated.

For information on how to deactivate the lock mode, refer to page 12.

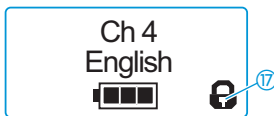

Adjusting the squelch threshold – “Squelch”

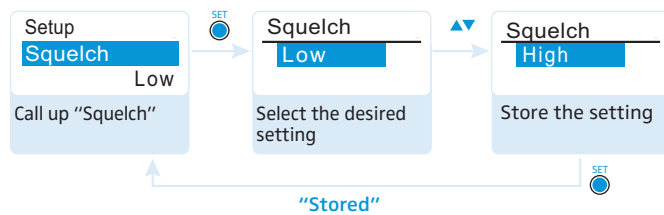

Possible settings: “Low”, “Middle”, “High”, “Off”

The squelch eliminates annoying noise when the transmitter is switched off or when there is no longer sufficient transmitter power received by the receiver.



WARNING

Danger of hearing damage!

If you switch the squelch off or adjust the squelch threshold to a very low value, loud hissing noise can occur in the receiver. The hissing noise can be loud enough to cause hearing damage!

- ▶ Always make sure that the squelch is switched on.
- ▶ Before adjusting the squelch threshold, set the volume of the headphone output to the minimum (see page 11).
- ▶ Never change the squelch threshold during a guided tour.
- ▶ Only switch off the squelch for servicing or test purposes.

- ▶ Adjust the squelch threshold – with the transmitter switched off – to the lowest possible setting that suppresses hissing noise.



A high squelch threshold reduces the transmission range.

The squelch should only be switched off for servicing or test purposes. With the squelch threshold set to “Low”, you switch the squelch off by keeping the DOWN rocker button pressed for 3 seconds.

Activating the limiter of the headphone output – “Limiter”



Possible settings: “On”, “Off”

The limiter reduces the maximum volume at the headphone output by –12 dB.



Upon delivery, the “Limiter” function is switched on. We recommend to keep this function switched on at all times.

Adjusting the contrast of the display panel – “LCD Contrast”

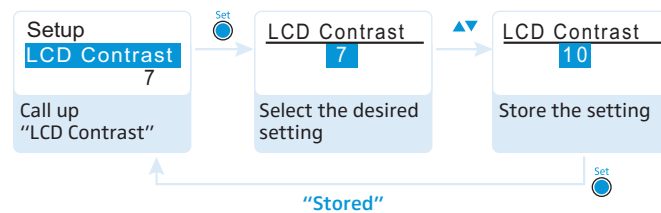

You can adjust the contrast of the display panel in 16 steps.

Displaying the software version – “Software Revision”

You can display the current software version of the receiver.

- ▶ For information on software updates, visit the EK 1039 product page at www.sennheiser.com.

Copying the receiver settings to additional receivers – “Copy”

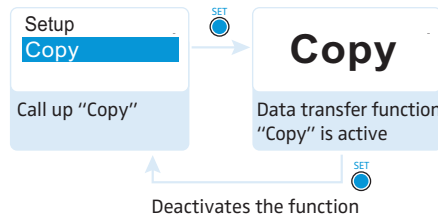

Via the “Copy” menu item, you can copy all settings of one receiver (A) to an arbitrary number of other EK 1039 receivers (B). This allows you to quickly and easily transfer e.g. a new receiving channel to all other receivers in the system.

To prepare the receiver (A) to transfer the settings:

- ▶ Select a receiver.
- ▶ Set the desired receiving channel, the name, the squelch threshold, etc.
- ▶ Change to the “Copy” menu item.
All settings of this receiver (A) will be transferred to the other receivers (B).

To prepare the receivers (B) to receive the settings:

- ▶ Open the battery compartment cover of all receivers (B) to which you want to transfer the settings.
- ▶ Switch on all receivers.

To copy the settings:

- ▶ Place the receiver (A) above the infra-red interfaces ⑫ of the other receivers (B), one after the other. The distance between the infra-red interfaces must not exceed 10 cm.
The settings are copied and “Copy” briefly appears on the display panels of the receivers (B). If data transfer was successful, the receiver (B) switches off automatically.

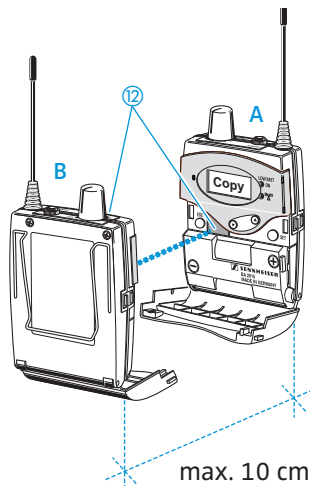

i Strong extraneous light may interfere with the data transfer via the infra-red interface. Therefore, position the receivers so that any possible interference caused by extraneous light is avoided. The blue line between the infra-red interfaces ⑫ in the diagram on the left indicates the direction from which the IR radiation must impinge upon the receiver.

i If you are using receivers from different frequency ranges and if you have set a frequency that is not available in the frequency range of the receiver (B), “Incompatible Frequency” appears on the display panel.

- ▶ Use receivers from the same frequency range or set a frequency that is available in both frequency ranges.

The “Channels” menu

Calling up the “Setup Ch 1” ... “Setup Ch 32” menu

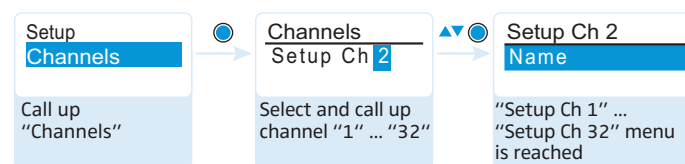

Via the “Channels” menu, you can call up the “Setup Ch 1” ... “Setup Ch 32” submenu.

The “Setup Ch 1” ... “Setup Ch 32” menu

Entering a name – “Name”

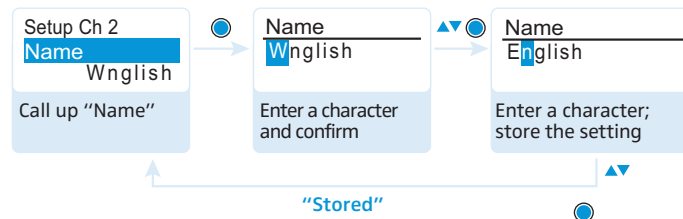

Via the “Name” menu, you can enter a freely selectable name for the receiving channel (e.g. the language of the guided tour). The name is displayed on the standard display and can consist of up to 8 characters such as:

- letters (without pronunciation marks),
- numbers from 0 to 9,
- special characters and spaces.

To enter a name, proceed as follows:

- ▼▲ ▶ Press the rocker button to select a character.
- SET ▶ Press the SET button to change to the next segment/character or to store the complete entry.

Changing the receiving frequencies of the channels – “Tune”

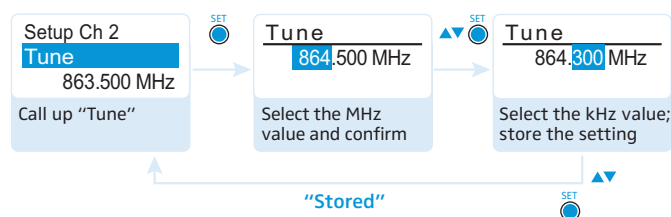

i It is vital to observe the notes on frequency selection in the chapter “Matching the transmitter to the receiver” on page 22.

Via the “Tune” menu item, you can change the receiving frequency of a channel.

The receiver’s channels have been factory-preset to receiving frequencies that are intermodulation-free. However, you can change the factory-preset frequencies. Within one frequency range, up to 32 transmission links can be operated simultaneously.

To change the receiving frequency of the channel:

- ▼▲ ▶ Press the rocker button to adjust the frequency in MHz steps.
- SET ▶ Press the SET button to confirm the MHz setting of the frequency.
The kHz section of the frequency is highlighted.
- ▼▲ ▶ Press the rocker button to adjust the frequency in 25 kHz steps.
- SET ▶ Press the SET button to store the setting.
“Stored” appears on the display panel.

Adjusting the visibility of the receiving channel – “Active”

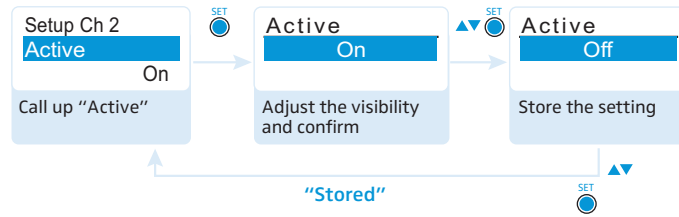

Possible settings: activated and visible “On”, deactivated and hidden “Off”

Via the “Active” menu item, you can show or hide the receiving channel. An activated channel is visible on the standard display and can be selected. A deactivated channel is invisible on the standard display and cannot be selected.

Cleaning and maintaining the receiver

CAUTION

Liquids can damage the electronics of the product!

Liquids entering the housing of the product can cause a short-circuit and damage the electronics. Solvents or cleansing agents can damage the surface of the product.

- ▶ Keep all liquids away from the product.
- ▶ Do not use any solvents or cleansing agents.
- ▶ Use a dry cloth to clean the product from time to time.

Configuring the transmitters for your Tourguide application



Please also read the instruction manual for your transmitter. It provides important information that ensures safe and optimum operation of the transmitter in your Tourguide application.

Matching the transmitter to the receiver

i To be able to establish a transmission link, the transmitter and receiver used must operate in compatible frequency ranges (see page 4) and must be set to the same frequency.

Make sure that the desired frequencies are approved and legal in your country and, if necessary, apply for an operating license.

You can contact your Sennheiser partner who will be pleased to calculate intermodulation-free frequencies for you or to help you apply for an operating license.

The receiver's channels have been factory-preset to receiving frequencies that are intermodulation-free (see frequency table on page 26). However, you can change the factory-preset frequencies. Within one frequency range, up to 32 transmission links can be operated simultaneously.

- ▶ Make sure to set the transmitter of the evolution wireless G3, G4 or 2000 series to the same frequency as the receiver.

If you still cannot establish a transmission link between transmitter and receiver, read the chapter “If a problem occurs ...” on page 23.

Configuring the mobile SK, SKM and SKP transmitters



1. Set the frequency that you want to use for your Tourguide application (“**Tune**” menu item).
2. Adjust the input sensitivity of the microphone (“**Sensitivity**” menu item; for presentation applications, the guide values range from approx. -21 dB to 0 dB).

Configuring the stationary SR monitoring transmitter

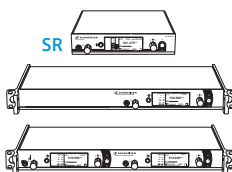

1. Set the frequency that you want to use for your Tourguide application (“**Tune**” menu item).
2. Set the transmitter to mono operation to avoid interference during RF transmission (“**Mode**” menu item).
3. Adjust the input sensitivity of the transmitter (“**Sensitivity**” menu item; for presentation applications, the guide values range from approx. -21 dB to 0 dB).

If a problem occurs ...

Problem	Possible cause	Possible solution
Receiver cannot be operated, “Locked” appears on the display panel	Lock mode is activated	Deactivate the lock mode (see page 12).
No operation indication	Batteries are flat or accupack is flat	Replace the batteries or recharge the accupack (see page 10).
	Batteries are inserted the wrong way round	Observe correct polarity when inserting the batteries (see page 10).
No RF signal	Transmitter and receiver are not on the same channel	Set the receiver and transmitter to the same channel.
	Transmission range is exceeded	Reduce the distance between receiver and transmitter.
		Check the squelch threshold setting and, if necessary, reduce it (see page 17).
		Increase the transmitter’s transmission power (see the instruction manual for the transmitter).
Transmitter’s RF signal is deactivated (“RF Mute”)	Activate the RF signal (see the instruction manual for the transmitter).	
RF signal available, no audio signal	Transmitter is muted (MUTE)	Cancel the muting (see the instruction manual for the transmitter).
	Receiver’s squelch threshold is adjusted too high	Reduce the squelch threshold setting (see page 17).
	Microphone is defective	Replace the microphone.
	Headphones are defective	Replace the headphones.
Audio signal has a high level of background noise	Transmitter sensitivity is adjusted too low	Adjust the transmitter sensitivity correctly (see the instruction manual for the transmitter).
Audio signal is distorted	Transmitter sensitivity is adjusted too high	Adjust the transmitter sensitivity correctly (see the instruction manual for the transmitter).
	Receiver’s audio output level is adjusted too high	Reduce the audio output level (see page 18).
No access to a certain receiving channel	Receiving channel is hidden for the user	Activate the visibility of the receiving channel (“Active”, see page 21).
During copying, “Incompatible Frequency” appears on the display panel	You are using receivers from different frequency ranges and you have set a frequency that is not available in the frequency range of one of the receivers.	Use a receiver from the same frequency range.
		Set a frequency that is available in both frequency ranges.

Please also read the chapter “If a problem occurs ...” in the instruction manual for your transmitter.

If a problem occurs that is not listed in the above table or if the problem cannot be solved with the proposed solutions, please contact your local Sennheiser partner for assistance.

To find a Sennheiser partner in your country, search at www.sennheiser.com under “Service & Support”.

Recommendations and tips

General information

- Transmission range depends to a large extent on location and can vary from about 10 m to about 150 m. There should be a “free line of sight” between transmitter and receiver.
- For best sound quality, make sure that the transmitter sensitivity is correctly adjusted (see the instruction manual for the transmitter).

... for SKM radio microphones and SKP plug-on transmitters

- Hold the radio microphone in the middle of the microphone body. Holding it close to the sound inlet basket will influence the radio microphone’s pick-up pattern, holding it at the lower part of the microphone body will reduce the radiated transmission power and thus the transmission range.
- You can vary the bass reproduction by increasing/decreasing the talking distance.
- For best sound quality, make sure that the transmitter sensitivity is correctly adjusted (see the instruction manual for the transmitter).
- The plug-on transmitter uses the microphone body as an antenna – therefore microphones with a metal casing should be used for best signal transmission.

... for SK bodypack transmitters

- Make sure that the antenna and the microphone cable do not cross.
- The antenna should hang or stand freely and be at least 1 cm away from the body. The antenna must not be in direct contact with the skin.
- For best sound quality, make sure that the transmitter sensitivity is correctly adjusted (see the instruction manual for the transmitter).

... for stationary SR monitoring transmitters

- Only use the monitoring transmitter in mono operation.
- For optimum RF operation, use suitable antennas from the Sennheiser accessory range. For more information on suitable accessories, visit the corresponding product pages at www.sennheiser.com.

Specifications



The specifications of the transmitter can be found in the instruction manual for the transmitter.

EK 1039 receiver

RF characteristics

Modulation	wideband FM
Frequency ranges	Aw+: 470,100-558 MHz Gw: 558-626 MHz Bw: 626-698 MHz Cw: 718-790 MHz Dw: 790-865MHz
Receiving frequencies	max. 32, tuneable in steps of 25 kHz
Switching bandwidth	≤ 88 MHz
Nominal/peak deviation	±24 kHz / ±48 kHz
Receiver principle	adaptive diversity
Sensitivity (with HDX, peak deviation)	< 4 μV, typ. < 1.6 μV for 52 dBA _{rms} S/N
Adjacent channel rejection	typ. 80 dB
Intermodulation attenuation	typ. 78 dB
Blocking	≥ 80 dB
Squelch	Low: 5 dBμV, Middle: 15 dBμV, High: 25 dBμV

AF characteristics for headphone output

Companer system	Sennheiser HDX
AF frequency response	40–15,000 Hz
S/N ratio (1 mV _{RF} , peak deviation)	approx. 90 dBA _{rms}
THD	≤ 0.9%
Headphone output	3.5 mm jack socket (mono, 2-pin, for headphones with at least 8 Ω)
Output power at 2.4 V, 5% THD and nominal deviation	100 mW at 32 Ω
Adjustment range	42 dB (6 dB steps) via potentiometer (+17 dBu reserve)

Overall device

Temperature range	–10°C to +55°C
Power supply	2 AA size batteries, 1.5 V or BA 2015 accupack
Nominal voltage	2.4 V ===
Power consumption: at nominal voltage with switched-off receiver	typ. 140 mA (±5%) ≤ 25 μA
Operating time with BA 2015 or bat- teries	approx. 8 hrs (depending on the volume set)

Dimensions
Weight (incl. batteries)

approx. 81 x 65 x 23 mm
approx. 200 g

Appendix

Radio frequencies

Channel	Frequency Ranges (MHz)				
	Aw+	Gw	Bw	Cw	Dw
1	470.100	558.100	630.100	718.100	863.100
2	470.500	558.500	630.500	718.500	863.500
3	472.000	561.600	633.600	721.600	864.300
4	473.600	563.900	635.900	723.900	864.900
5	475.900	564.500	636.500	724.500	823.000
6	476.500	565.700	637.700	725.700	823.450
7	486.100	559.000	631.000	719.000	824.000
8	486.500	560.000	632.000	720.000	824.700
9	488.000	574.100	646.100	734.100	825.550
10	489.600	574.500	646.500	734.500	826.050
11	491.900	577.600	649.600	737.600	827.550
12	492.500	579.900	651.900	739.900	828.450
13	493.700	580.500	652.500	740.500	829.200
14	502.200	581.700	653.700	741.700	830.300
15	502.600	575.000	647.000	735.000	830.950
16	504.100	576.000	648.000	736.000	831.900
17	505.700	590.200	662.200	750.200	...
18	508.000	590.600	662.600	750.600	...
19	508.600	593.700	665.700	753.700	...
20	509.800	596.000	668.000	756.000	...
21	518.100	596.600	668.600	756.600	...
22	518.500	597.800	669.800	757.800	...
23	521.600	591.100	663.100	751.100	...
24	523.900	592.100	664.100	752.100	...
25	524.500	606.100	678.100	766.100	...
26	525.700	606.500	678.500	766.500	...
27	536.850	609.600	681.600	769.600	...
28	538.625	611.900	683.900	771.900	...
29	548.550	612.500	684.500	772.500	...
30	551.775	613.700	685.700	773.700	...
31	552.475	607.000	679.000	767.000	...
32	553.800	608.000	680.000	768.000	...



Sennheiser electronic GmbH & Co. KG

Am Labor 1, 30900 Wedemark, Germany

www.sennheiser.com

Publ. 01/19