

→ For optimal diversity operation, it is recommended to use the same antenna model and equal coax cable length on both sides

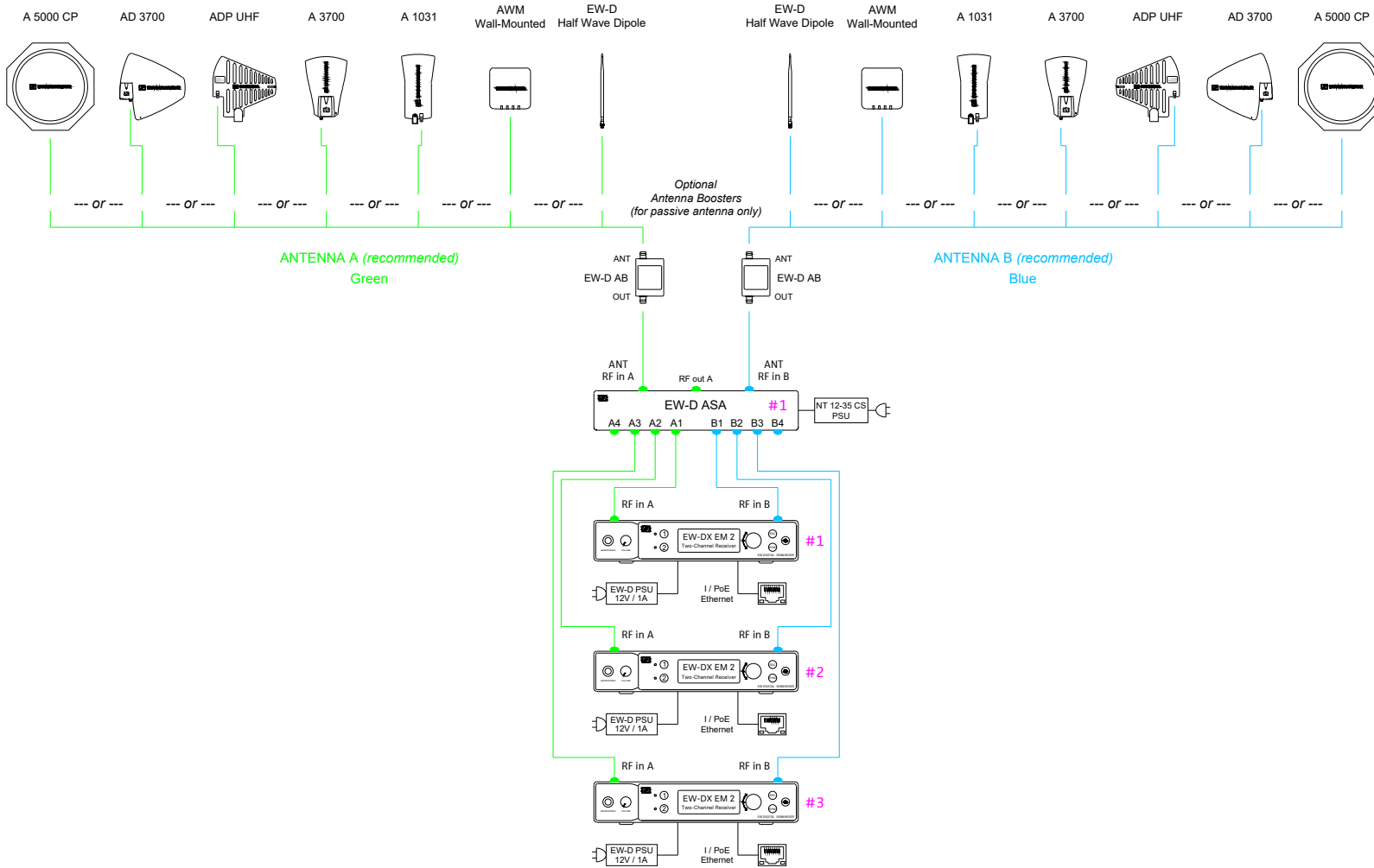

Evolution Wireless Digital
WIRELESS MICROPHONE SYSTEMS

Drawing name: EW-DX System Drawings
Revision: 1.0

Sheet title: RF Wiring and Antenna options

Description: 6-Channel System

EW-DX Available Frequency ranges	
Q1-9	470.2 - 550 MHz
R1-9	520 - 607.8 MHz
S1-10	606.2 - 693.8 MHz
S2-10	614.2 - 693.8 MHz
S4-10	630 - 693.8 MHz
U1/5	823.2 - 831.8 MHz 863.2 - 864.8 MHz
V3-4	925.2 - 937.3 MHz
V5-7	941.7 - 951.8 MHz 953.05 - 956.05 MHz 956.65 - 959.65 MHz
Y1-3	1785.2 - 1799.8 MHz

EW-D & EW-DX Accessories Frequency ranges	
EW-D ASA (Antenna Splitter, Active)	
Q-R-S	470 - 694 MHz
T-U-V-W	694 - 1075 MHz
X-Y	1350 - 1805 MHz
EW-D AB & EW-D Half Wave Dipole	
Q	470 - 550 MHz
R	520 - 608 MHz
S	606 - 694 MHz
U	823 - 865 MHz
V	902 - 960 MHz
Y	1785 - 1805 MHz

→ Please contact your local Sennheiser representative for available Evolution Wireless Digital frequency ranges in your market